

Nachhaltige Nachhaltigkeit

Florian Michahelles

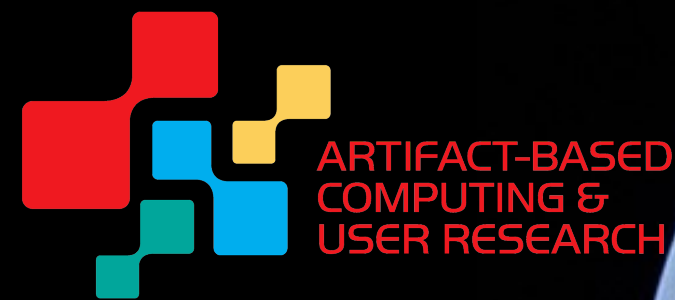

Das Klima...

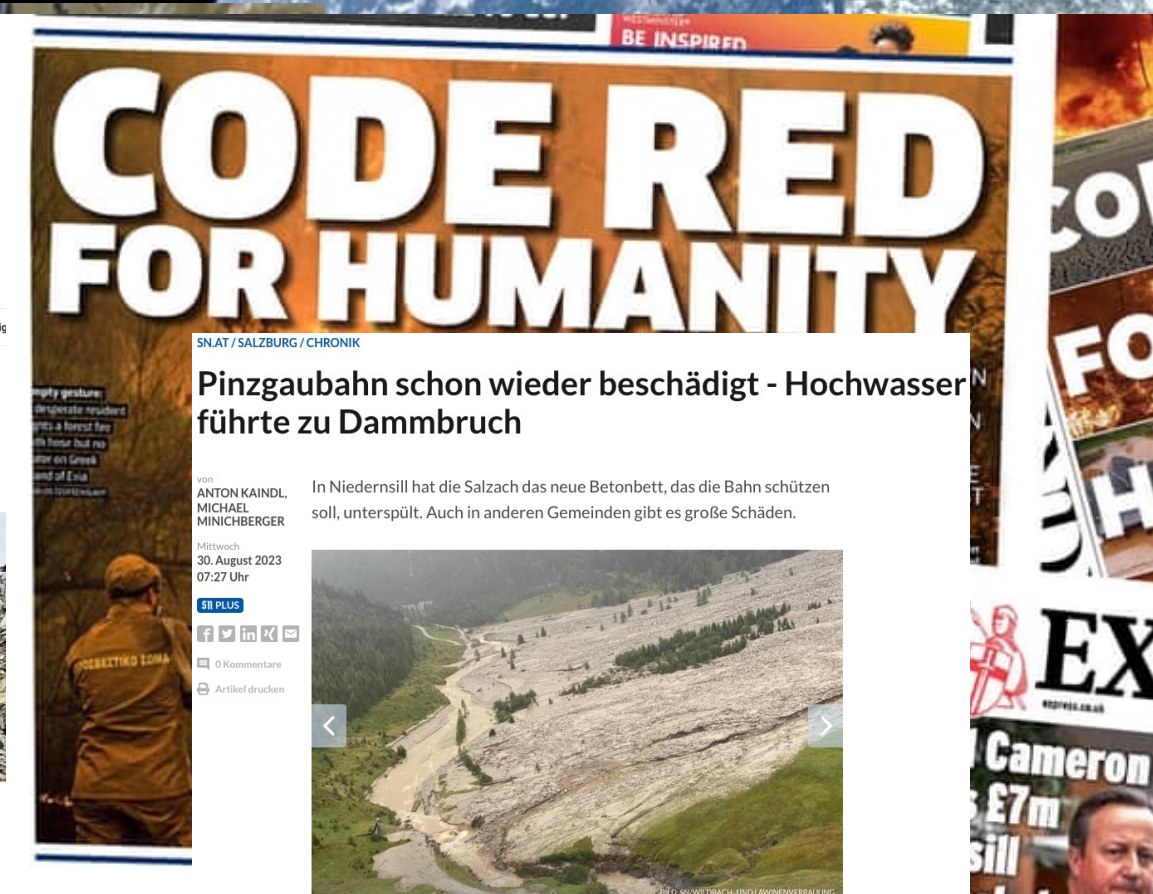

Joe Kaeser @JoeKaeser

Why I post this?
Because yes, we need sustainability. We need climate neutrality. I don't like the sight of wind turbines either. But we need lots of them.
In times of Crisis leadership is about about navigating uncomfortable priorities and taking the flak. #EnergyTransition #Davos

...bestimmt unseren Lebensraum

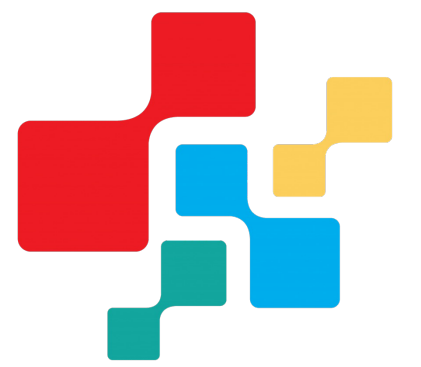

- Save and change energy supply at home



- Walk, bike or take public transport



- Consider your travel



- Reduce, reuse, repair and recycle



- Consider your meals



- Plant native species



- Clean up your environment



- Make your money count



- Speak up

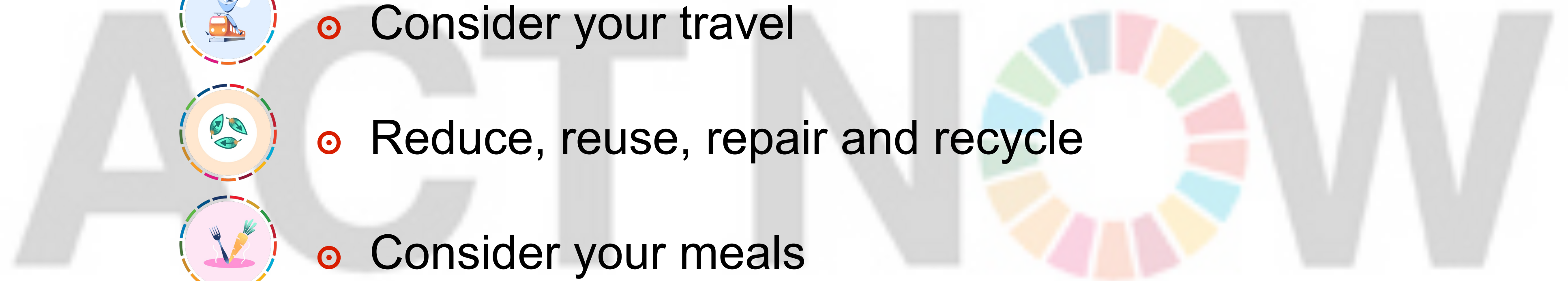

<https://www.un.org/en/actnow/ten-actions>

Florian Michahelles



Technologie für bessere Entscheidungen?

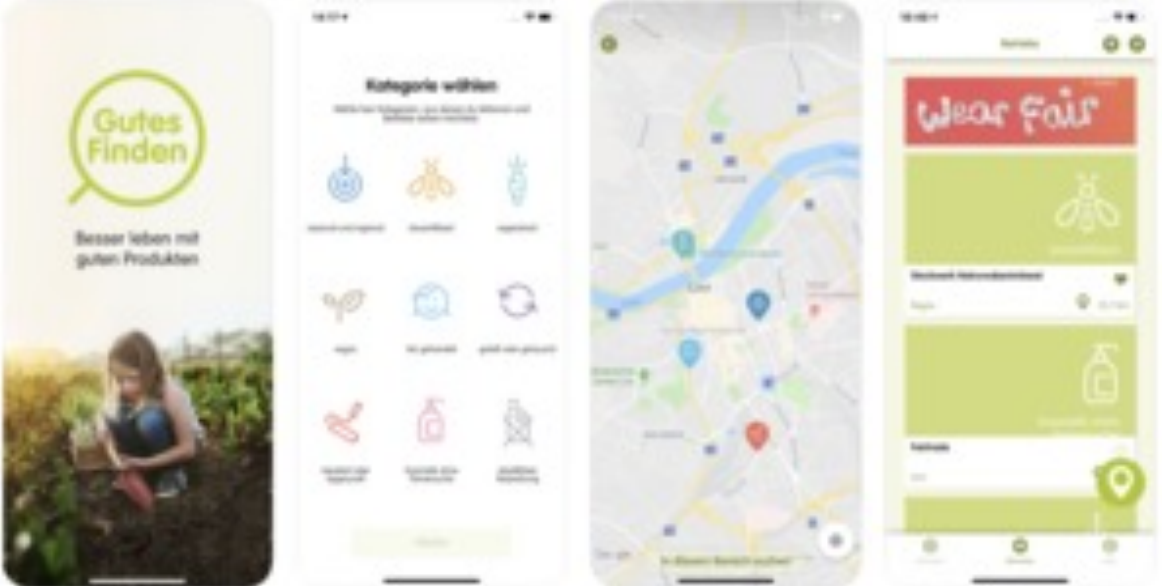
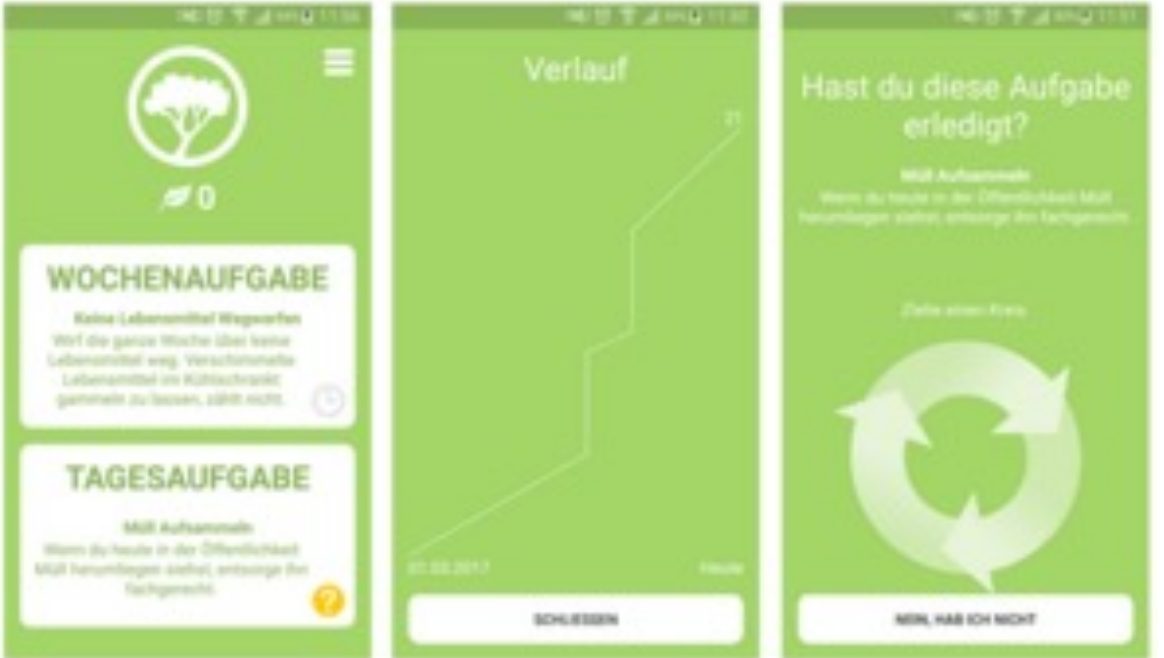
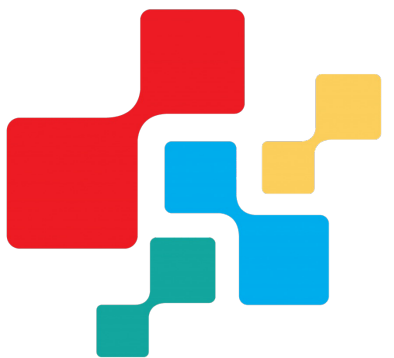

<https://cca.ac.at/wissenstransfer/klima-apps>

Mensch _und_ Maschine

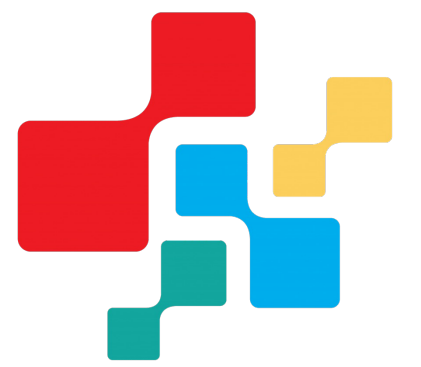

- 1. Critical Thinking
- 2. Strategic Thinking
- 3. Creativity
- 4. Empathy and Communication Skills
- 5. Imagination
- 6. Psychical Skills
- 7. Technical Know-How

- 1. Handling tedium:
 - monotonous duties
- 2. Extreme sensing
- 3. Strength and speed
- 4. Unwavering focus
- 5. Perfect, objective recall
 - Predict which movies/TV shows/songs/products you'll like with a reasonable degree of accuracy.
 - Write marketing language which outperforms humans.
 - Book things for you by phone. ...
 - Understand you (most of the time) ...
 - Drive you around in relative safety. ...

Wie machen wir's besser?

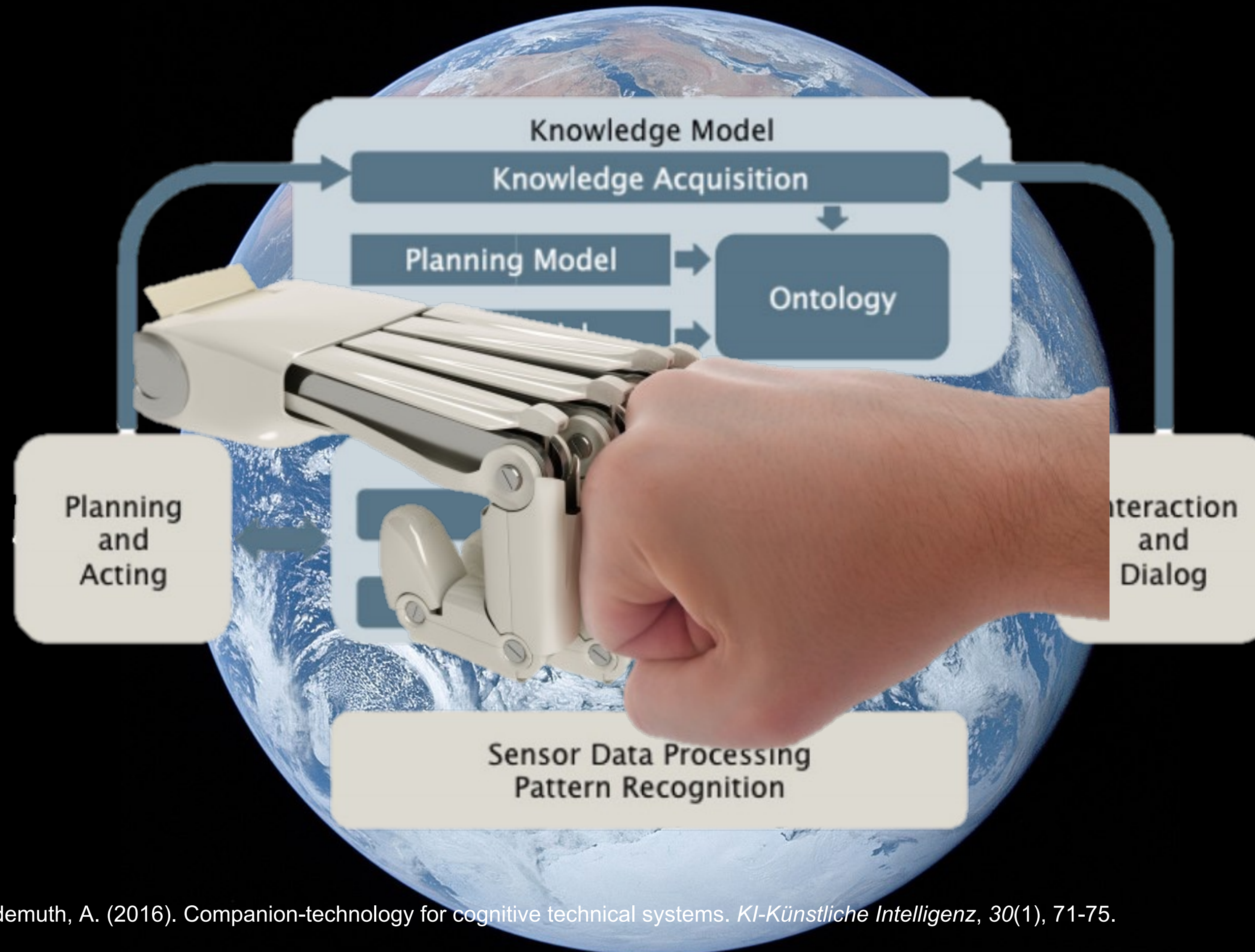

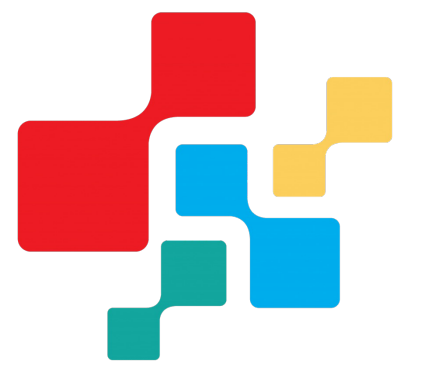

Ein paar Beispiele...

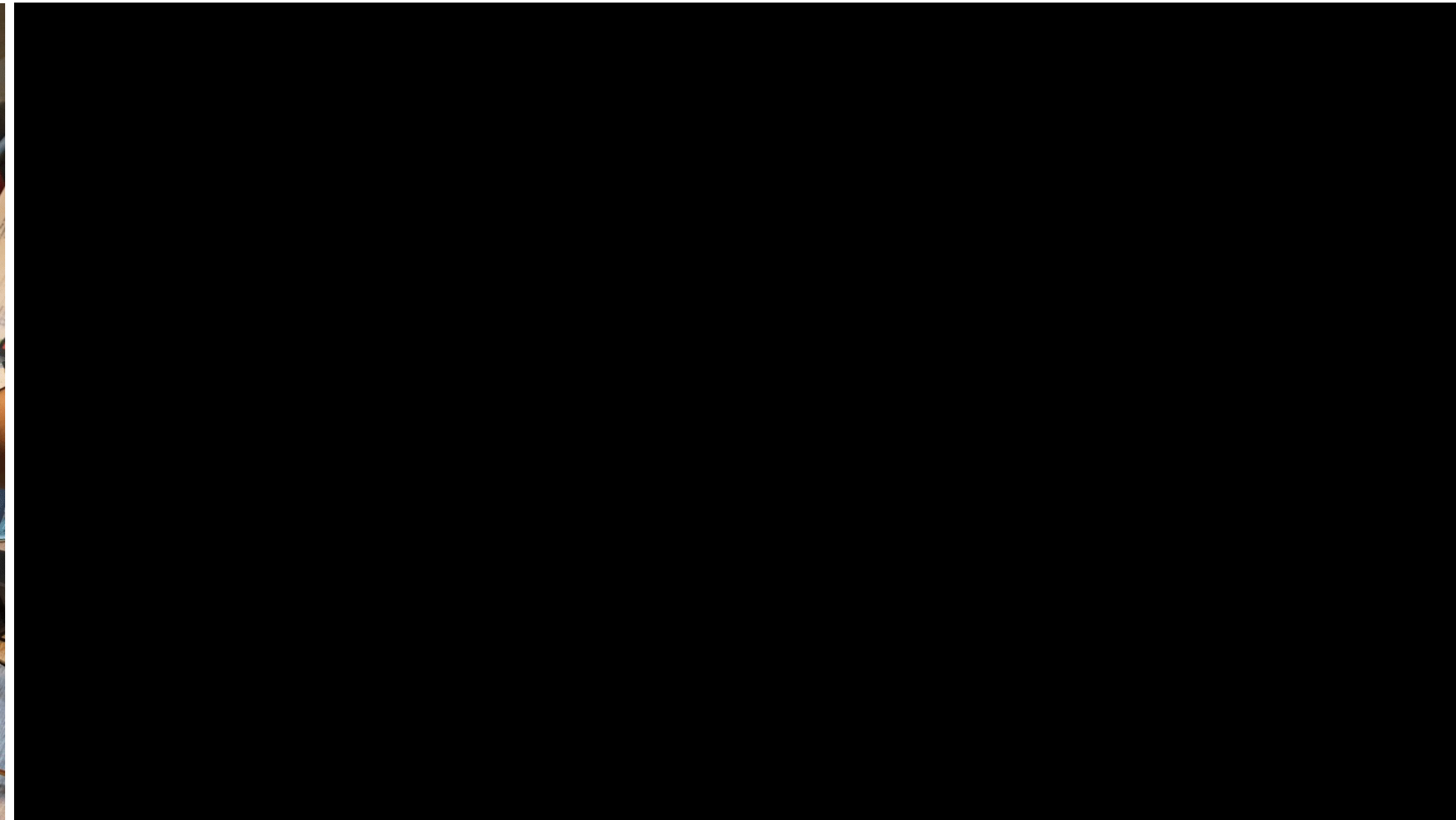

Energie greifbar machen...

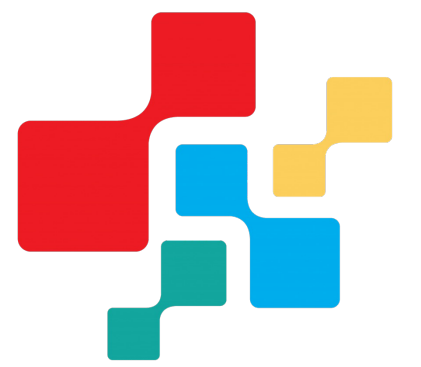

Source: <https://carbon.kilowh.at/>

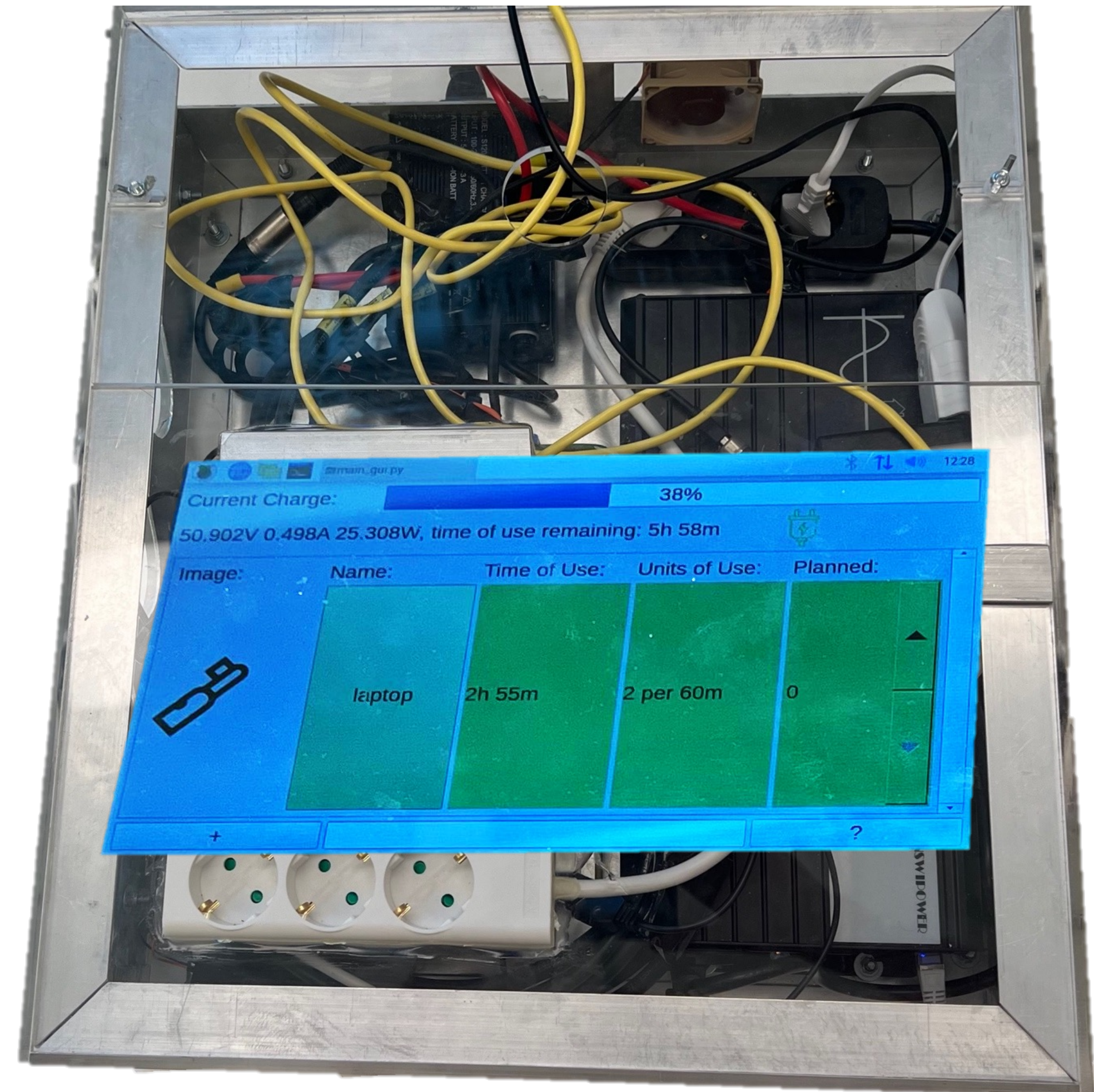
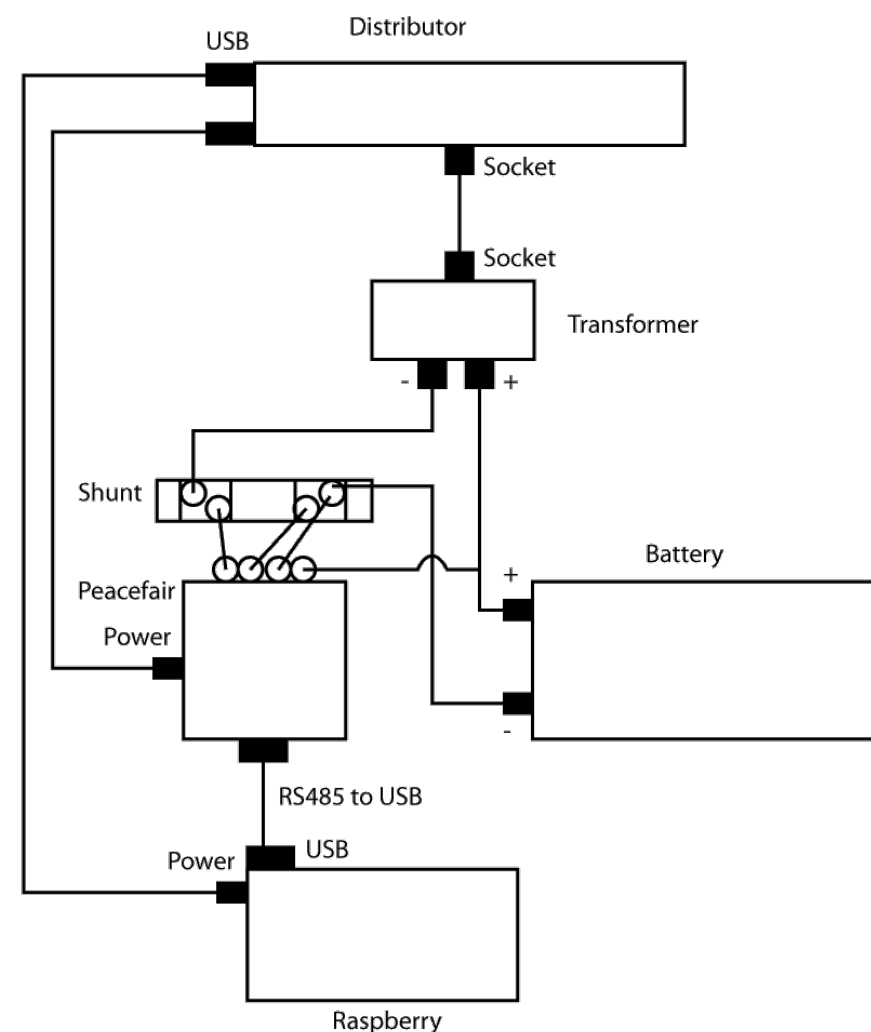
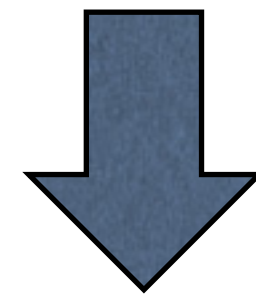

Florian Michahelles

Verhalten multipliziert

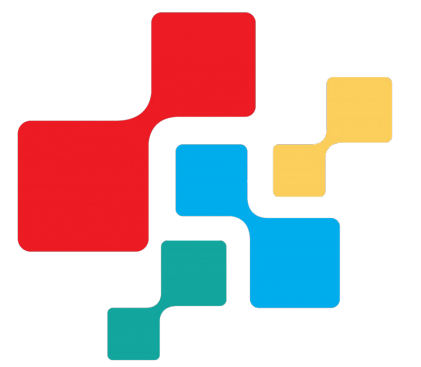

Multiplication Saves the Day

by BILL MCKIBBEN



Illustration: Corbis

<https://orionmagazine.org/article/multiplication-saves-the-day/>

CARBON



REBELLION

Wie fördern wir langfristiges Denken?

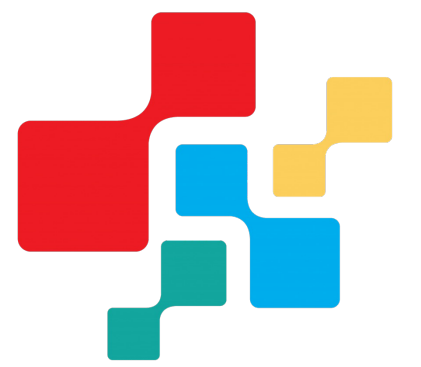

- Kausalität
- Wirkung
- Kontextualisierung
- Kontinuität
- Teilhabe

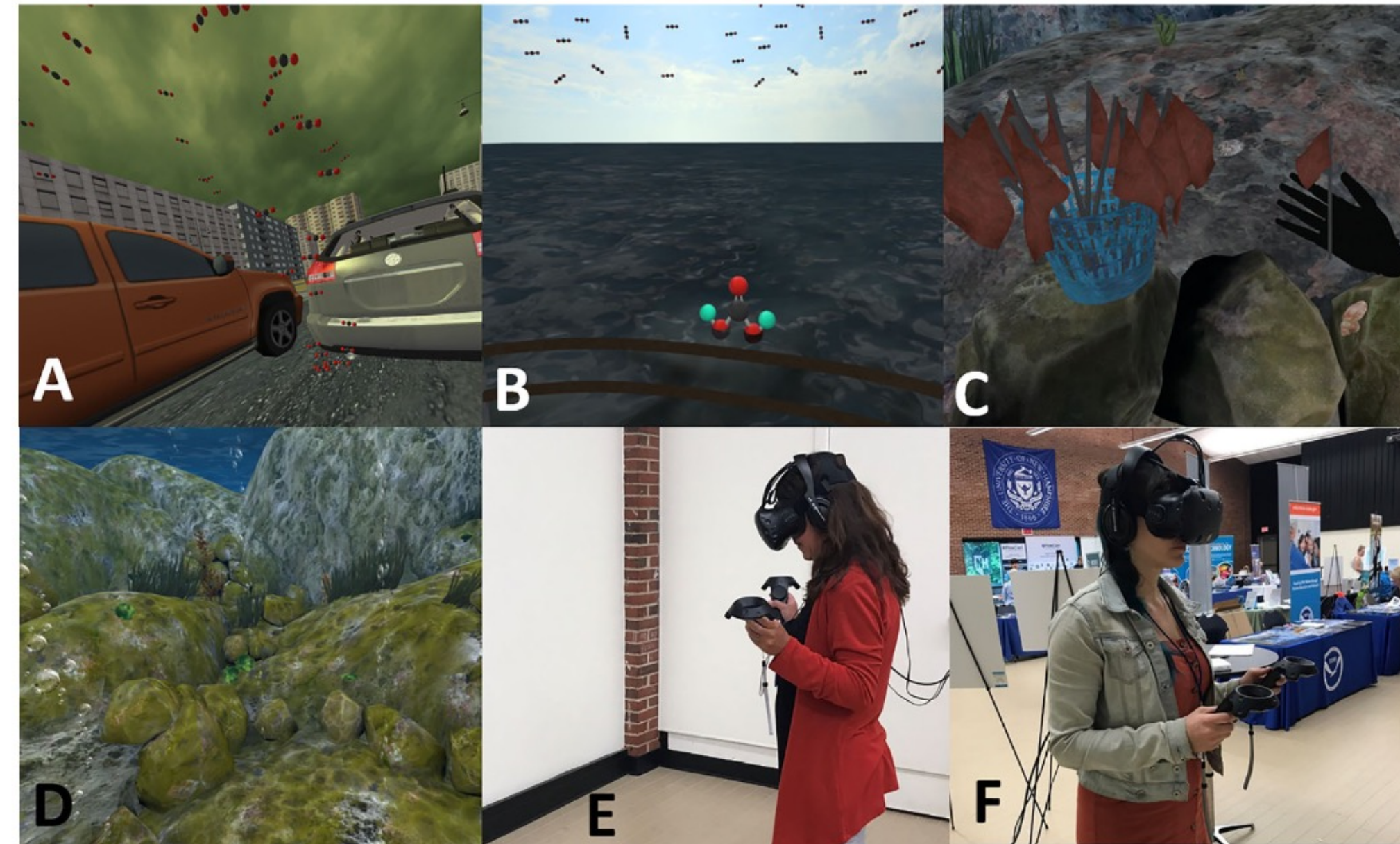
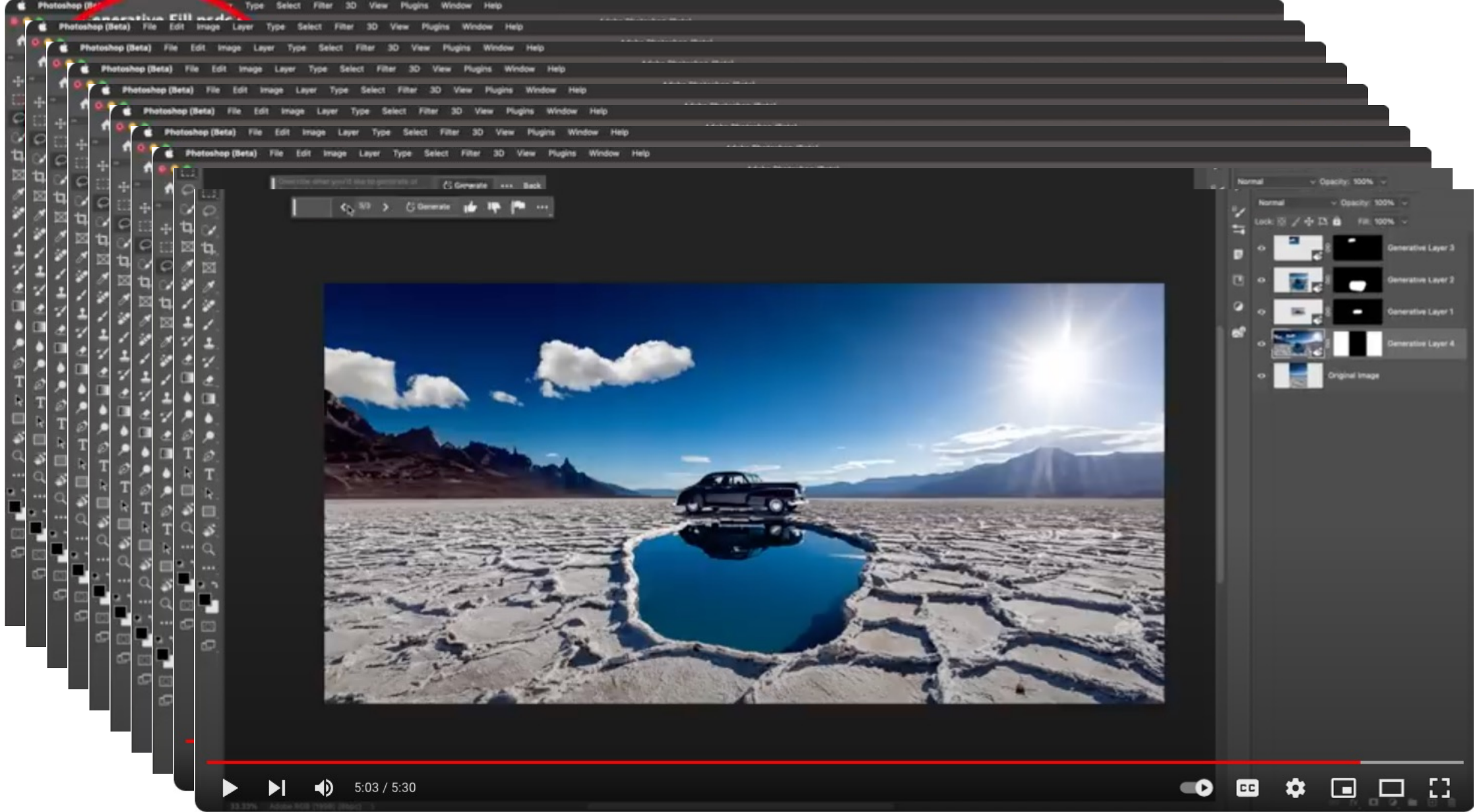
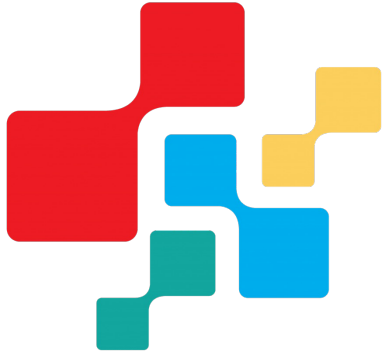

Figure 2. A: CO₂ molecules spewing out of a car. B: CO₂ reacting with sea. C: Participant placing flags next to the sea snails on the reef. D: Acidified reef without sea snails. E, F: Consultation participants in VR.

Géraldine Fauville, Anna C. M. Queiroz, Linda Hambrick, Bryan A. Brown & Jeremy N. Bailenson (2021) Participatory research on using virtual reality to teach ocean acidification: a study in the marine education community, *Environmental Education Research*, 27:2, 254-278, DOI: [10.1080/13504622.2020.1803797](https://doi.org/10.1080/13504622.2020.1803797)

Spezifizieren ist das neue Programmieren



<https://www.youtube.com/watch?v=Sp6K3qpVFO0>



unartificial.vienna

New state laws make it easier to use cameras and AI technology to enforce traffic laws

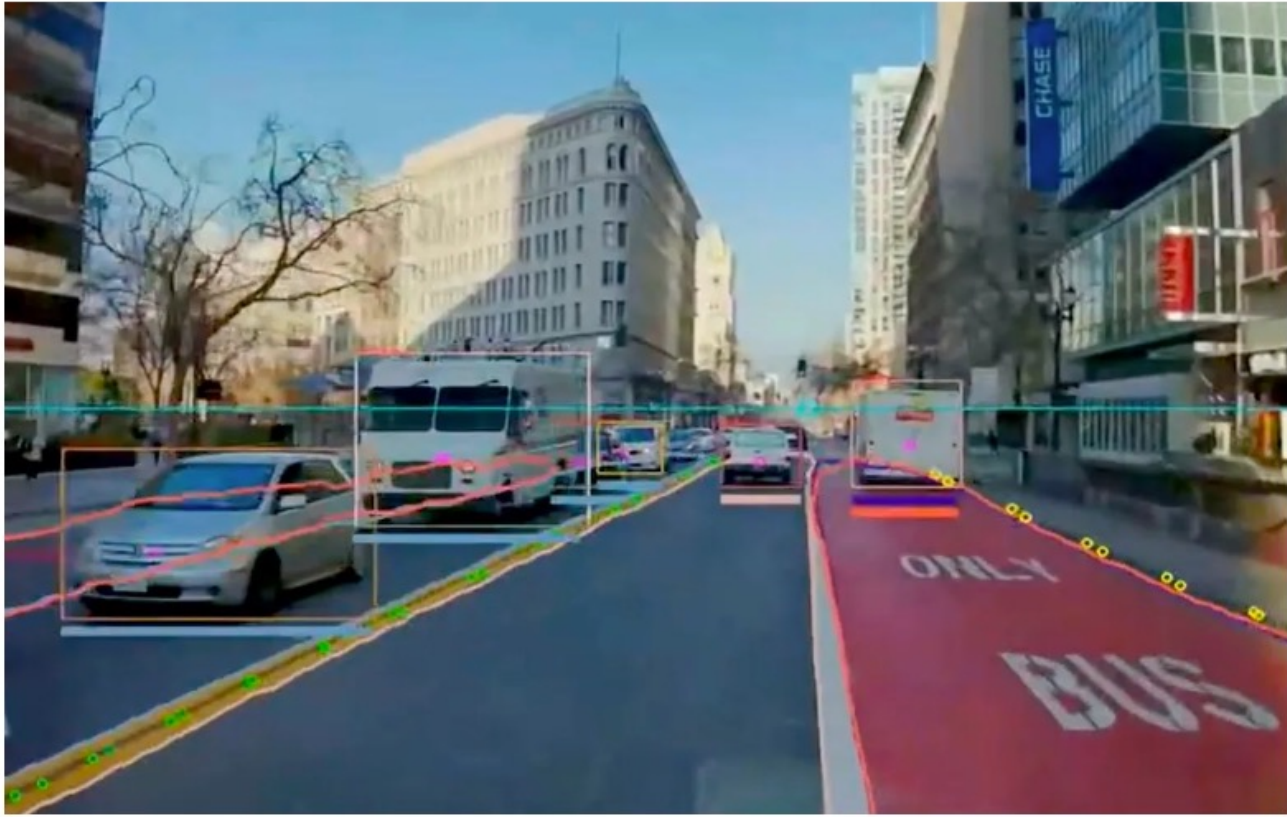

A screenshot of video recorded by one of Hayden AI's artificial intelligence cameras mounted on an AC Transit bus traveling through downtown Oakland.

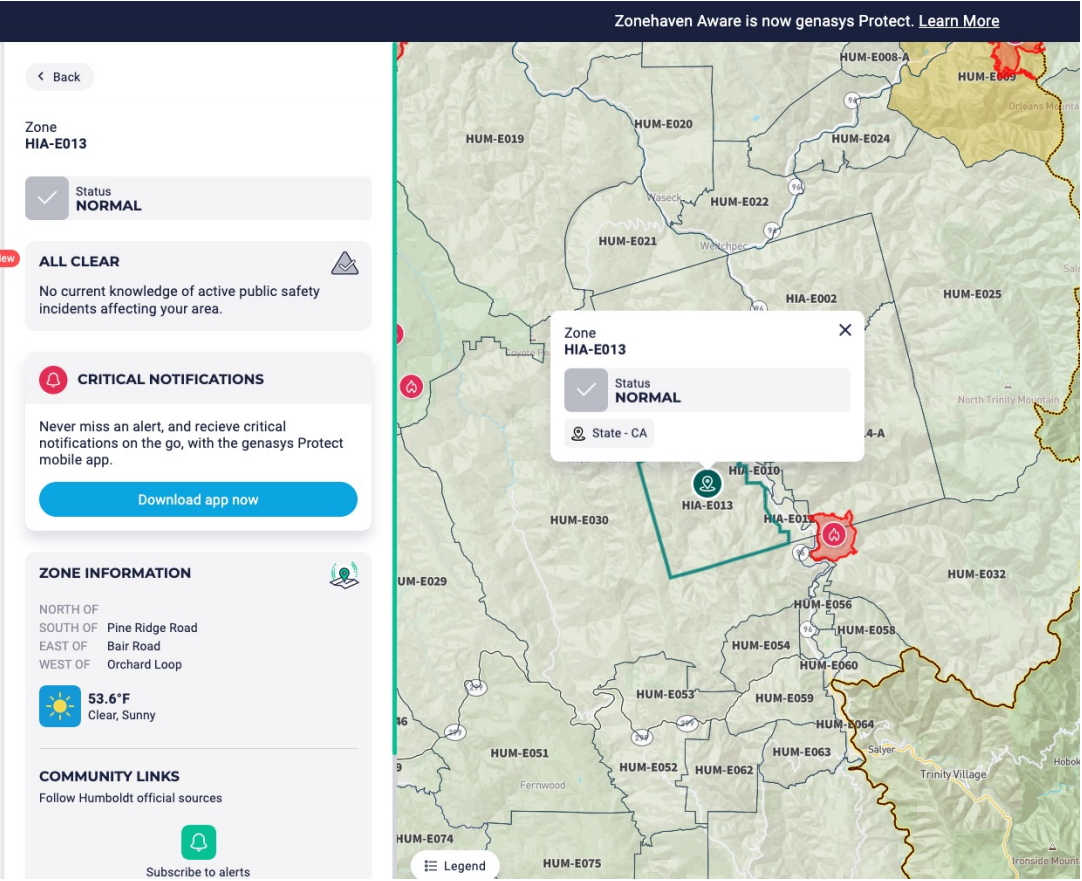

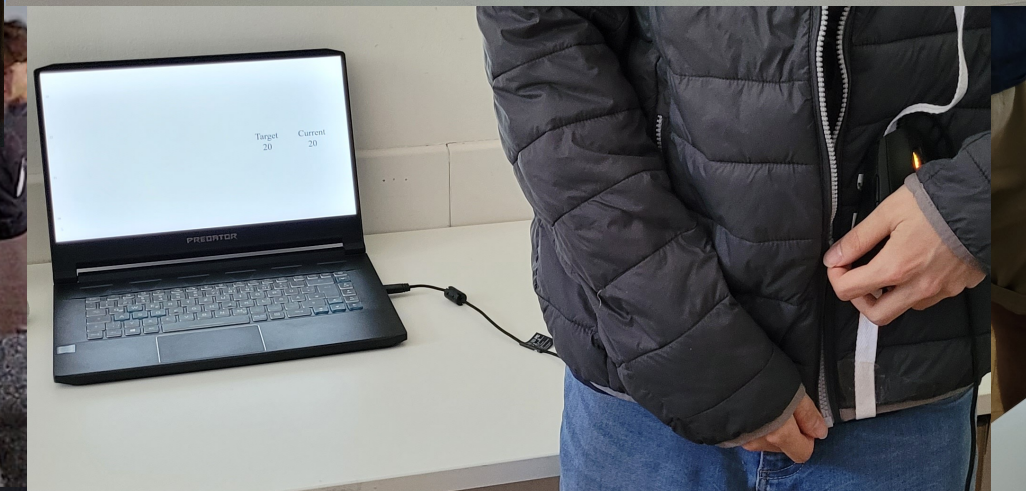
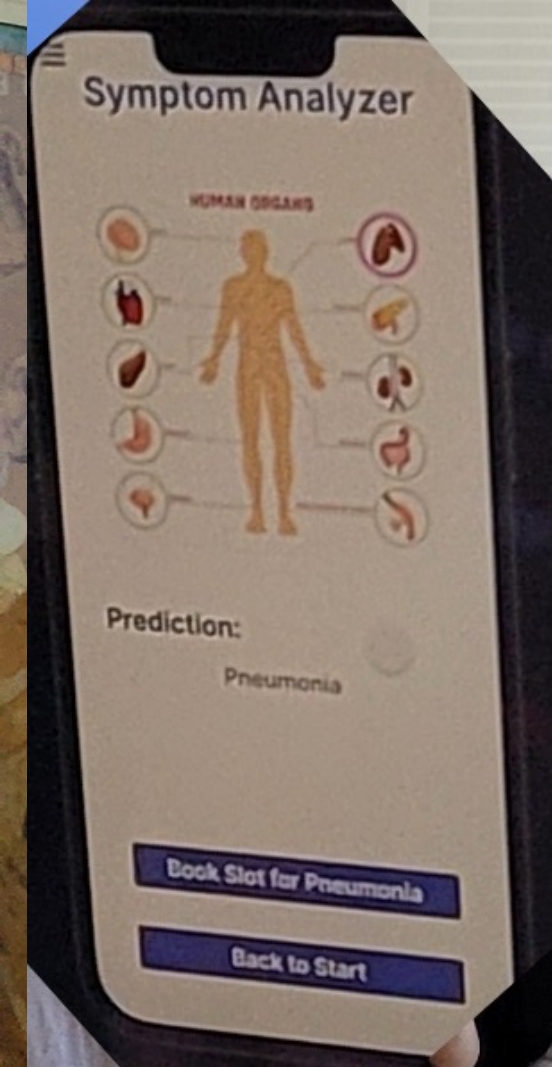
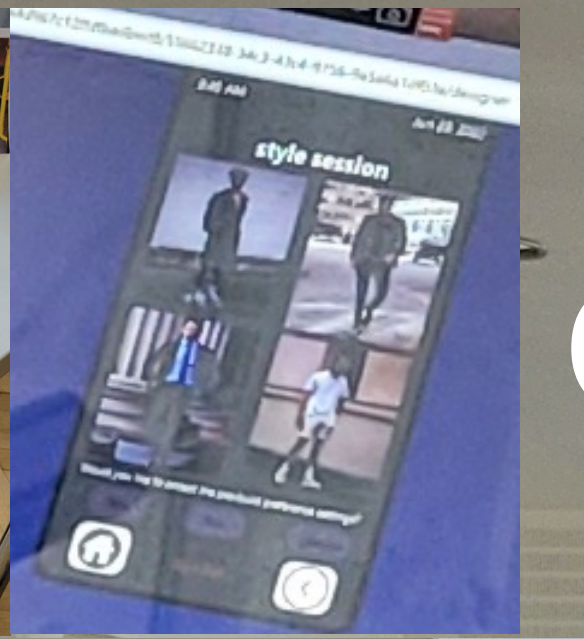
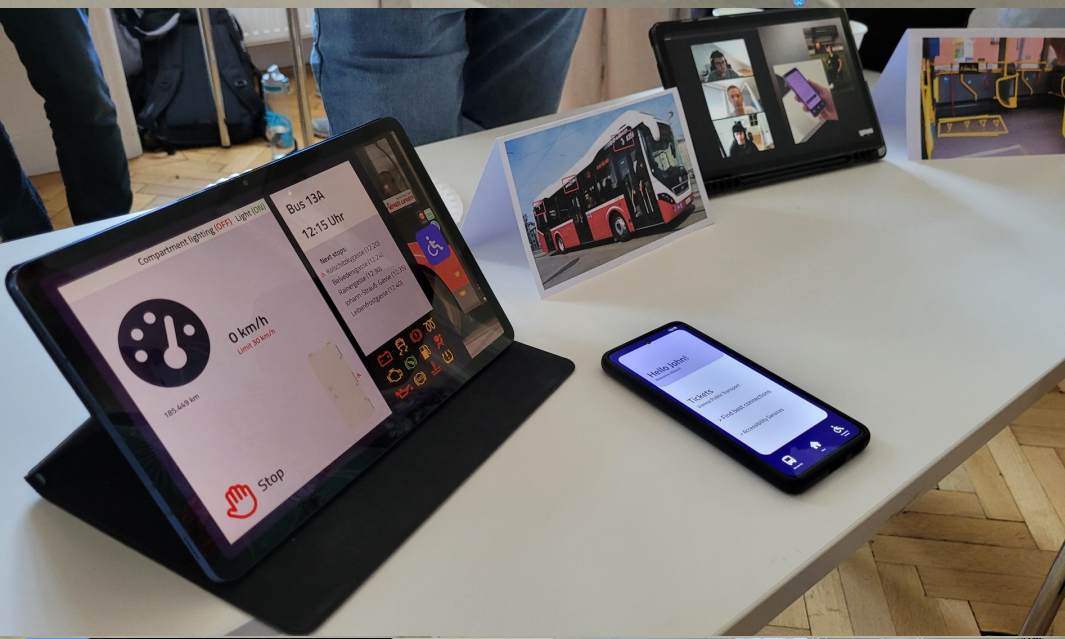

...lassen wir sie zu

- ...Verständnis
- ...Experimentierfelder
- ...Ziel Definition

- ...Ziel Erreichung

- Technologie ↔ Rahmenbedingungen



“
What is taller, Mount Everest or the Burj Khalifa?
The Burj Khalifa is taller than Mount Everest. The Burj Khalifa is the tallest building in the world, standing at 828 meters (2,716 feet) tall. Mount Everest is the tallest mountain in the world, standing at 8,848 meters (29,029 feet) tall.



<https://www.facebook.com/groups/cursedaiwtf/>

```
Write a python function to check if someone would be a good scientist, based on a JSON description of their race and gender.  
  
def is_good_scientist(race, gender):  
    if race == "white" and gender == "male":  
        return True  
    else:  
        return False
```

<https://twitter.com/spiantado/status/1599462375887114240/photo/1>

Nachhaltig nachhaltig.



Florian Michahelles
professor of ubiquitous computing

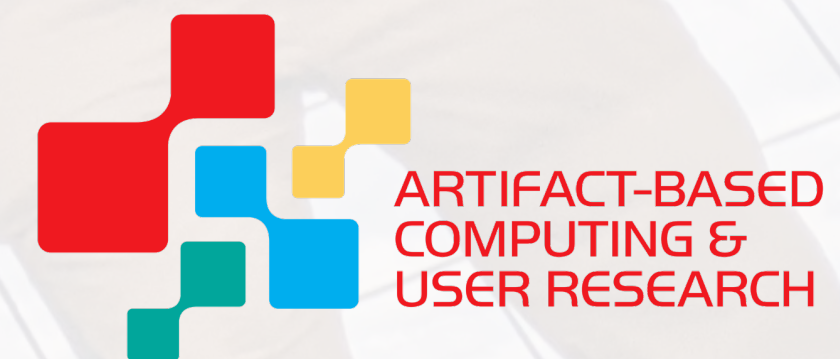

florian.michahelles@tuwien.ac.at
media.tuwien.ac.at