



TECHNISCHE  
UNIVERSITÄT  
WIEN

Vienna University of Technology

## **DIPLOMARBEIT**

# **Synthesis and Characterisation of Novel Donor-functionalised Group 13 Alkoxides for CVD Applications**

Ausgeführt am Institut für  
Materialchemie  
der Technischen Universität Wien

unter Anleitung von  
O. Univ. Prof. Dipl.-Ing. Dr. rer. nat Ulrich Schubert  
Dipl.-Chem. Dr. rer. nat. Sven Barth

durch  
Felix BIEGGER, BSc.

Fröbelgasse 62/10  
1160 Wien

Wien, Januar 2013



The 'paradox' is only a conflict between reality  
and your feeling what reality 'ought to be'.

Richard Feynman





## **EIDESSTATTLICHE ERKLÄRUNG**

---

Ich erkläre hiermit an Eides statt, dass ich die vorliegende Diplomarbeit selbstständig und ohne fremde Hilfe verfasst, andere als die angegebenen Quellen und Hilfsmittel nicht benutzt und die den benutzten Quellen wörtlich und inhaltlich entnommenen Stellen als solche erkenntlich gemacht habe.

## **STATUTORY DECLARATION**

---

I herewith declare that I have authored this thesis independently, that I have not used other than the declared sources / resources, and that I have explicitly marked all material which has been quoted either literally or by content from the used sources.

# ACKNOWLEDGMENT

---

I want to thank ...

... my supervisor Dr. Sven Barth for giving me the opportunity to work on an interesting, up-to-date topic, for his guidance, supervision and patience, but also for sharing his knowledge and experimental expertise, always having an open door and encouraging me to pursue my own ideas.

... Prof. Dr. U. Schubert for being my thesis' supervisor and for giving me the chance to work within his research group.

... my parents and family without whom my studies and this work would not have been possible. For their financial support throughout my studies, always supporting my choice to study chemistry (without having any idea of what I am doing here), their words of encouragement and help with the layout of this work, I will always be grateful.

... my colleagues at the Institute of Materials Chemistry for always having a sympathetic ear for my problems, stories and my whining about not-working reactions.

... Stefan E. for being a superb lab buddy throughout the thesis, for always helping me and bearing my music all day long.

... Christian M. for being the go-to-guy of our group, who always knows where to find everything and for organising everything.

... Matthias C. for his tips regarding synthesis.

... Martin K. for always sharing his glassware.

... Christine A. for XRD measurements.

... Johannes K. for conducting experiments smelling as badly as mine.

... Elisabeth F., Maia G., Sarah M., Aparna D., Miriam, U., Yingzia Y. and Rupali D. for making work at the institute an enjoyable experience.

... Michael S. for conducting some of the experiments.

... Stephan R. for steady supply of chemicals and materials, Rupert K. for maintenance of pumps and other equipment, Michael P. for help with advanced NMR experiments, Harald S. for IT-support and Horst L. for his amazing work fixing uncountable broken glass parts.

... my friends Dennis S., Paul K. and Theresa W. in the department of organic chemistry for conducting GC/MS experiments and for finding time to talk about alternative reaction procedures and synthesis strategies.

... all of my friends (chemists and otherwise) for making the time in Vienna an unforgettable experience and for helping me throughout my studies – be it studying together for maths or sharing a beer and a laugh in the evenings. Philipp D. has my thanks for sharing my distinguished taste in music and for proofreading this thesis.

# ABSTRACT

---

This work contains first data describing a stabilisation of alkoxides with low molecularity by coordination of thioether donors. The investigations include the synthesis of 15 new secondary and tertiary donor-functionalised alcohols, which are mandatory compounds to study the coordination behaviour. In the course of this thesis, 30 novel gallium and indium alkoxides have been synthesised and their purity has been confirmed by NMR spectroscopy. The ligand species have been thoroughly characterised via NMR spectroscopy, mass spectrometry and IR spectroscopy.

Symmetric thioether-donor bearing alkoxides exhibit only weak sulphur-metal interaction leading to strong fluctuation of the sulphur-metal coordination in solution. Further evidence of the thioether coordination to an indium metal centre at room temperature is provided by single crystal X-ray diffraction. However, there are no signs of thioether coordination in a competitive environment with amine donors. These investigations are based on asymmetrically substituted alcoholate species bearing both functionalities in one molecule allowing us to draw conclusions according to NMR data.

In addition, TGA experiments using novel alkoxides show single or two-step decomposition at standard pressure. Specifically the asymmetric alcoholates could be interesting, because activated species could lead to unexpected decomposition behaviour under reduced pressure. The decomposition patterns of some symmetrical thioether-functionalised metal alkoxides are promising and lead to the conclusion that high quality oxide coatings could be prepared with such precursors. CVD is a targeted application of the novel precursor species, which prompted us to investigate the decomposition characteristics of indium(III)tert.-butanolate. The properties of the obtained  $\text{In}_2\text{O}_3$  coatings will be used as reference specimen for future experiments using the novel alkoxides described in this thesis.

## KURZFASSUNG

---

Diese Arbeit beschreibt erstmalig die Untersuchung von Thioethern als Donoren in der Alkoxidesynthese zur Stabilisierung von niedermolekularen Spezies. Es wird eine Synthesestrategie und die Herstellung von 15 neuartigen sekundären und tertiären  $\beta$ -donor funktionalisierten Alkoholen beschrieben, welche als Vorstufen zur Herstellung der jeweiligen Gallium- und Indiumalkoxide verwendet wurden. Es konnten somit 30 neue Alkoxide synthetisiert werden, deren Reinheit durch NMR-Spektroskopie bestätigt werden konnte. Die Charakterisierung der Alkohole umfasste sowohl  $^1\text{H}$ - und  $^{13}\text{C}$ - NMR-Spektroskopie, als auch Massenspektrometrie und IR Spektroskopie.

Symmetrische Thioether-funktionalisierte Alkoxide weisen anhand von NMR Daten eine schwache Schwefel-Metall Wechselwirkung auf, die in Lösung zu einer stark fluktuierenden Koordination führt. Die tatsächlichen Koordinationstendenzen konnten ebenfalls durch Einkristallröntgendiffraktometrie an einem der Indiumalkoxide eindeutig nachgewiesen werden. Im Gegensatz dazu zeigen unsymmetrisch substituierte Alkoxide, welche sowohl über Thioether- als auch über Amin-Funktionalitäten verfügen, ausschließlich eine Koordination des Stickstoff-Donors. Anhand der NMR Daten kann davon ausgegangen werden, dass bei diesen Spezies eine Schwefel-Metall Wechselwirkung unterdrückt wird.

Das Zersetzungsverhalten bei Normaldruck zeigt anhand von TGA Daten ein- oder zweistufige Übergänge bei relative niedrigen Temperaturen. Rückschlüsse können hierbei besonders auf eine Verwendbarkeit der unsymmetrisch substituierten Verbindungen gezogen werden, die mitunter zur Erzeugung von aktivierten Spezies verwendet werden könnten. Das thermische Verhalten weist darüber hinaus darauf hin, dass sich ausgewählte Verbindungen für die Verwendung als Vorstufen in einem CVD Prozess zur Erzeugung von Oxidschichten gut eignen. In diesem Zusammenhang wird die Herstellung und Charakterisierung von  $\text{In}_2\text{O}_3$  Filmen ausgehend von Indium(III)tert.-butanolat beschrieben, welche als Referenzen für künftige CVD Untersuchungen der hier beschriebenen neuen Alkoxide dienen sollen.

## ABBREVIATIONS

---

<b>acac</b>	acetylacetonate	<b>HMDS</b>	hexamethyldisilazane
<b>approx.</b>	approximately	<b>IR</b>	infrared
<b>ALD</b>	atomic layer deposition	<b>Me</b>	methyl
<b>ATR</b>	attenuated total reflection	<b>MS</b>	mass spectrometry
<b><sup>n</sup>Bu</b>	<i>normal</i> -butyl	<b>NMR</b>	nuclear magnetic resonance
<b><sup>t</sup>Bu</b>	<i>tertiary</i> -butyl	<b>NEt<sub>3</sub></b>	triethylamine
<b>CVD</b>	chemical vapour deposition	<b>O<sup>t</sup>Bu</b>	tertiary butoxide
<b>equiv.</b>	equivalent	<b><sup>i</sup>Pr</b>	isopropyl
<b>Et</b>	ethyl	<b>PVD</b>	physical vapour deposition
<b>etc.</b>	et cetera	<b>TGA</b>	thermogravimetric analysis
<b>FTIR</b>	Fourier transform infrared	<b>THF</b>	tetrahydrofuran
<b>GC/MS</b>	gas chromatography/mass spectrometry	<b>XRD</b>	X-ray diffraction

### NMR Abbreviations

<b>δ</b>	chemical shift	<b>s</b>	strong
<b>s</b>	singlet	<b>m</b>	medium
<b>d</b>	doublet	<b>w</b>	weak
<b>t</b>	triplet	<b>br</b>	broad
<b>q</b>	quartet	<b>v</b>	wave number
<b>quint.</b>	quintet		
<b>m</b>	multiplet		
<b>ppm</b>	parts per million		

## LIST OF COMPOUNDS

Nr.	Molecular formula	Nr.	Molecular formula
1	(ClCH <sub>2</sub> )( <sup>i</sup> C <sub>3</sub> H <sub>7</sub> SCH <sub>2</sub> )CHOH	32	In(O <sup>t</sup> Bu) <sub>3</sub>
2	( <sup>i</sup> C <sub>3</sub> H <sub>7</sub> SCH <sub>2</sub> )CHCH <sub>2</sub> O	33	Ga[OCH(CH <sub>2</sub> S <sup>i</sup> C <sub>3</sub> H <sub>7</sub> ) <sub>2</sub> ] <sub>3</sub>
3	( <sup>i</sup> C <sub>3</sub> H <sub>7</sub> SCH <sub>2</sub> ) <sub>2</sub> CHOH	34	Ga[OCH(CH <sub>2</sub> S <sup>n</sup> C <sub>4</sub> H <sub>9</sub> ) <sub>2</sub> ] <sub>3</sub>
4	( <sup>i</sup> C <sub>3</sub> H <sub>7</sub> SCH <sub>2</sub> )((C <sub>2</sub> H <sub>5</sub> ) <sub>2</sub> N)CHOH	35	Ga[OCH(CH <sub>2</sub> S <sup>t</sup> C <sub>4</sub> H <sub>9</sub> ) <sub>2</sub> ] <sub>3</sub>
5	(ClCH <sub>2</sub> )( <sup>n</sup> C <sub>4</sub> H <sub>9</sub> SCH <sub>2</sub> )CHOH	36	Ga[OCH(CH <sub>2</sub> S <sup>i</sup> C <sub>3</sub> H <sub>7</sub> )(CH <sub>2</sub> N(C <sub>2</sub> H <sub>5</sub> ) <sub>2</sub> )] <sub>3</sub>
6	( <sup>n</sup> C <sub>4</sub> H <sub>9</sub> SCH <sub>2</sub> )CHCH <sub>2</sub> O	37	Ga[OCH(CH <sub>2</sub> S <sup>n</sup> C <sub>4</sub> H <sub>9</sub> )(CH <sub>2</sub> N(C <sub>2</sub> H <sub>5</sub> ) <sub>2</sub> )] <sub>3</sub>
7	( <sup>n</sup> C <sub>4</sub> H <sub>9</sub> SCH <sub>2</sub> ) <sub>2</sub> CHOH	38	Ga[OCH(CH <sub>2</sub> S <sup>t</sup> C <sub>4</sub> H <sub>9</sub> )(CH <sub>2</sub> N(C <sub>2</sub> H <sub>5</sub> ) <sub>2</sub> )] <sub>3</sub>
8	( <sup>n</sup> C <sub>4</sub> H <sub>9</sub> SCH <sub>2</sub> )((C <sub>2</sub> H <sub>5</sub> ) <sub>2</sub> N)CHOH	39	In[OCH(CH <sub>2</sub> S <sup>i</sup> C <sub>3</sub> H <sub>7</sub> ) <sub>2</sub> ] <sub>3</sub>
9	(ClCH <sub>2</sub> )( <sup>t</sup> C <sub>4</sub> H <sub>9</sub> SCH <sub>2</sub> )CHOH	40	In[OCH(CH <sub>2</sub> S <sup>n</sup> C <sub>4</sub> H <sub>9</sub> ) <sub>2</sub> ] <sub>3</sub>
10	( <sup>t</sup> C <sub>4</sub> H <sub>9</sub> SCH <sub>2</sub> )CHCH <sub>2</sub> O	41	In[OCH(CH <sub>2</sub> S <sup>t</sup> C <sub>4</sub> H <sub>9</sub> ) <sub>2</sub> ] <sub>3</sub>
11	( <sup>t</sup> C <sub>4</sub> H <sub>9</sub> SCH <sub>2</sub> ) <sub>2</sub> CHOH	42	In[OCH(CH <sub>2</sub> S <sup>i</sup> C <sub>3</sub> H <sub>7</sub> )(CH <sub>2</sub> N(C <sub>2</sub> H <sub>5</sub> ) <sub>2</sub> )] <sub>3</sub>
12	( <sup>t</sup> C <sub>4</sub> H <sub>9</sub> SCH <sub>2</sub> )((C <sub>2</sub> H <sub>5</sub> ) <sub>2</sub> N)CHOH	43	In[OCH(CH <sub>2</sub> S <sup>n</sup> C <sub>4</sub> H <sub>9</sub> )(CH <sub>2</sub> N(C <sub>2</sub> H <sub>5</sub> ) <sub>2</sub> )] <sub>3</sub>
13	(ClCH <sub>2</sub> ) <sub>2</sub> (C <sub>2</sub> H <sub>5</sub> )COH	44	In[OCH(CH <sub>2</sub> S <sup>t</sup> C <sub>4</sub> H <sub>9</sub> )(CH <sub>2</sub> N(C <sub>2</sub> H <sub>5</sub> ) <sub>2</sub> )] <sub>3</sub>
14	(ClCH <sub>2</sub> )(C <sub>2</sub> H <sub>5</sub> )CCH <sub>2</sub> O	45	Ga[OC(CH <sub>2</sub> OC <sub>2</sub> H <sub>5</sub> ) <sub>2</sub> (C <sub>2</sub> H <sub>5</sub> )] <sub>3</sub>
15	(C <sub>2</sub> H <sub>5</sub> )(C <sub>2</sub> H <sub>5</sub> OCH <sub>2</sub> ) <sub>2</sub> COH	46	Ga[OC(CH <sub>2</sub> SC <sub>2</sub> H <sub>5</sub> ) <sub>2</sub> (C <sub>2</sub> H <sub>5</sub> )] <sub>3</sub>
16	(C <sub>2</sub> H <sub>5</sub> )(C <sub>2</sub> H <sub>5</sub> SCH <sub>2</sub> ) <sub>2</sub> COH	47	Ga[OC(CH <sub>2</sub> S <sup>i</sup> C <sub>3</sub> H <sub>7</sub> ) <sub>2</sub> (C <sub>2</sub> H <sub>5</sub> )] <sub>3</sub>
17	(C <sub>2</sub> H <sub>5</sub> )(C <sub>2</sub> H <sub>5</sub> SCH <sub>2</sub> )CCH <sub>2</sub> O	48	Ga[OC(CH <sub>2</sub> S <sup>n</sup> C <sub>4</sub> H <sub>9</sub> ) <sub>2</sub> (C <sub>2</sub> H <sub>5</sub> )] <sub>3</sub>
18	(C <sub>2</sub> H <sub>5</sub> )( <sup>i</sup> C <sub>3</sub> H <sub>7</sub> SCH <sub>2</sub> ) <sub>2</sub> COH	49	Ga[OC(CH <sub>2</sub> S <sup>t</sup> C <sub>4</sub> H <sub>9</sub> ) <sub>2</sub> (C <sub>2</sub> H <sub>5</sub> )] <sub>3</sub>
19	(C <sub>2</sub> H <sub>5</sub> )( <sup>i</sup> C <sub>3</sub> H <sub>7</sub> SCH <sub>2</sub> )CCH <sub>2</sub> O	50	Ga[OC(CH <sub>2</sub> SC <sub>2</sub> H <sub>5</sub> )(CH <sub>2</sub> N(C <sub>2</sub> H <sub>5</sub> ) <sub>2</sub> )(C <sub>2</sub> H <sub>5</sub> )] <sub>3</sub>
20	(C <sub>2</sub> H <sub>5</sub> )( <sup>n</sup> C <sub>4</sub> H <sub>9</sub> SCH <sub>2</sub> ) <sub>2</sub> COH	51	Ga[OC(CH <sub>2</sub> S <sup>i</sup> C <sub>3</sub> H <sub>7</sub> )(CH <sub>2</sub> N(C <sub>2</sub> H <sub>5</sub> ) <sub>2</sub> )(C <sub>2</sub> H <sub>5</sub> )] <sub>3</sub>
21	(C <sub>2</sub> H <sub>5</sub> )( <sup>n</sup> C <sub>4</sub> H <sub>9</sub> SCH <sub>2</sub> )CCH <sub>2</sub> O	52	Ga[OC(CH <sub>2</sub> S <sup>n</sup> C <sub>4</sub> H <sub>9</sub> )(CH <sub>2</sub> N(C <sub>2</sub> H <sub>5</sub> ) <sub>2</sub> )(C <sub>2</sub> H <sub>5</sub> )] <sub>3</sub>
22	(C <sub>2</sub> H <sub>5</sub> )( <sup>t</sup> C <sub>4</sub> H <sub>9</sub> SCH <sub>2</sub> ) <sub>2</sub> COH	53	Ga[OC(CH <sub>2</sub> S <sup>t</sup> C <sub>4</sub> H <sub>9</sub> )(CH <sub>2</sub> N(C <sub>2</sub> H <sub>5</sub> ) <sub>2</sub> )(C <sub>2</sub> H <sub>5</sub> )] <sub>3</sub>
23	(C <sub>2</sub> H <sub>5</sub> )( <sup>t</sup> C <sub>4</sub> H <sub>9</sub> SCH <sub>2</sub> )CCH <sub>2</sub> O	54	In[OC(CH <sub>2</sub> OC <sub>2</sub> H <sub>5</sub> ) <sub>2</sub> (C <sub>2</sub> H <sub>5</sub> )] <sub>3</sub>
24	(C <sub>2</sub> H <sub>5</sub> )(C <sub>2</sub> H <sub>5</sub> SCH <sub>2</sub> )((C <sub>2</sub> H <sub>5</sub> ) <sub>2</sub> NCH <sub>2</sub> )COH	55	In[OC(CH <sub>2</sub> SC <sub>2</sub> H <sub>5</sub> ) <sub>2</sub> (C <sub>2</sub> H <sub>5</sub> )] <sub>3</sub>
25	(C <sub>2</sub> H <sub>5</sub> )( <sup>i</sup> C <sub>3</sub> H <sub>7</sub> SCH <sub>2</sub> )((C <sub>2</sub> H <sub>5</sub> ) <sub>2</sub> NCH <sub>2</sub> )COH	56	In[OC(CH <sub>2</sub> S <sup>i</sup> C <sub>3</sub> H <sub>7</sub> ) <sub>2</sub> (C <sub>2</sub> H <sub>5</sub> )] <sub>3</sub>
26	(C <sub>2</sub> H <sub>5</sub> )( <sup>n</sup> C <sub>4</sub> H <sub>9</sub> SCH <sub>2</sub> )((C <sub>2</sub> H <sub>5</sub> ) <sub>2</sub> NCH <sub>2</sub> )COH	57	In[OC(CH <sub>2</sub> S <sup>n</sup> C <sub>4</sub> H <sub>9</sub> ) <sub>2</sub> (C <sub>2</sub> H <sub>5</sub> )] <sub>3</sub>
27	(C <sub>2</sub> H <sub>5</sub> )( <sup>t</sup> C <sub>4</sub> H <sub>9</sub> SCH <sub>2</sub> )((C <sub>2</sub> H <sub>5</sub> ) <sub>2</sub> NCH <sub>2</sub> )COH	58	In[OC(CH <sub>2</sub> S <sup>t</sup> C <sub>4</sub> H <sub>9</sub> ) <sub>2</sub> (C <sub>2</sub> H <sub>5</sub> )] <sub>3</sub>
28	KO <sup>t</sup> Bu	59	In[OC(CH <sub>2</sub> SC <sub>2</sub> H <sub>5</sub> )(CH <sub>2</sub> N(C <sub>2</sub> H <sub>5</sub> ) <sub>2</sub> )(C <sub>2</sub> H <sub>5</sub> )] <sub>3</sub>
29	Ga(O <sup>t</sup> Bu) <sub>3</sub>	60	In[OC(CH <sub>2</sub> S <sup>i</sup> C <sub>3</sub> H <sub>7</sub> )(CH <sub>2</sub> N(C <sub>2</sub> H <sub>5</sub> ) <sub>2</sub> )(C <sub>2</sub> H <sub>5</sub> )] <sub>3</sub>
30	Li[N(SiMe <sub>3</sub> ) <sub>2</sub> ]	61	In[OC(CH <sub>2</sub> S <sup>n</sup> C <sub>4</sub> H <sub>9</sub> )(CH <sub>2</sub> N(C <sub>2</sub> H <sub>5</sub> ) <sub>2</sub> )(C <sub>2</sub> H <sub>5</sub> )] <sub>3</sub>
31	In[N(SiMe <sub>3</sub> ) <sub>2</sub> ] <sub>3</sub>	62	In[OC(CH <sub>2</sub> S <sup>t</sup> C <sub>4</sub> H <sub>9</sub> )(CH <sub>2</sub> N(C <sub>2</sub> H <sub>5</sub> ) <sub>2</sub> )(C <sub>2</sub> H <sub>5</sub> )] <sub>3</sub>

# TABLE OF CONTENTS

---

<b>1</b>	<b>Introduction</b> .....	13
1.1	Alkoxides – General Remarks .....	13
1.2	Alkoxide Synthesis .....	16
1.2.1	Direct Synthesis .....	16
1.2.2	Reactions with Metal Halides .....	17
1.2.3	Reactions with Metal Amides .....	19
1.2.4	Alcohol Interchange Reactions (Alcoholysis) .....	20
1.2.5	Reactions with Metal Hydrides or Alkyls .....	21
1.2.6	Transesterification Reactions .....	22
1.2.7	Reactions with Hydroxides and Oxides .....	23
1.3	$\beta$ -donor-functionalised Alkoxides .....	24
1.4	Applications of Metal Alkoxides .....	25
1.4.1	Chemical Vapour Deposition .....	25
1.4.2	Sol-Gel Process .....	30
1.4.3	Metal Alkoxides in Catalysis .....	32
<b>2</b>	<b>Motivation and Research Goals</b> .....	35
<b>3</b>	<b>Results and Discussion</b> .....	37
3.1	Ligand Synthesis .....	37
3.2	Alkoxide Synthesis .....	44
3.3	NMR Studies .....	46
3.4	Single Crystal XRD .....	55
3.5	Thermal Properties .....	57
3.6	Low-Pressure CVD .....	60
<b>4</b>	<b>Summary</b> .....	64
<b>5</b>	<b>Experimental</b> .....	65
5.1	General Methods and Materials .....	65
5.2	Analytical Techniques .....	65
5.3	Ligand Syntheses .....	66
5.4	Alkoxide Syntheses .....	85
	List of References .....	106
	List of Figures, Schemes and Tables .....	113
	List of Compounds .....	115



# 1 INTRODUCTION

---

The development of new materials has become one of the most prominent fields of interest in modern science due to their broad range of applications. Novel materials, including specific morphologies of known substances and new compositions, are paving their way to simple applications for everyday needs as well as sophisticated use in niche applications. Generally, materials show a specific set of properties, such as hardness, photo- or electroluminescence, conductivity, catalytic activity, etc. predominately due to their chemical composition, as well as their micro- and macrostructure. The ‘molecule to material’ approach is a well-established process to obtain diverse materials including coatings and thin films, nanoparticles and –wires and advanced ceramics.<sup>[1]</sup> Among suitable precursor classes, metal alkoxides are promising candidates for the synthesis of high quality oxides.<sup>[2-5]</sup> For instance, titania and silica particles are nowadays produced by the ton for cosmetics and other applications using alkoxide precursors.<sup>[6, 7]</sup>

## 1.1 Alkoxides – General Remarks

---

Alkoxides are defined by IUPAC as substances RO-M, in which the organic rest R is saturated at the site of attachment to the oxygen atom and M is a metal or another cationic species.<sup>[8]</sup> This work will only focus on metal alkoxides.<sup>a</sup> Due to the relatively low electronegativity of the metal centres, alkoxides can be readily attacked by nucleophiles leading to a high tendency to hydrolysis.<sup>[9]</sup> Since most steps in industry require stable precursors with a controlled reaction behaviour, which additionally can be handled safely and are reproducible without tedious precautions, the modification of metal alkoxides to lower their reactivity has become an important field of research during the last decades.<sup>[10]</sup>

---

<sup>a</sup> In the following, the term *alkoxide* will further be used for metal alkoxides.

Lowering the reactivity of metal alkoxides can be achieved via two general routes: (i) variation of the electron density around the metal centre via inductive effects or (ii) via coordinative saturation of the metal using ligands with high steric demand. The latter is based on the fact that most metals exhibit coordination numbers that are higher than their valence state, thus trying to saturate their coordination sphere by hypervalent coordination or by oligomerisation via alkoxo-bridges (see figures 1 and 2).<sup>[11]</sup> The trend to oligomerisation and formation of hypervalent complexes generally increases with the ionic radius and the Lewis-acidity of the metal centre and decreases with increasing size of the alkoxo-ligands.<sup>[12]</sup> For instance, branching in the  $\alpha$ -position of the alkoxo ligands has a major effect on the oligomerisation tendency, which is shown for aluminium in figure 1.<sup>[13-15]</sup> Moreover, the electron donating character of specific solvents has to be taken into account since solvents such as ethers, amines or alcohols often coordinate to metal centres to saturate their coordination sphere.

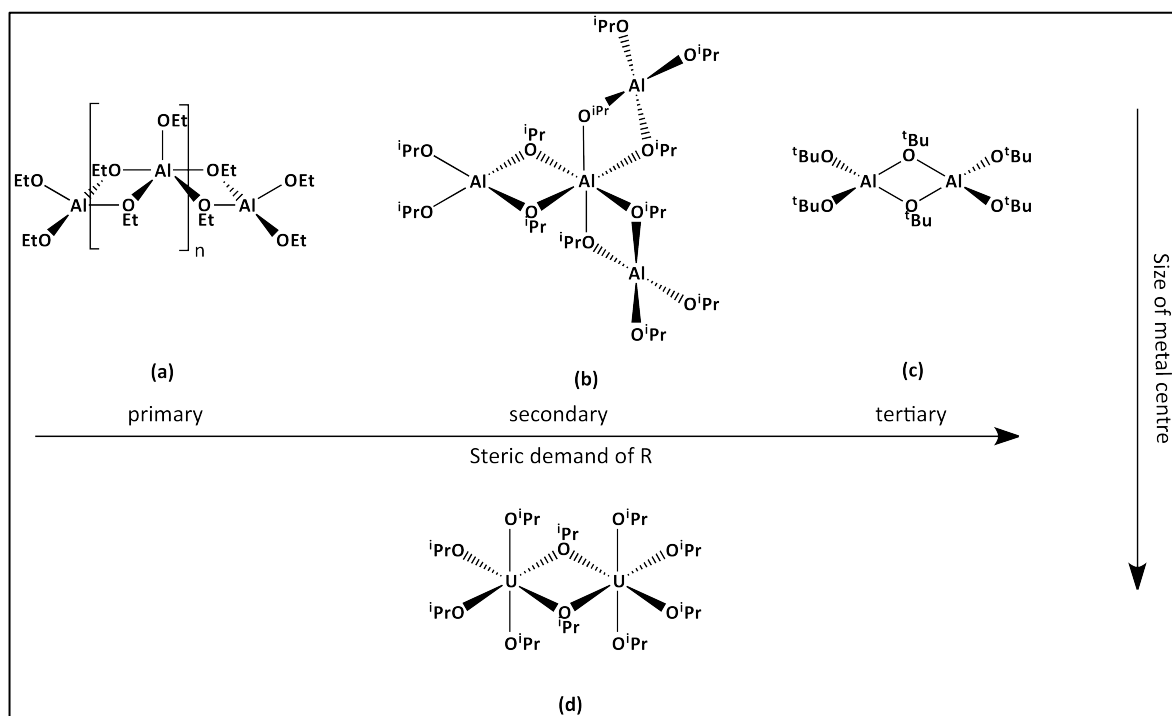

Figure 1: Structures of: (a)  $[\text{Al}(\text{OEt})_3]_n$ , (b)  $[\text{Al}(\text{O}^i\text{Pr})_3]_4$ , (c)  $[\text{Al}(\text{O}^t\text{Bu})_3]_2$  and (d)  $[\text{U}(\text{O}^i\text{Pr})_5]_2$ .<sup>[12]</sup>

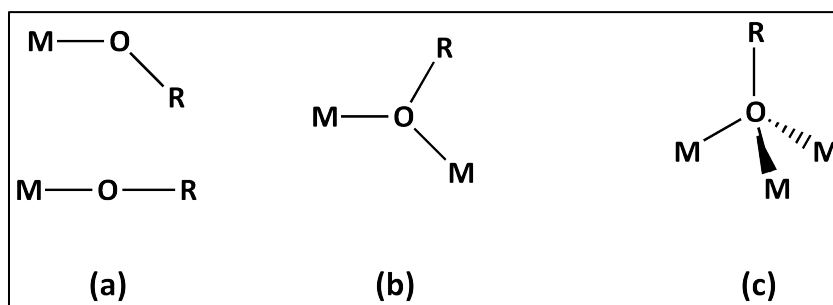

Figure 2: Conformations of alkoxo groups: (a) terminal, (b)  $\mu_2$ -bridging, (c)  $\mu_3$ -bridging.<sup>[11]</sup>

Most homoleptic metal alkoxide structures can be described with the structural elements shown in figure 2. For terminal alkoxo-groups arrangement (a) with a MOR angle of  $< 170^\circ$  is the dominant feature with the linear alignment only occurring in rare cases due to steric factors.  $\mu_2$ -bridging positions (b) regularly adopt a trigonal planar conformation, although pyramidal alignments have also been reported.<sup>[11]</sup> The  $\mu_3$ -bridging conformation (c) is often encountered in the case of very oxophilic metals exhibiting trigonal pyramidal arrangement.

Another intriguing feature of metal alkoxides is the metal-oxygen bond polarity. Judging from differences in electronegativity varying from approx. 2.6 for alkali metals to 2.0 for d-group metals, ionic characteristics of the M-O bond is to be expected. However, most alkoxides with lower degree of oligomerisation (non polymeric) are soluble in common organic solvents and show rather high volatility indicating covalent bonding. Multiple effects can explain these surprising features:<sup>[12]</sup>

- Inductive effects of the alkyl substituent at the oxygen atom lowering its electron pulling character (increasing effect with increased branching at the  $C_{\alpha}$ -position)
- $\pi$ -bonding between filled p-orbitals at oxygen and vacant d-orbitals at the transition metal centre.
- Formation of alkoxo-bridged oligomers.

## 1.2 Alkoxide Synthesis

Over the past decades several routes have been established to achieve alkoxide synthesis of almost every transition metal, main and even f-group element. However, the choice of the appropriate route is strongly dependent on the alcohol and the metal centre.

### 1.2.1 Direct Synthesis

Direct synthesis represents the easiest of all synthesis strategies by reacting an electropositive elemental metal with the alcohol yielding the metal alkoxide and hydrogen (see scheme 1).

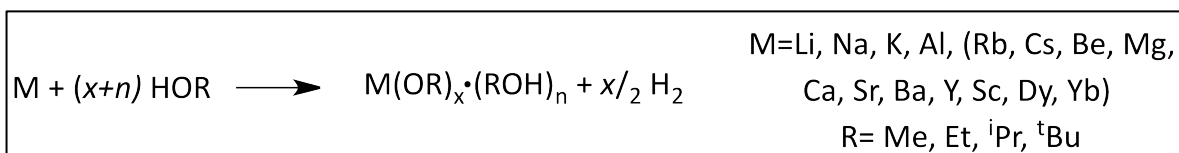

Scheme 1: Direct synthesis for the formation of alkoxides.

Although this reaction is usually used to synthesise alkali metal alkoxides as precursors for metathesis reactions<sup>[16]</sup> (*vide infra*), it has also been applied to other electropositive metals as described in scheme 1. Depending on the size of the metal and the degree of oligomerisation, varying amounts of alcoholate species and alcohols are coordinated to saturate the coordinative demand of the central atom.

Especially for highly reactive metals and rather acidic alcohols, this reaction works quantitatively without major drawbacks; however, catalysts such as I<sub>2</sub> or HgCl<sub>2</sub> are sometimes needed if bulkier alcohols or less reactive metals (Al, Mg, Be) are used.<sup>[13]</sup> Earth alkaline metals generally yield polymeric, non-volatile compounds with varying composition when directly reacted with sterically non-demanding alcohols such as methanol or ethanol. Soluble alkoxide derivatives of heavier earth alkaline metals (e.g. Ca, Sr, Ba) can be obtained using sterically demanding alcohols.<sup>[12]</sup>

## 1.2.2 Reactions with Metal Halides

Synthesis of metal alkoxides based on metal halides – generally chlorides – is a very versatile route. There are three different well-established approaches using metal halides as starting materials, which are shown in scheme 2, 3 and 4, respectively.

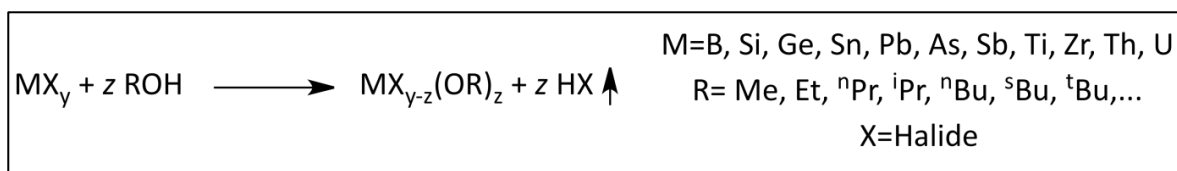

Scheme 2: Reaction of halide with alcohol.

The direct reaction of metal halides with alcohols usually proceeds to completion ( $y=z$ ) for more electronegative elements like boron or silicon. For more electropositive metals (e.g. Ti, Zr or Th), however, mixed alkoxo-halide or just solvate species have been isolated.<sup>[13, 17, 18]</sup> Furthermore, the evolution of HCl can cause side reactions – especially with tertiary alcohols. The sterically demanding tertiary alcohols can undergo elimination reactions in acidic milieu or form alkylhalides and water via substitution reactions, which subsequently leads to hydrolysis of the formed alkoxo species.<sup>[19]</sup>

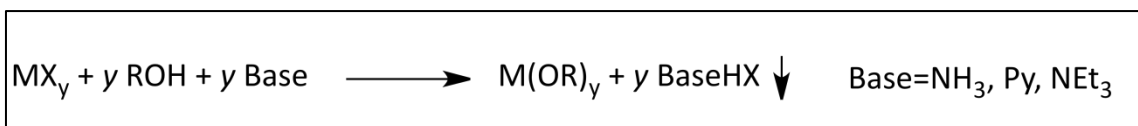

Scheme 3: Halide substitution in presence of a base.

Adding a base such as ammonia, pyridine or triethylamine to the reaction mixture can often circumvent the problems involving the evolution of HCl gas. During the reaction, the base deprotonates the alcohol. The formed alcoholate subsequently attacks the metal centre resulting in a nucleophilic substitution. In this process the metal alkoxide and a halide anion is formed, which subsequently generates a precipitating salt with the protonated base (see scheme 4).<sup>[12]</sup>

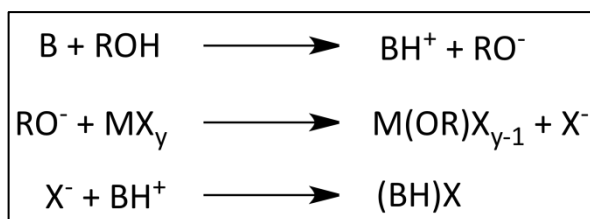

Scheme 4: Mechanism of base-assisted halide substitution.

The third route involving metal halides is the so-called transmetallation reaction, which is also referred to as salt elimination or metathesis reaction. This procedure uses an alkali metal alkoxide – usually Li, Na or K – to react with the metal halides forming alkali metal halide precipitates, which is shown in scheme 5.

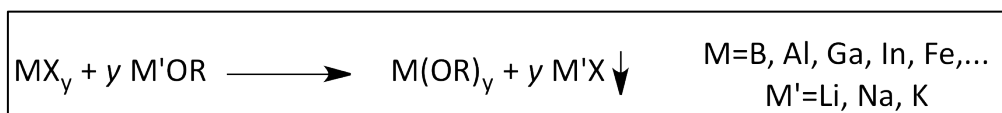

Scheme 5: Metathesis reaction.

This synthetic route has the advantage of being applicable to a wide range of different metals (and metalloids) and generally proceeds to completion for most sterically non-demanding organic groups owing to the thermodynamically favoured stability of alkali metal halides (gain of lattice energy). The reactions are usually carried out in hydrocarbons (benzene, toluene) or ethers, leading to insoluble salt precipitation and thus further shifting of the equilibrium towards the products.<sup>[12, 20-22]</sup>

More Lewis-acidic metals can exhibit further hypervalent coordination of the alkoxy-group bearing metal centre even if the substitution reaction was complete.<sup>[16]</sup> As a consequence, anionic complexes are formed via Lewis acid-base interaction and the alkali metal retains as a counter-cation. The probability of retention of both halide and counter-ion strongly depends on the steric demand of the alcoholate groups as well as the size of the halide and alkali metal, but also on the acidity of the metal centre. Generally, bulky groups sterically minimise the tendency for retention while smaller halides and alkali metals (Li) are carried on easier than their bigger analogues.<sup>[23]</sup> On the other hand, this facile retention or the use of more than stoichiometric amounts of alkali metal alkoxides is a possibility of synthesising heterometallic alkoxides as precursors for e.g. mixed-metal oxides.<sup>[24-27]</sup>

### 1.2.3 Reactions with Metal Amides

Synthesis starting from metal (dialkyl-)amides was introduced as a possibility to produce uranium(IV)alkoxides in 1964,<sup>[28]</sup> but has quickly become a very popular synthesis route. Readily accessible starting materials by metathesis reaction using alkali metal amides,<sup>[29]</sup> the easy substitution by alcoholate groups (good leaving group character) and the volatility of the resulting amines (depending on their functionalisation) are some reasons why this powerful technique is employed.

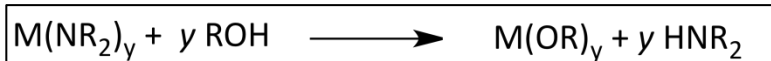

Scheme 6: Alcoholysis of metal amides.

Although a vast number of various amides of almost every main group and transition metal is reported up to date,<sup>[30]</sup> this type of reaction is mainly used for metals with higher affinity to oxygen rather than nitrogen or if traces of e.g. halides would affect further reactions. Especially hexamethyldisilazane (HMDS) and other trimethylsilyl containing amines have gained considerable attention. Their generally low molecular weight makes them easy to purify and the possible  $\beta$ -hydrogen elimination of other amines has not been reported for HMDS derivatives.<sup>[12, 16, 31]</sup> Furthermore, especially the bulky HMDS containing amides are sterically very well shielded and are forming mostly monomeric alkoxides, keeping acidic metal centres, which undergo easy alcoholysis.<sup>[30, 32, 33]</sup> The steric shielding and electronic properties of silylamides (increased M-N bond strength due to a unhybridised p-orbital at the nitrogen atom and electron-delocalisation between metal d-orbitals and the latter) also provide increased oxidative, thermal or photochemical stability.<sup>[34]</sup>

Another point in favour of the use of metal amide precursors is the selectivity of the alcoholysis reaction. Starting from metal halides, it is possible to achieve heteroleptic complexes bearing amides and halides both, which undergo stoichiometric and selective alcoholysis with the amides only. These compounds can further react in metathesis and alcoholysis reactions resulting in heteroleptic alkoxides (see scheme 7 for an example).<sup>[35-37]</sup>

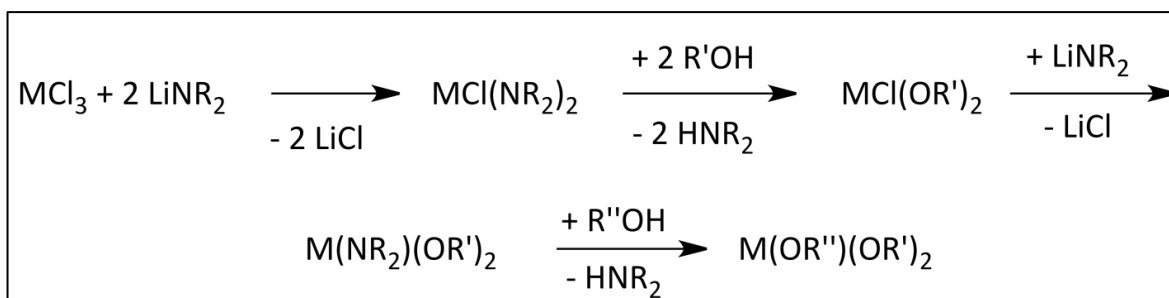

Scheme 7: Example for the formation of heteroleptic alkoxides using amide intermediates.

### 1.2.4 Alcohol Interchange Reactions (Alcoholysis)

Alcohol interchange reactions are widely used reactions for the synthesis of homo- and heteroleptic alkoxides.<sup>[20, 22, 38, 39]</sup> The rate of the alcohol/alkoxide exchange strongly depends on steric demand and acidity of the alcohol and the alkoxy ligand, respectively.

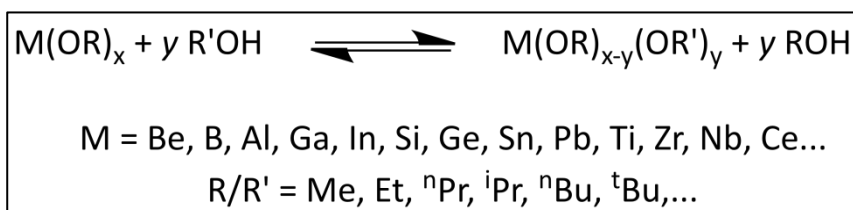

Scheme 8: Alcohol interchange reactions.

In general, the reaction rate of alcoholysis reactions decreases from primary to secondary to tertiary alcoholate-ligands (OR in scheme 8), since tertiary alcohols on one hand make it sterically hard to attack the metal centre and on the other hand are more acidic due to inductive effects.<sup>[12, 19, 40]</sup> Alcohol exchange reactions have been further shown to be equilibrium reactions<sup>[41]</sup>, which has been demonstrated later by NMR experiments showing only one signal for  $\text{Ti}(\text{OEt})_4$  in EtOH (fast exchange),<sup>[12]</sup> but two signals for  $\text{Ti}(\text{O}^t\text{Bu})_4$  in  $^t\text{BuOH}$ <sup>[42]</sup> (slow exchange).

With that in mind, ligand exchange is often not complete especially when starting from tertiary alkoxides yielding mixed alkoxo species. Nevertheless, the equilibrium can be shifted to complete substitution if the exchanged alcohol is removed from the reaction mixture by evaporation or (azeotropic) distillation. Moreover, chelating effects of the alcohol should be



considered due to their impact on reaction rates and equilibrium state. Multidentate ligands, such as  $\beta$ -diketones,  $\beta$ -ketoesters, etc. form stronger bonds to the metal centres than simple alcohols and hence are scarcely exchanged again once bonded.

### 1.2.5 Reactions with Metal Hydrides or Alkyls

The synthesis strategy using hydrides as starting materials is one of the lesser used reaction routes to homoleptic metal alkoxides ( $M(OR)_x$ ), but is used when mixed hydride alkoxide species ( $MH_y(OR)_x$ ) are required, since hydrogenation of other mixed species (e.g. chloroalkoxides) is not always possible.<sup>[37, 43, 44]</sup>

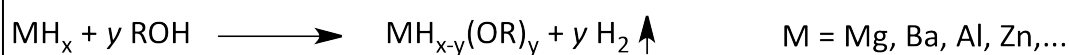

Scheme 9: Alkoxide synthesis using metal hydrides.

The advantage of the hydride route lies within the high reactivity of metal hydrides and the formation of gaseous side-products. Nevertheless, the evolution of hydrogen might lead to side reactions like hydrogenation of double bonds or redox reactions.

Starting from metal alkyls on the other hand is a commonly used route especially for mixed alkyl alkoxo compounds, but also homoleptic alkoxo species.<sup>[45-61]</sup> Since most metal alkyls show rather high volatility (for  $R=Me, Et$ ) they are widely used precursors for industrial CVD processes making them readily available (e.g.  $GaMe_3, InMe_3$ ).

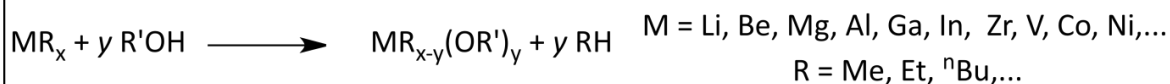

Scheme 10: Reaction of an alcohol with metal alkyls.

The carbanionic alkyl ligands are readily protolysed by alcohols leading to stoichiometric substitution due to the polarity of the M-C bond. The simplest example of this reaction type is the formation of Li alkoxides by reaction of alcohols with  $^nBuLi$ . Similar to the hydride or amide route the reaction with alkyls produces volatile side products, which are easily

removed, allowing excellent yields for the substitutions.<sup>[12]</sup> However, complete substitution is not always achieved. For instance, using trimethyl gallium or indium and reacting them with three equivalents of alcohol usually leads to disubstituted monomethyl alkoxides.<sup>[62]</sup>

### 1.2.6 Transesterification Reactions

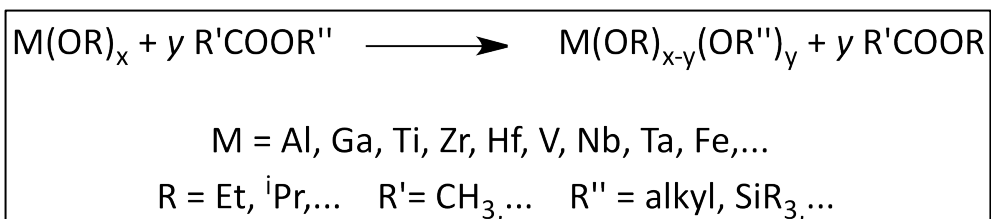

Scheme 11: Transesterification reaction for alkoxide synthesis.

Transesterification reactions were first applied to aluminium alkoxides and later extended to other (transition) metals. Although the reaction is in principle very similar to alcohol interchange reactions, transesterification bears some advantages when compared with the latter under specific circumstances.<sup>[25, 39]</sup> One point in favour is that steric effects do not influence the reaction rate as much in transesterification as it does for alcohol interchange. Thus, tertiary alcoxides may be synthesised easier. Furthermore, the common side products ethyl- and isopropyl acetate (when starting from ethoxy or isopropoxy alkoxide species and acetic acid esters) are easily evaporated or removed as an azeotrope in cyclohexane.<sup>[12]</sup> The reaction mechanism is not fully understood yet, but the fact that the steric demand seems to play a minor role, indicates a mechanism involving coordination of the carbonyl oxygen (see scheme 12). This scenario would also be in accordance with early IR measurements by Lappert *et al.*<sup>[63, 64]</sup> In the first step of the proposed mechanism, the carbonyl oxygen attacks the metal centre and one alkoxy group is transferred. This leads to dative bonding of the generated ether. Due to the rather weak bonding, rotation around the alkoxy bond is possible leading to coordination of the second ether and subsequently to the formation of the new ester and alkoxide.

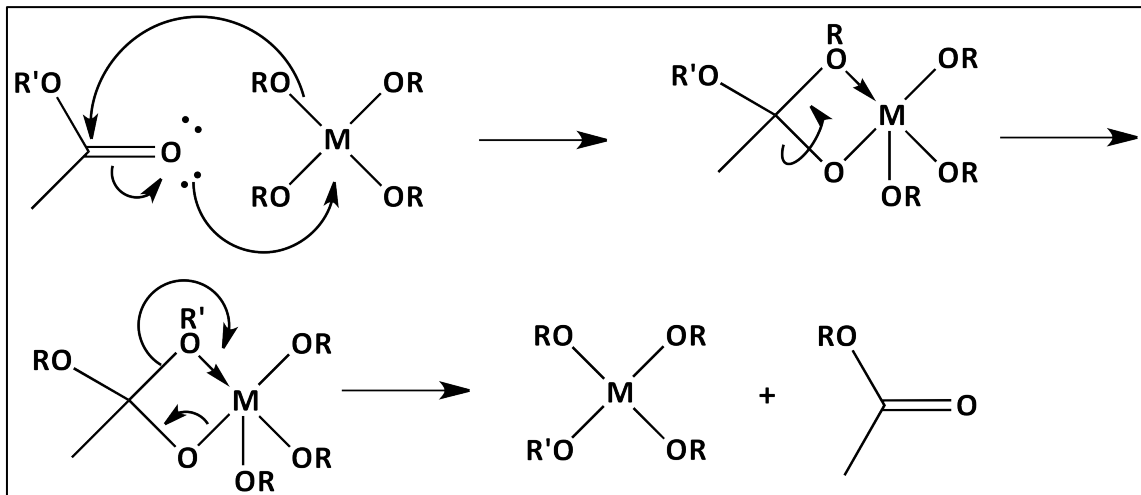
Scheme 12: Proposed mechanism for transesterification reactions.<sup>[12]</sup>

### 1.2.7 Reactions with Hydroxides and Oxides

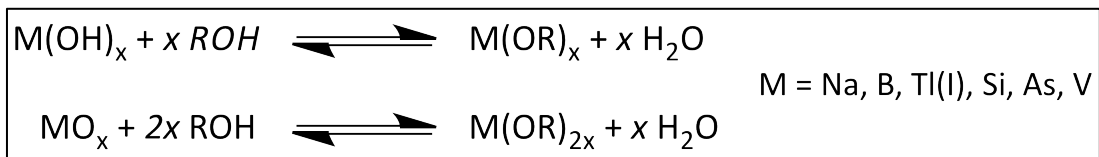

Scheme 13: Reactions of hydroxides and oxides to form alkoxides.

The preparation of metal and metalloid alkoxides from hydroxides and oxides only applies to a few s- and p-elements, due to the higher thermodynamical stability of most metal-oxides compared to the corresponding alkoxides. The main reason is the corresponding lattice energy of the oxides and therefore this technique is rarely used. So far, synthesis of alkoxides via this route has only been achieved for Na, B, Tl(I), Si, Ge, Sn, Pb, As and V because of the oxyacidic or acid anhydride behaviour of the hydroxides or oxides, respectively.<sup>[12, 65]</sup> Owing to this characteristic feature, these compounds can form the esters (alkoxides) and water when reacted with alcohols (see scheme 13). Completion of the reaction and an accomplished shift of the equilibrium towards the products requires constant removal of water, which is generally achieved by azeotropic distillation with benzene, toluene or xylene.

### 1.3 $\beta$ -donor-functionalised Alkoxides

$\beta$ -donor-functionalised alkoxides as improved precursors for CVD applications were first introduced in 1989 by Horowitz *et al.*<sup>[66]</sup> Since most CVD experiments require precursors with high volatility amongst other requirements (*vide infra*), it is necessary to achieve synthesis of low-molecular species.<sup>[67]</sup> As described in section 1.1, alkoxides tend to formation of hypervalent compounds by oligomerisation, thus dramatically increasing the molecular weight leading to reduced volatility. Bulky ligands may reduce oligomerisation tendencies, but simultaneously increase the molecular weight of the alkoxide species. Therefore, this strategy is not optimal to achieve high volatility. Donor-functionalisation makes it possible to lower the degree of oligomerisation by coordinative saturation and simultaneous shielding of the metal centre. Nevertheless, according to literature most of the homoleptic alkoxides using sterically compact donor-functionalised alcohols are non-volatile, but soluble polymers making them useful for sol-gel processes, but not for CVD applications.<sup>[11]</sup> This fact has led to a popular approach of using combinatorial effects of steric demand (secondary and tertiary alcohols and/or bulky organic rests at donor) and donor capabilities.<sup>[68]</sup>

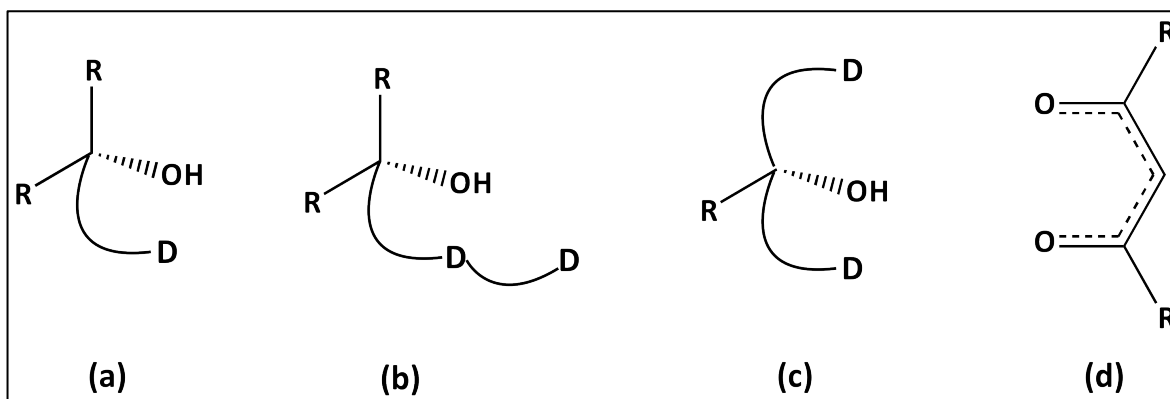

Figure 3: Various types of donor-functionalisation: (a) bidentate, (b,c) tridentate, (d)  $\beta$ -diketonate, D = donor.

Figure 3 illustrates a few different approaches to achieve appropriate donor-functionalisation including donor groups in  $\alpha$ - or  $\beta$ -position, bi- or tri dentate alcohols, or the use of  $\beta$ -diketonates.<sup>[15, 69]</sup>  $\beta$ -diketonates (acetylacetonate (acac), 2,2,6,6-tetramethylheptan-3,5-dione (thd),  $\beta$ -ketoesters, malonic esters, etc.) or fluorinated

derivatives thereof have frequently been used due to their simple syntheses and moderate volatilities. Nonetheless, donor-functionalised alcohols have recently gained increased attention since  $\beta$ -diketonates can lead to carbon contamination of the produced materials when used as CVD precursors without additional oxidising agents;<sup>[11]</sup> however, the use of  $\beta$ -diketonates in sol-gel processes or ALD-processes is still common practice due to their slower hydrolysis rates resulting from coordinative saturation via chelating effects.<sup>[70-76]</sup>

The most commonly used donors are (dialkyl-) amines<sup>[77-83]</sup> and ethers,<sup>[22, 36, 53, 57, 58, 60, 84, 85]</sup> but there are also very rare reports of phosphines<sup>[86, 87]</sup> and thioethers.<sup>[88]</sup> Amines are a widely used class of donor molecules (e.g. pyridine, ethylenediamine) known to coordinate to most metals as a  $\sigma$ -donor. Likewise, amines are amongst the most used functional groups in donor-functionalised alcohols. Ethers also are often used due to the oxygen affinity of most metals and the resulting strong bonding between donor and metal centre, which is also known for ether-solvents such as diethylether or THF.<sup>[89, 90]</sup>

## 1.4 Applications of Metal Alkoxides

---

Metal alkoxides are widely used substances for various processes due to their unique, well defined and tuneable features. In most cases they are simply used as precursors or synthons to achieve synthesis of oxide materials or other organic species with specific properties (e.g. morphology, conductivity, etc.), which cannot be achieved as easily by other routes. With this in mind, metal alkoxides are most often used in three different areas, namely as (i) precursors in chemical vapour deposition (CVD) and (ii) sol-gel processes, as well as (iii) catalysts in synthetic chemistry.

### 1.4.1 Chemical Vapour Deposition

Chemical vapour deposition is defined as a process involving chemical reactions and/or dissociation of gaseous reagents in an 'activated' environment (usually heated, irradiated or supported by a plasma) leading to the deposition of solid materials. The process includes

homogeneous gas-phase reactions and/or heterogenic reactions on or near the surface of a heated substrate.<sup>[91]</sup> There are numerous variations of the activation process and the generation of the gaseous reagents, e.g. low-pressure CVD (LPCVD),<sup>[56, 92-94]</sup> plasma-assisted and plasma enhanced CVD (PACVD/PECVD),<sup>[95-97]</sup> aerosol-assisted CVD (AACVD)<sup>[37, 84, 98, 99]</sup> or photon-assisted CVD.<sup>[100-102]</sup> The different techniques are all bearing their specific advantages for certain purposes.

CVD processes have a few distinct advantages compared to other deposition methods, such as physical vapour deposition (PVD) or sol-gel processing. CVD is widely used for thin film deposition in the (micro-)electronic sector (e.g. Si, Ge, III-V and II-VI semiconductors, SiO<sub>2</sub>, W, Pt,...) and the area of protective or hard-coatings (e.g. TiN, SiC). In addition, it is a common technique for the production of 1D nanostructures such as nanowires, -tubes, -rods or -belts. The advantages of this process include the production of both dense and porous materials in very high purities under solvent-free conditions and non-line-of-sight deposition meaning that complex shaped substrates can be uniformly covered. Typically, CVD uses comparably simple apparatuses and vacuum systems, as well as low deposition temperatures leading to lower costs. In addition, CVD has a rather high throughput and allows easy control of deposition rates. Under specific circumstances crystal structure and orientation (e.g. epitaxial growth), as well as the surface morphology can be tailored to achieve optimal results. Furthermore, a wide range of precursor species can be used in CVD, such as carbonyls, metal halides, organometallics, etc. Disadvantages are often related to the physicochemical properties of the source material, such as a pyrophoric, toxic or corrosive nature. Moreover, the control of stoichiometry can be an issue especially when multi-source precursors are used. The non-stoichiometry can be due to differences in vapour pressure of the precursors leading to different deposition rates. Fortunately, this problem can be targeted and overcome by single-source precursors.

New and advanced precursors are desired since many current issues in CVD processes are related to the use of suboptimal and hazardous precursors. Potential precursor species have to meet many requirements to become a suitable alternative:<sup>[67, 91]</sup>

- Stability at room temperature
- High vapour pressure and preferably liquid or gaseous state of the precursor for steady precursor flow to the substrate
- Low vaporisation temperature
- Safe handling possibilities, i.e. non-toxic, non-corrosive, non-pyrophoric...
- Decomposition/chemical reaction at low temperatures yielding the desired product and volatile by-products in high purity
- Suitable deposition rates
- Preferably single-source precursor (one precursor that incorporates all elements for the final product), especially for multi-component systems
- Low costs and readily available on a large scale in good purity

The combination of all aforementioned requirements in one precursor is almost impossible and therefore compromises have to be made in precursor design. For example, fluorination of alkoxides usually leads to increased volatility compared to their non-fluorinated counterparts.<sup>[103-105]</sup> However, decomposition of these precursors can lead to fluorine incorporation,<sup>[80, 106]</sup> which alters the physicochemical properties of the resulting materials.<sup>[58]</sup>

Although the CVD process is very complex, it can be divided and described in a few fundamental steps, which are illustrated in figure 4:<sup>[107]</sup>

- (a) Formation of the gaseous reagents.
- (b) Vapour phase transport of the reactants into the reaction chamber.

Reaction in the gas phase forming intermediate species:

- (c') Homogeneous decomposition/reaction in the gas phase leading to solid particles, which are deposited on the substrate surface. Decomposition in the gas phase is not

desired due to the premature formation of particles and reduced mobility on the surface.

- (c) Diffusion or convection of the intermediates through the boundary layer to the substrate's surface. The boundary layer is the thin volume of gaseous species in proximity of the surface.
- (d) Absorption of the gaseous reactants onto the heated substrate leading to heterogenic reactions at the solid-gas interface forming the adsorbed reaction species and (volatile) by-products.
- (e) Diffusion of the adsorbed solid species on the surface leading to film growth and/or generation of crystallisation centres.
- (f) Desorption and diffusion/convection of by-products through the boundary layer.
- (g) Removal of unreacted precursor molecules and by-products from the reaction chamber.

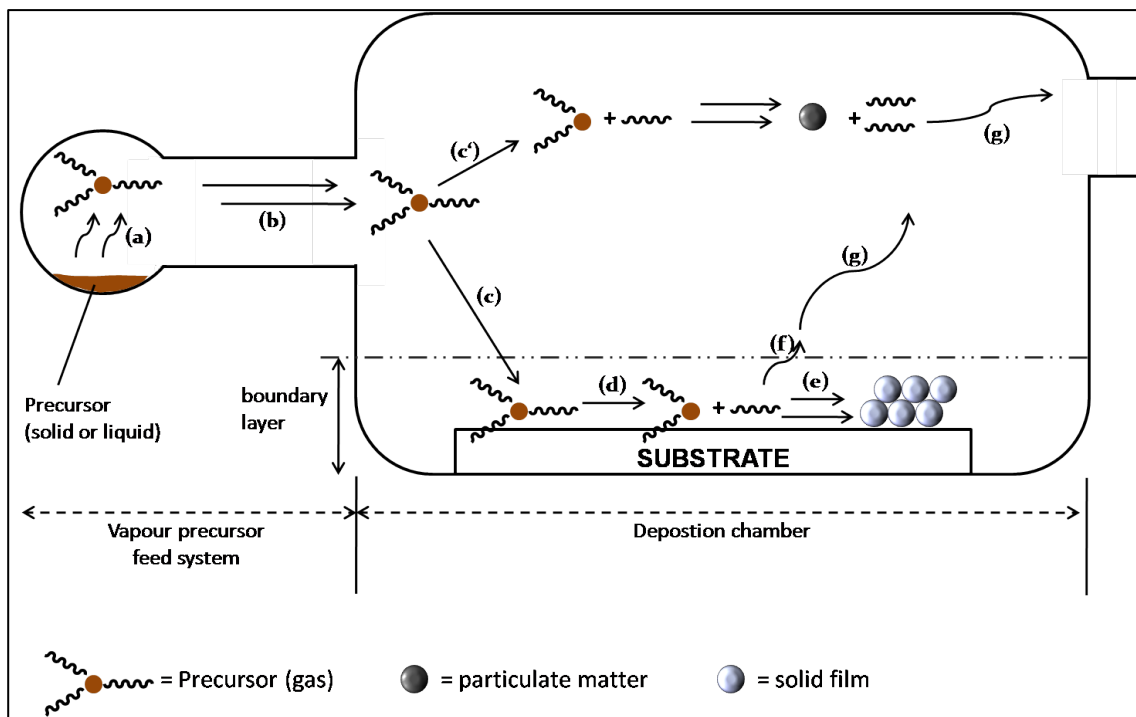
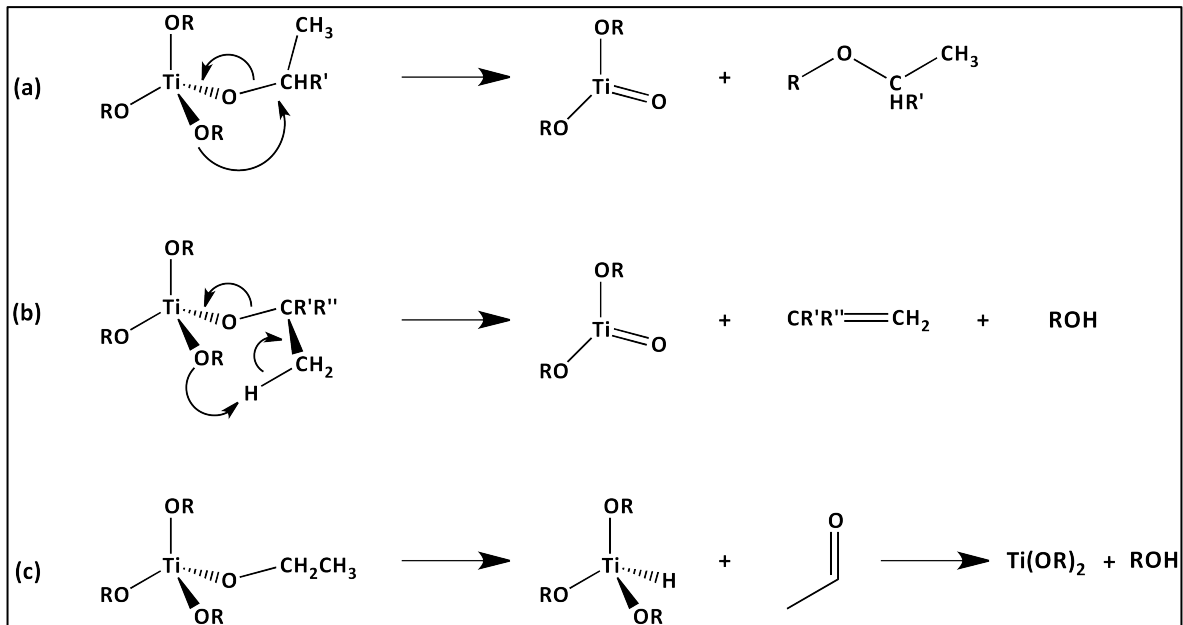

Figure 4: Fundamental steps of a CVD process.



The type of reaction/decomposition pathway can vary depending on the precursor(s) used and include pyrolysis, reduction (commonly with H<sub>2</sub>), oxidation (with O<sub>2</sub>, O<sub>3</sub>, etc.), disproportionation (using halides for deposition of metals), nitridation (with N<sub>2</sub>, NH<sub>3</sub>, etc.) and hydrolysis, just to name a few.<sup>[91]</sup> In regard to this thesis, only pyrolysis will be discussed in detail. Although the mechanism of pyrolysis in CVD reactors has been studied by various techniques including MS,<sup>[108-110]</sup> FTIR,<sup>[111]</sup> IRRAS (Infrared reflection absorption spectroscopy),<sup>[112]</sup> Raman spectroscopy,<sup>[113]</sup> NMR spectroscopy<sup>[114]</sup> and has been simulated using DFT calculations,<sup>[113]</sup> opinions differ when it comes to the mechanism. Nevertheless, β-hydrogen elimination and homolysis are the most dominant choices for pyrolysis routes of metalorganyls such as GaEt<sub>3</sub>, Ga<sup>i</sup>Pr<sub>3</sub>, Ga<sup>t</sup>Bu<sub>3</sub> or GeEt<sub>4</sub>,<sup>[111, 113-115]</sup> but other routes, e.g. β-alkyl elimination for branched organyls<sup>[116]</sup> have been proposed. In comparison to the metal organyls, only very few reports have been published on the thermal decomposition of metal alkoxides. Tumas *et al.* and later Chiu *et al.* showed experimentally and via theoretical calculations that alkoxide anions in the gas phase mainly decompose via 1,2-eliminations.<sup>[117, 118]</sup> During this process a hydride or carbanionic species is generated which then deprotonates via an ion-molecule-complex transition state to form either hydrogen or methane and the corresponding enolate species. Nandi *et al.* proposed simple titanium alkoxides pyrolysis via intramolecular ether formation for compact alcohols and β-H elimination for sterically more demanding ones, as well as β-H transfer and carbonyl formation (see scheme 14).<sup>[119]</sup> Furthermore they claim that no Ti-O or O-R homolysis reaction occurs, since neither OR radicals nor R-R species could be found in NMR, GC or GC/MS measurements. MS data for the pyrolysis of tin tert.-butoxide also suggests a mechanism according to scheme 14(b).<sup>[120]</sup>



Scheme 14: Possible pyrolysis pathways for titanium-alkoxides: ether formation (a),  $\beta$ -hydride elimination (b) and  $\beta$ -hydride transfer (c).

## 1.4.2 Sol-Gel Process

The sol-gel process is a well-established technique for the production of diverse ceramic materials, such as coatings,<sup>[121-123]</sup> xero- and aerogels,<sup>[124-126]</sup> as well as particles.<sup>[127, 128]</sup> Since the process is considered as green chemistry (using mainly water and/or alcohols as solvents) and *chimie douce* (soft reaction conditions, e.g. temperature)<sup>[129]</sup> and due to the simplicity of the required equipment, the technique is the main alternative to CVD and PVD processes for coating applications. The alkoxide-based sol-gel process was first developed for the production of silica, but it soon extended to titania and other transition metal oxides based on various precursor species (e.g. acetates,  $\beta$ -diketonates, alkoxides, halides).<sup>[9]</sup> The standard alkoxide-based sol-gel process is a hydrolytic process involving three main reactions that lead to the formation of an oxide material, as depicted in scheme 15.

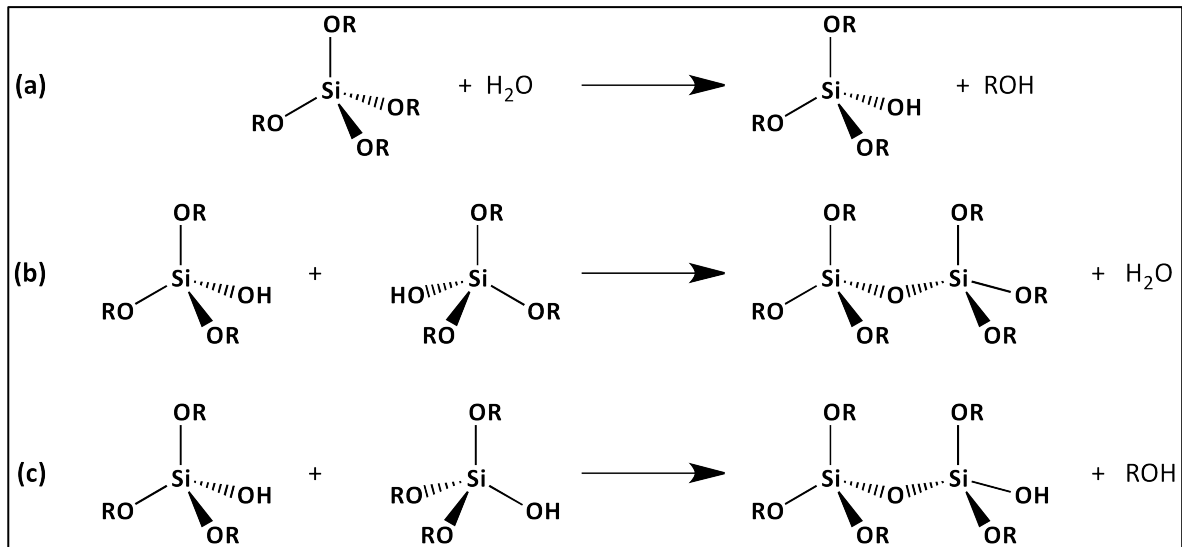

Scheme 15: Main reactions of the sol-gel process shown for Si precursors:  
(a) hydrolysis, (b) oxolation, (c) alkoxolation.

The first step in the process is a controlled hydrolysis (scheme 15(a)) of M-OR bonds to form hydroxy groups releasing the free alcohol. Subsequently, the hydroxy groups can then undergo condensation reactions either by oxolation (scheme 15(b)) or alkoxolation (scheme 15(c)) to form M-O-M bonds. A three dimensional network (oligo- or polymeric chains, particles,...) is build up after a continuation/repetition of such processes, which becomes insoluble at a certain extent or molecular weight forming a colloidal suspension, the so-called sol. A gel develops if the aforementioned processes continue to form polymeric chains and link the existing network. The gel is defined as a continuous, porous network through the whole sample, supporting the remaining liquid phase. The network can either be 'colloidal' exhibiting an agglomeration of dense particles or 'polymeric' when the substructure is indeed a polymeric chain.<sup>[130]</sup>

It is crucial to control the reaction rate during the process to achieve the desired products. Therefore, process parameters such as pH (the hydrolytic sol-gel process forming silica-based materials is both catalysed by acids and bases<sup>[9]</sup>) and temperature have to be monitored and an adequate precursor should be carefully chosen. For example, for dip-coating applications it is necessary to obtain a relatively long-lived sol, which is coated on the substrate before extended condensation takes place. Moreover, control of the hydrolysis rate is especially important when mixed-metal systems are desired or if metal

alkoxide precursors are applied. As mentioned before, metal alkoxides are in contrast to Si-alkoxides – Si exhibits lower electropositivity and generally has a coordination number equal to its oxidation state (+4) and no tendency to coordinative expansion – prone to nucleophilic attacks and therefore exhibit hydrolysis rates that are higher by several orders of magnitude when compared to silicon counterparts and thus have no need of catalysts. In addition, metal alkoxides, oxo- and oxide species lead to spontaneous precipitate formation upon addition of water rather than controlled gelation due to their tendency for hypervalent coordination.<sup>[131]</sup> These circumstances require the development of more stable, slower reacting alkoxides.

As mentioned before, the sol-gel process allows the synthesis of various materials. Adapting the reaction parameters, especially the pH value, and the precursor composition (possibility to achieve non-stoichiometric materials, ‘Lego’-principle of brick-by-brick assembly) leads to systematic formation of a type of product. Under basic conditions using Si-alkoxides for example, the reaction rate is highest at the most branched Si atoms due to its lower electron density (higher Lewis acidity), which leads to highly branched colloidal networks. On the other hand, low branched polymeric systems are formed under acidic conditions.<sup>[132]</sup> Besides influencing the type of material as well as its morphology,<sup>[133-135]</sup> due to its mild reaction conditions, the sol-gel process also allows for the synthesis of inorganic-organic hybrid materials by attaching hydrolytically stable groups to the precursor molecules.<sup>[136]</sup> These can be for example simple basic/acidic functionalities or polymerisable functional groups, leading to host-guest systems,<sup>[137, 138]</sup> possibilities of post-synthesis reactions/functionalisation or interpenetrating polymer networks.<sup>[139, 140]</sup>

### 1.4.3 Metal Alkoxides in Catalysis

Metal alkoxides catalysts in organic chemistry exploit features that one tries to suppress when using metal alkoxides as CVD or sol-gel precursors, namely the Lewis acidity of their metal centres (their electrophility) and the capability of ligand exchange reactions. Metal alkoxides are mostly applied as catalysts in the areas of ring opening polymerisation<sup>[141]</sup> of

epoxides, lactones, etc. or for oxidation and reduction processes.<sup>[142-144]</sup> In both areas, Zr-alkoxides seem to be favoured over other species due to their non-toxicity, easy accessibility, low price, good selectivity and activity. Other used alkoxides systems are often based on Zn, Ti, Hf or lanthanides.

To be applicable as a catalyst, alkoxides need to fulfil the following preliminaries:<sup>[142]</sup>

- Moderate Lewis acidity
- Fast ligand exchange / reaction of the alkoxy-ligands with proton-donating ligands

With these preliminaries in mind, alkali metals for example are not useable despite their fast ligand exchange, because of their low charge density and low coordination numbers. Aluminium alkoxides on the other hand do not seem very feasible, since ligand exchange is too slow when used in catalytical amounts.<sup>[142]</sup> In the catalytic cycle the alkoxides generally have the following purposes:<sup>[143]</sup>

- Bonding of both reactions partners, thus bringing them in close vicinity and often confining them in a certain molecular arrangement
- Activate the coordinated species due to changes in the electron density via charge transfer from/to the metal centres

In the Meerwein-Ponndorf-Verley reduction for example, the hydride transfer from an alcohol to a ketone/aldehyde is only made possible by the electron transfer from the ketone to the metal centre (making the carbonyl C more electrophilic) and from the metal to the alcohol (giving the hydrogen more hydride-character) and the arrangement in a six-membered transition state, which is depicted in scheme 16.

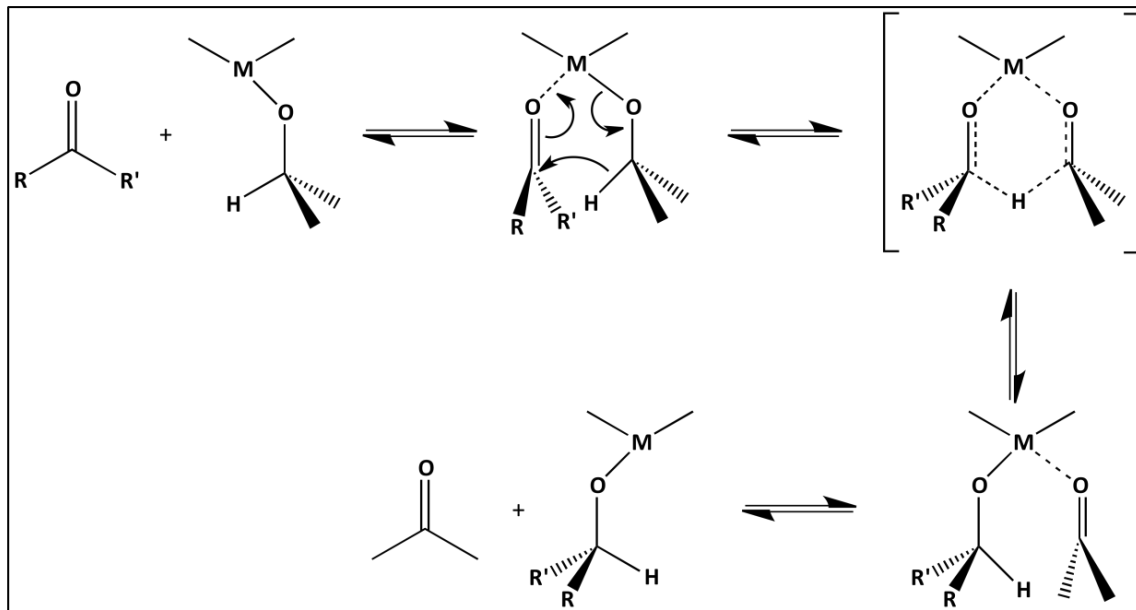

Scheme 16: Alkoxide mediated Meerwein-Ponndorf-Verley reduction reaction.

## 2 MOTIVATION AND RESEARCH GOALS

---

$\text{Ga}_2\text{O}_3$  and  $\text{In}_2\text{O}_3$  are very important wide bandgap semiconductor materials and are used in several areas of application.  $\beta\text{-Ga}_2\text{O}_3$  ( $E_g=4.9$  eV)<sup>[145]</sup> has been used as luminescent phosphors, UV-transparent conducting oxides layers and more recently in resistor-type gas sensors, due to its response to oxidising and reducing gases (such as CO, H<sub>2</sub>, CH<sub>4</sub>,...) at elevated temperatures.<sup>[146-149]</sup> Cubic  $\text{In}_2\text{O}_3$  ( $E_g=2.93$  eV)<sup>[150, 151]</sup> on the other hand is – in its Sn-doped form indium tin oxide (ITO) – the most prominent transparent conducting oxide (TCO) on the market. ITO is used in various devices and applications, such as LED and OLEDs, solar cells or electrochromic windows.<sup>[152-157]</sup> Despite the potential applications of both oxides, they suffer from some drawbacks in their production processes. Both materials are widely produced via sol-gel processes, sputtering, CVD, PVD, spray pyrolysis or thermal deposition, just to name a few possibilities.<sup>[93, 149, 158-163]</sup> However, many of these techniques suffer from inherent disadvantages including varying stoichiometry or defect concentration in the resulting materials, high energy consumption, low throughput, limitation of the substrate-size, variations in surface morphology and crystal phase, etc. Especially in CVD most drawbacks originate from the type of used precursor; therefore it is a necessity to develop new, stable and safe precursors, which lead to reproducible oxide materials with the desired physical and chemical properties.

This thesis was focused on the synthesis and characterisation of novel  $\beta$ -donor-functionalised group 13 alkoxides for applications in low-pressure CVD. The first aim was to synthesise new organic ligands that bear different donors bonded to the C <sub>$\beta$</sub> -position of the alcohol, in particular thioethers and amines, to gain information about the characteristics of different functionalities as donor sites. The alcohol species were limited to tertiary and secondary alcohols for direct comparison of the steric influence. Moreover, the organic groups attached to the potential donors (coordinating sites) were varied to investigate the inductive and steric effects on the donor-strength. Moreover, asymmetrically substituted alcohols bearing both amine and thioether functionalities should be synthesised to further

analyse the competitive donor capabilities. All ligands were thoroughly characterised by  $^1\text{H}$  and  $^{13}\text{C}$  NMR, FTIR and GC/MS.

These novel alcohol ligands should then be used to synthesise the corresponding gallium and indium alkoxides, respectively, using standard ligand exchange reactions. The alkoxides were characterised by  $^1\text{H}$  and  $^{13}\text{C}$  NMR as well as single crystal XRD if suitable crystals could be obtained. In addition, the thermal properties and thus the applicability as novel CVD-precursors should be investigated via TGA measurements.



## 3 RESULTS AND DISCUSSION

---

### 3.1 Ligand Synthesis

---

As mentioned before, this work focuses on the synthesis of alkoxides of secondary and tertiary alcohols with  $\beta$ -donor functionalisation. Most literature reports deal almost exclusively with the properties and applications of oxygen and nitrogen donors, such as ethers and amines. In this work, an extension of this approach is presented. The previously neglected thioether alcohol species have been targeted for such fundamental studies. For this purpose, novel ligand systems had to be synthesised and strategies to gain access to such unknown derivatives were developed. We aimed and achieved generalised synthesis strategies to gain access to the thioether alcohols in relatively high yields at low costs. Most of the synthesised secondary and tertiary alcohols as well as their intermediates are novel species, which have not been reported in literature, with only a few exceptions of compounds, which were merely described as by-products or potential compounds for specified applications. Such findings are already indices that the results presented here are opening up a new field for alkoxide synthesis and pave the way to exciting, new metalorganic compounds.

Mercaptans show higher acidic behaviour than their alcohol counterparts and therefore they can be readily used as nucleophilic reagents. In addition, the high reactivity of epoxide species has been exploited throughout the synthesis of the donor-functionalised alcohols. Figure 5 shows a general reaction scheme for the synthesis of the secondary alcohols containing thioether functionalities.

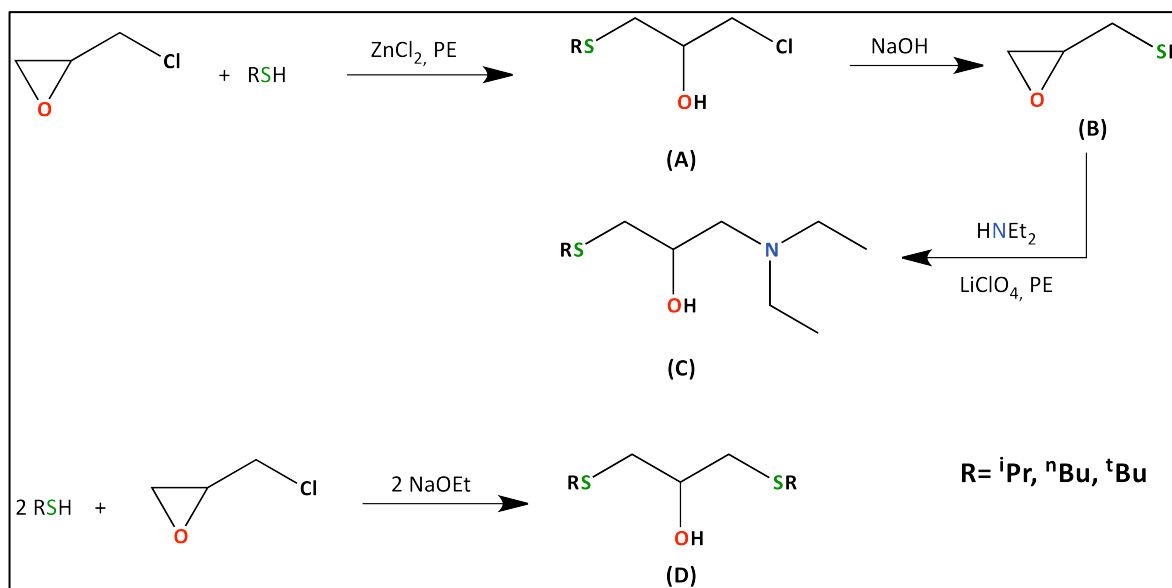

Figure 5: Synthesis approach for secondary alcohols.

The asymmetrically substituted alcohols (C) have been synthesised in a multi-step approach. In the first reaction stage, a ring opening of epichlorohydrin was achieved via nucleophilic attack of an alkylmercaptan in presence of catalytic amounts of  $\text{ZnCl}_2$ . This catalyst is known to promote the ring opening of epoxides under soft conditions to yield chlorohydrines (A).<sup>[164, 165]</sup> The compounds were formed in rather moderate to good yields (26-75 %) depending on the steric demand of the applied thiol. Notably, only the terminal adducts were isolated and no primary alcohols were found as indicated by NMR spectroscopy, which is mainly due to steric reasons. Thioether-functionalised epoxides (B) can be subsequently formed by elimination of HCl from the chlorohydrines under basic conditions. The obtained oxiranes can then be attacked by nucleophiles in an additional step to yield asymmetrically substituted alcohols. In the case of the applied diethylamine, a perchlorate catalyst (Li or Zn are reported to exhibit good activity)<sup>[165, 166]</sup> was used, which resulted in high yields of 80 to 93 %. It is noteworthy that (A), (B) and (C) have chiral centres and (D) are enantiomeric compounds. Since chirality did not matter for the purpose at hand, the isomers were not separated and simply purified via distillation. Detailed synthesis procedures are described in chapter 5.3.

For the symmetrically substituted dithioethers (**D**), a ring opening of epichlorhydrin was achieved via nucleophilic attack using alkylthiolates, which were generated in-situ from the ethanolates. Since basic reaction conditions are applied by using the thiolates rather than thiols, compound (**B**) is formed in-situ and subsequently attacked by the second equivalent of thiolate yielding 1,3-dithioprop-2-ols.

GC/MS measurements confirmed purity and identity of all compounds with MS spectra showed peaks for molecular ions and/or fragments thereof. FTIR spectra furthermore exhibited characteristic bands for OH, symmetric and asymmetric CH stretching, as well as epoxide ringmode vibrations. Unambiguous characterisation was achieved using  $^1\text{H}$  and  $^{13}\text{C}$  NMR spectroscopy, which displayed all the expected signals. Interestingly, the NMR spectra of compounds (**C**) and (**D**) show pronounced geminal coupling for the protons in  $\beta$ -positions, as depicted in figure 6. The proton spectra exhibit the expected splitting patterns for ABX systems, which are common for diastereotopic protons.<sup>[167, 168]</sup> The two AB quartets are clearly visible in some cases, but in some cases one half of these quartets is overlapping with other proton signals.

The inset in figure 6 shows one of the examples of an ABX system with no overlapping effects making it easy to determine the coupling constants.  $J_{\text{AX}}$  and  $J_{\text{BX}}$  are the distances between two neighbouring low- or high intensity lines, respectively, while  $J_{\text{AB}}$  can be found four times as the difference between a low- and a high-intensity peak. In our case, the  $^1\text{H}$  NMR spectra usually show multiplets for the X signals since the lines of the expected splitting pattern overlap.

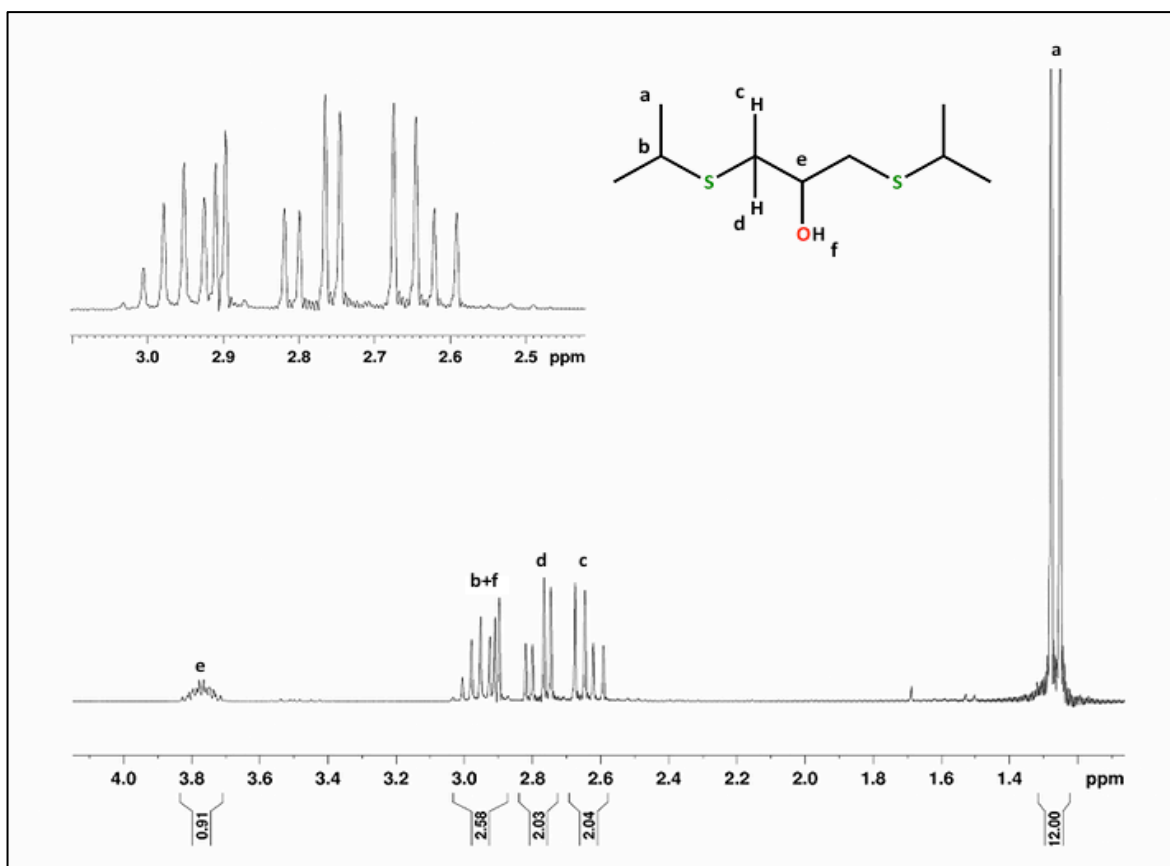

Figure 6:  $^1\text{H}$  spectrum of compound 3. Inlet shows the magnified region of the spectrum for protons b,c and e.

Synthesis of tertiary alcohols was initially attempted via oxidation of the secondary analogues to ketones and subsequent Grignard reaction, as shown in figure 7. Unfortunately, the oxidation reaction could not be realised in this thesis, although various techniques were applied. Neither harsh conditions applying Collins oxidation using  $\text{CrO}_3 \cdot \text{Pyridine}_2$ , nor softer conditions, such as Swern or Dess-Martin oxidation, resulted in the desired ketones; at least for amino-donor bearing secondary alcohols. Therefore, a new multi-step approach was developed similar to the synthesis of the secondary alcohols. The synthesis strategy is illustrated in a retrosynthetic reaction scheme, which is depicted in figure 7.

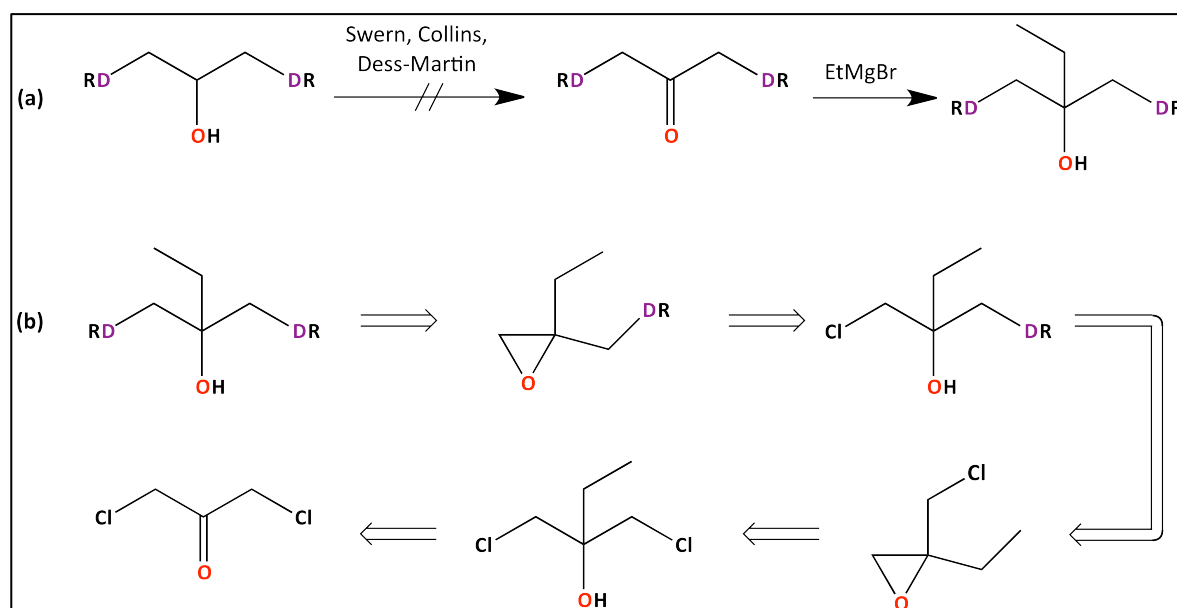

Figure 7: Attempted synthesis of tertiary alcohols (a), retrosynthetic approach (b), D = donor.

Novel tertiary alcohols have been subsequently synthesised as depicted in figure 8. The reaction procedures are described in detail in chapter 5.3. Notably, the synthesis of (**E**) from 1,3-dichloroacetone exclusively yielded the desired adduct (**E**) and no chlorine substitution or condensed products due to Mg insertion into the  $\text{CH}_2\text{-Cl}$  bond were found. For this reason, harsher conditions using alkaline reagents have been avoided. The synthesis of (**G**) and (**H**) has been achieved via reaction of the epoxide with one equivalent of thiolate in ethanol. This reaction leads to higher yields of the dithioether (**H**) at increased temperatures, while decreased percentages are obtained at lower temperatures. Furthermore, formation of ethoxy-group bearing alcohols – due to addition of ethanol to the epoxides via ethanolate attack – was observed when refluxing the reaction mixture, but could also be suppressed by lower reaction temperatures. However, the used reaction conditions resulted in moderate yields (30-50 % for (**G**), 7-20 % for (**H**)). Alternatively, selective syntheses of (**G**) and (**H**) are possible via identical reaction pathways described for the secondary analogues ((**B**) and (**D**)). Synthesis of compounds (**I**) was achieved in the same manner as the secondary analogues by reaction of epoxide (**H**) with diethylamine in presence of a  $\text{LiClO}_4$  catalyst.

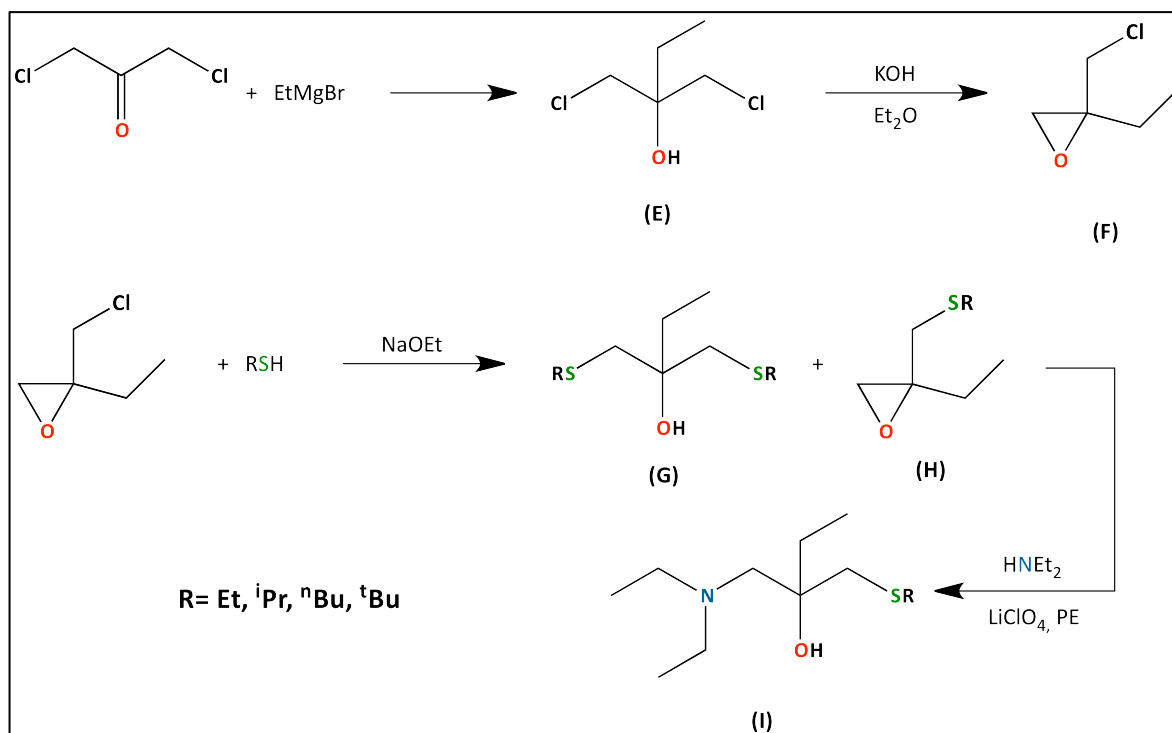

Figure 8: Synthesis of tertiary alcohols.

Complete characterisation of the organic compounds was accomplished via FTIR,  $^1\text{H}$  and  $^{13}\text{C}$  NMR, as well as GC/MS measurements. NMR and FTIR spectra showed the expected peaks and bands for all compounds. GC/MS also confirmed the identity and purity of all compounds. Interestingly, no molecular peaks were found for neither secondary nor tertiary asymmetric ligands, not even for the ethyl or isopropyl species with lower molecular weight. A comparison of GC/MS spectra of symmetric and asymmetric ligands is presented in figure 9.

Figure 9: EIMS spectra of compounds **25**, **4**, **18**.

Figure 9 shows that the symmetric alcohol **18** exhibits peaks for the molecular ion ( $m/z=236.07$ ), as well as the expected fragment with one abstracted isopropyl group ( $m/z=193.03$ ). Moreover, a large number of different fragments with low intensities can be observed in addition to the prominent peaks. On the contrary, the asymmetric alcohols **25** and **4** show only few peaks, the most pronounced of them being the  $\text{Et}_2\text{NCH}_2^+$ -ion ( $m/z=86.06$ ). Interestingly, no peak for the residual molecule ion (intact molecule –  $\text{Et}_2\text{NCH}_2$ ,  $m/z=147.08$ ,  $119.05$  for **25** or **4**, respectively) could be found and the presence of a relatively strong signal for acetone ( $m/z=58.08$ ) indicates almost complete disintegration of the

alcohols, splitting of both donors as well as the ethyl group in the case of the tertiary compound **25**. These observations may indicate lower stability of the asymmetric ligands compared to their symmetric counterparts.

Obviously, the developed synthesis routes allow an easy variation of the donor sites of the alcohols and therefore specific tailor-made molecules can be designed depending on the area of interest. In particular, for our system it is possible to investigate the influence of inductive effects on the donating behaviour of both nitrogen and sulphur by choosing adequate amines or thiols, respectively. Furthermore, steric and electronic effects can be studied by adapting the alkyl group at the  $\alpha$ -position via the Grignard reagent. For instance, electron-withdrawing groups would weaken the resulting metal-oxygen bonds in the alkoxides and therefore strengthen the metal-donor bond.

## 3.2 Alkoxide Synthesis

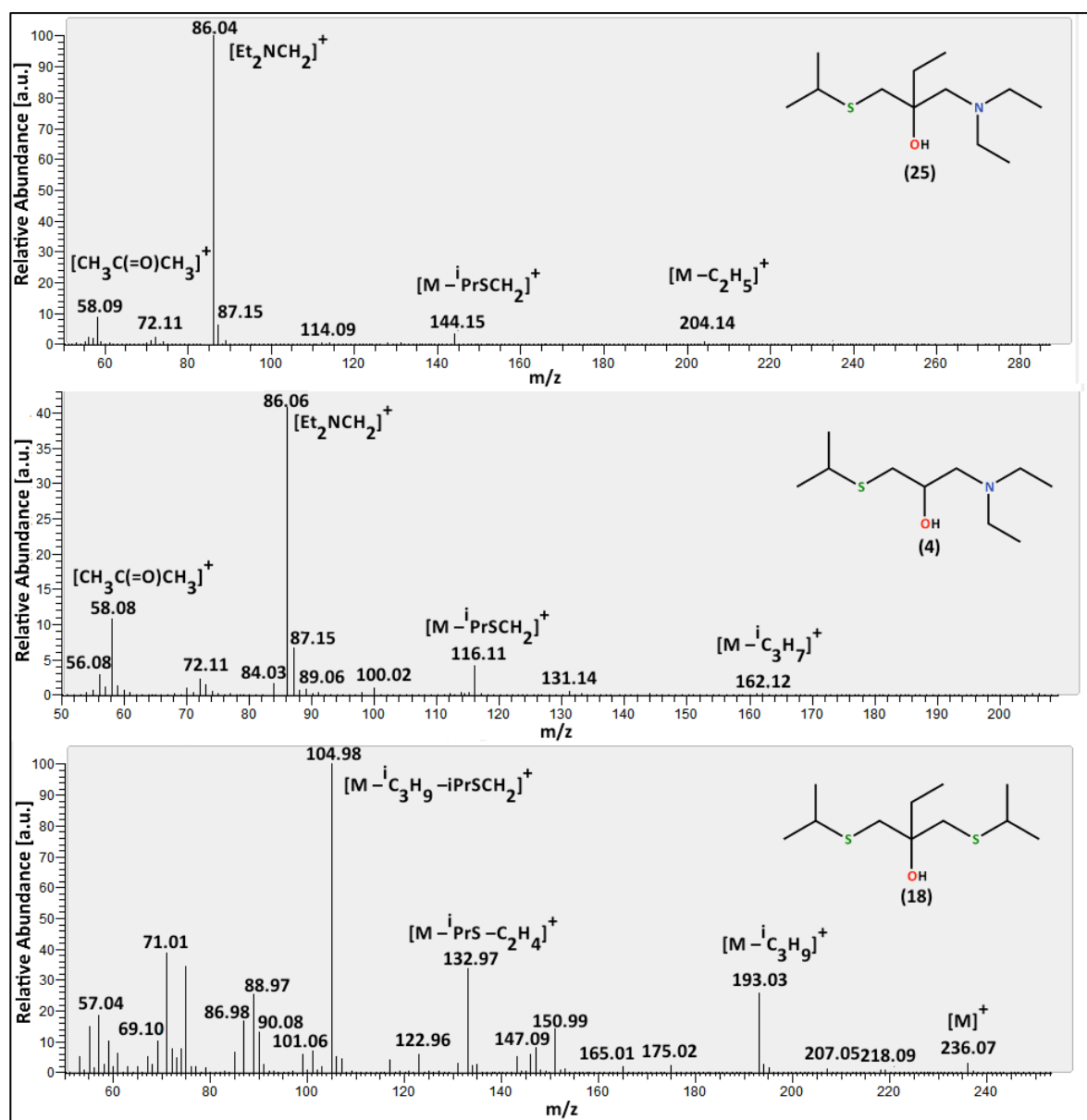
---

The synthesis of the alkoxide species was achieved by methods described in detail in section 1.2 (for explicit procedures see section 5.4). In particular, alcohol exchange reactions were applied for all gallium complexes, while indium species were synthesised using alcoholysis of amides and alcohol exchange reactions as depicted in figure 10. To the best of our knowledge, none of the synthesised compounds has been reported in literature.



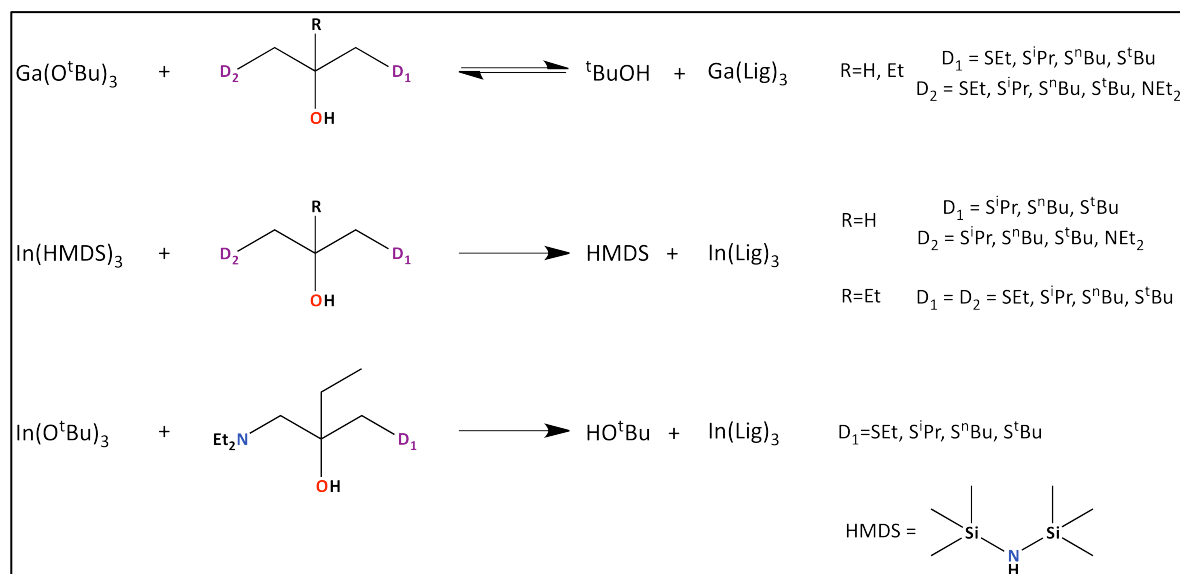

Figure 10: Alkoxide synthesis.

For the synthesis of the gallium species via alcohol exchange starting from  $\text{Ga}(\text{O}^t\text{Bu})_3$  it was necessary to substitute the tert.-butoxide stepwise by removing volatile side products and eventually adding a few drops of additional alcohol to drive the reaction equilibrium towards complete substitution. As expected, secondary alcohols exchanged faster than the tertiary analogues simply due to lower steric demand. All secondary, as well as the symmetric tertiary indium alkoxides were synthesised starting from  $\text{In}(\text{HMDS})_3$ , which undergoes clean and fast amine elimination. Minimal excess of alcohol (3.05 equiv.) and low reaction temperatures (room temperature – 55 °C) were sufficient to yield the alkoxides in high purity. It was not possible to use the amine elimination for the gallium alkoxides since the metal centre in  $\text{Ga}(\text{HMDS})_3$  is shielded very efficiently by the bulky ligand due to the smaller size of the central atom making nucleophilic attack almost impossible. Preliminary experiments showed that  $\text{Ga}(\text{HMDS})_3$  does not undergo any ligand exchange with tert.-butanol, not even in the presence of small amounts of methanol as a catalyst.

For the exchange reactions with asymmetric tertiary alcohols and  $\text{In}(\text{HMDS})_3$ , however, it was found that a yet unidentified rearrangement reaction occurred after a certain degree of ligand exchange leading to a most likely heteroleptic species. The resulting molecular species has not been characterised due to the complexity of the system. The presence of upfield shifted peaks in the  $^1\text{H}$  NMR spectra (0.05-0.18 ppm) points toward the formation of some

kind of indium alkyl species; however, unexpected splitting patterns and the integral ratios were observed, which were not in accordance with simple indium alkyl species. Therefore, further extensive investigations would have been necessary to solve the structure of the resulting compounds, which was not targeted in the given time frame. Nevertheless, it was possible to circumvent the side reaction by synthesising the asymmetric tertiary indium-alkoxides via alcohol exchange reactions using  $\text{In}(\text{O}^t\text{Bu})_3$ . Purification of the tertiary alkoxides was achieved by applying high vacuum at elevated temperatures for several hours in order to remove all traces of excess alcohol.

### 3.3 NMR Studies

---

The secondary, symmetric gallium and indium alkoxides (**33-35** and **39-41**) exhibit very similar properties. All compounds display fluxional sulphur-donation in solution judging from their  $^1\text{H}$  and  $^{13}\text{C}$  NMR spectra, as depicted exemplary in figures 11 and 12. Besides the obvious downfield shift of the O-CH groups, as well as the neighbouring  $\text{CH}_2$  protons due to alkoxide formation, the  $^1\text{H}$  spectra all exhibit rather small changes in the chemical shifts. Broad peaks for the alkyl protons in vicinity of the sulphur donor indicate fluxional coordination behaviour of the donor groups. Donating and non-donating configurations lead to two signals with only small differences in chemical shift, which can therefore not be separated by the used room temperature NMR causing broader peaks. In the  $^{13}\text{C}$  spectra, this effect is not as strong as in the  $^1\text{H}$  spectra since the sensitivity of the measurement is much lower. Nevertheless, small changes (0.1-0.25ppm) in chemical shift can be found for the carbon atoms next to the sulphur donor. The chemical shifts of these signal is most probably an average value between a donating and a non-donating form of the molecule leading to only small changes in the chemical shift.

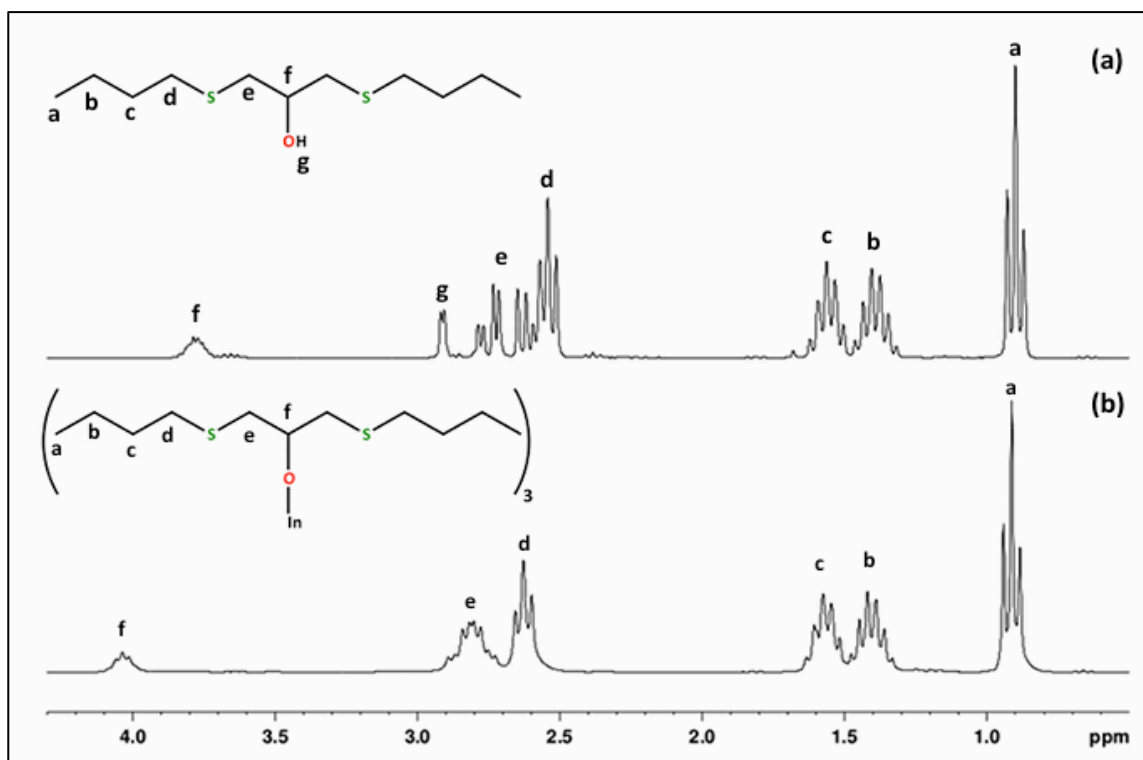

Figure 11:  $^1\text{H}$  NMR spectra of compound 7 (a) and 40 (b).

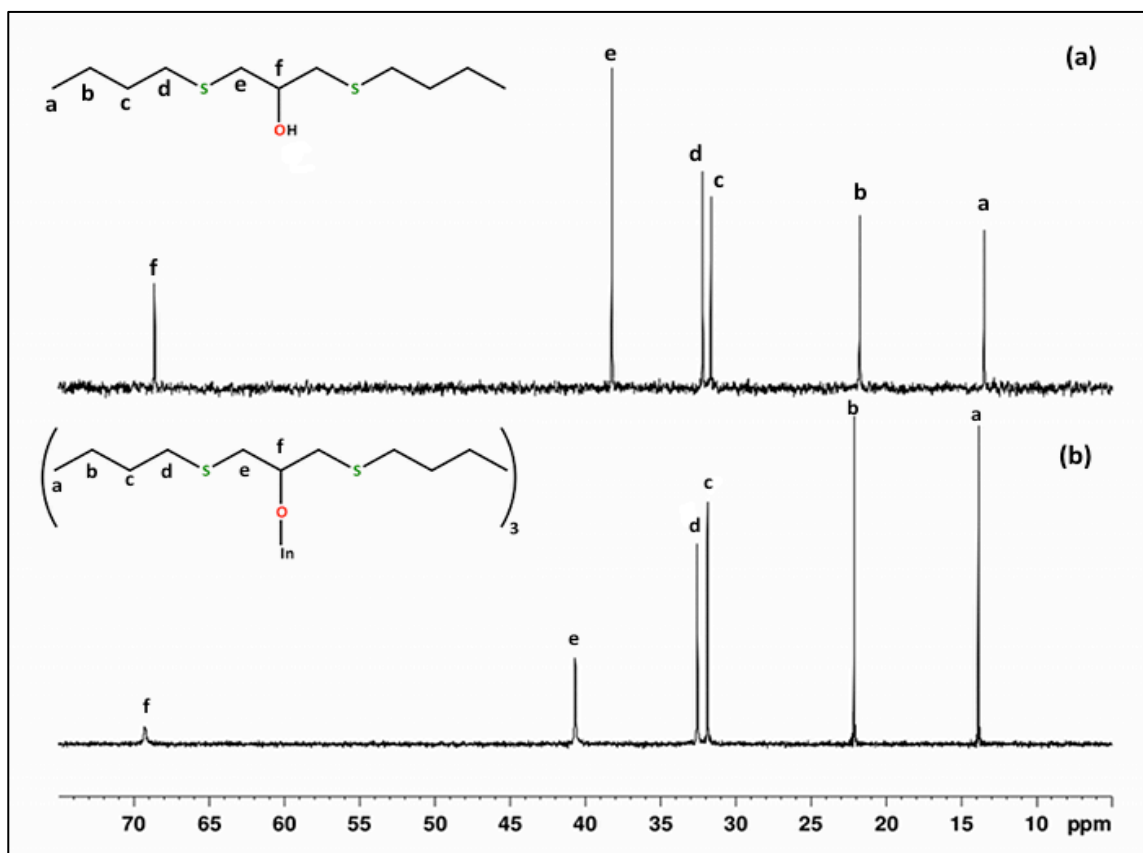

Figure 12:  $^{13}\text{C}$  NMR spectra of compounds 7 (a) and 40 (b).

Interestingly, the secondary gallium species **34**, as well as its tertiary analogue **48**, with two <sup>n</sup>butylthio donors show unique behaviour in <sup>13</sup>C NMR. Signals in vicinity to the sulphur donor (both CH<sub>2</sub> groups next to the sulphur atoms), the C<sub>α</sub> and the CH<sub>2</sub> group of the ethyl chain in case of the tertiary alkoxide exhibit two lines per signal, as depicted in figure 13. This effect was not encountered in any of the other symmetric gallium species or its indium analogues. It is possible that the flexibility of the <sup>n</sup>butyl chain allows for easier coordination making the donation more stable compared to the other donor groups, which would lead to a less fluctuational behaviour and therefore to a better visibility of these signals in the <sup>13</sup>C NMR spectra. For deeper insight into the underlying effects it would be necessary to conduct variable temperature NMR spectroscopy and further investigations, which will be conducted in the near future.

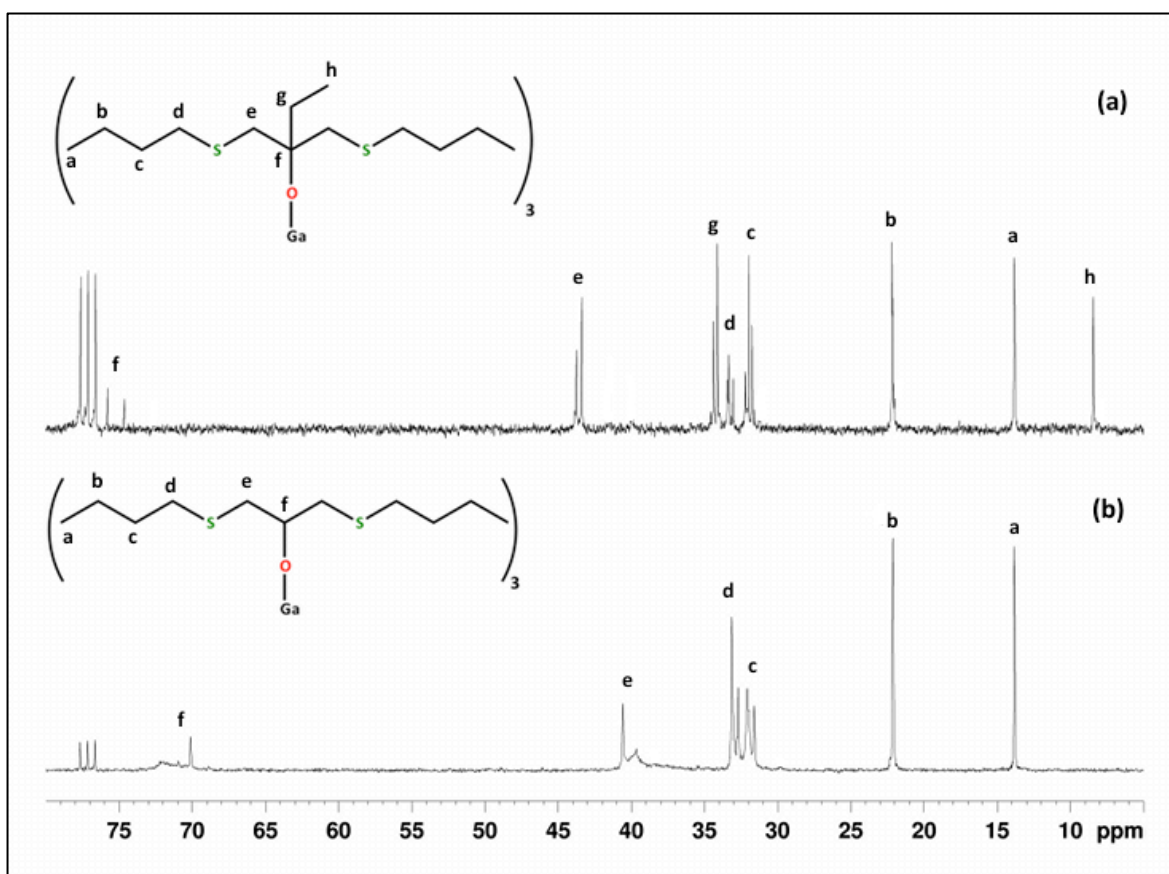

Figure 13: <sup>13</sup>C NMR spectra of compounds **48** (a) and **34** (b).

For the asymmetric, secondary alkoxides (**36-38** and **42-44**) an interesting feature arises. In  $^1\text{H}$  NMR spectra, all signals originating from the alkyl groups attached to the sulphur atom are scarcely shifted and appear as sharp signals with similar split when compared to the ligand spectra. On the other hand, signals of groups directly attached to the nitrogen donor are downfield shifted for approximately 0.2 ppm. This effect is especially visible for the  $\beta$ - $\text{CH}_2$  groups. As depicted in figure 14, the methylene group next to the sulphur atom hardly shifts, while the methylene group in vicinity to the nitrogen atom is shifted downfield. These findings indicate a donation of the nitrogen to the metal centre, while the sulphur atom does not coordinate in this 'competitive' arrangement of the asymmetric ligands.

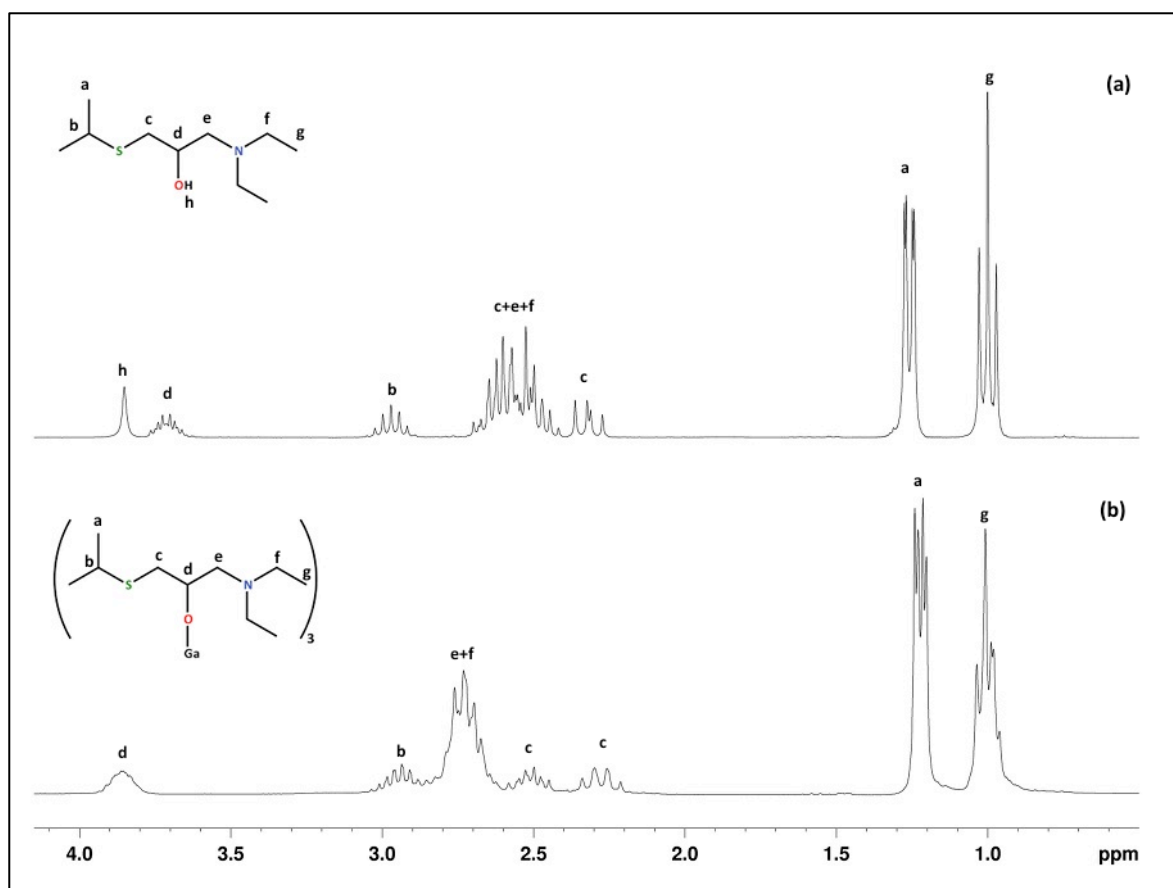

Figure 14:  $^1\text{H}$  NMR spectra of compounds **4** (a) and **36** (b).

In  $^{13}\text{C}$  NMR spectra, a similar effect has been observed (figure 15). Signals of groups attached to the nitrogen donor, as well as the  $\alpha$ -carbon exhibit two or even three peaks. These signals are most probably originating from the additional coordination of two or three nitrogen donors to the metal centre. This leads to a change in the metal's electron density and

therefore could be responsible for the varying chemical shifts of the groups in vicinity. Interestingly, while the  $C_{\alpha}$  signals are shifted downfield for approx. 2 ppm, the diethylamino signals are shifted upfield about 2.4 and 2.8 ppm, respectively. Signals of carbon atoms directly attached to the sulphur donor show one or two peaks (the small changes in the chemical shift arises most probably because of nitrogen donation), while the other signals of the alkyl group attached to the sulphur appear as sharp, single lines that are scarcely shifted compared to the free ligand. These findings are therefore in agreement with the hypothesis that nitrogen coordinates to the metal centre while sulphur is free and not coordinating.

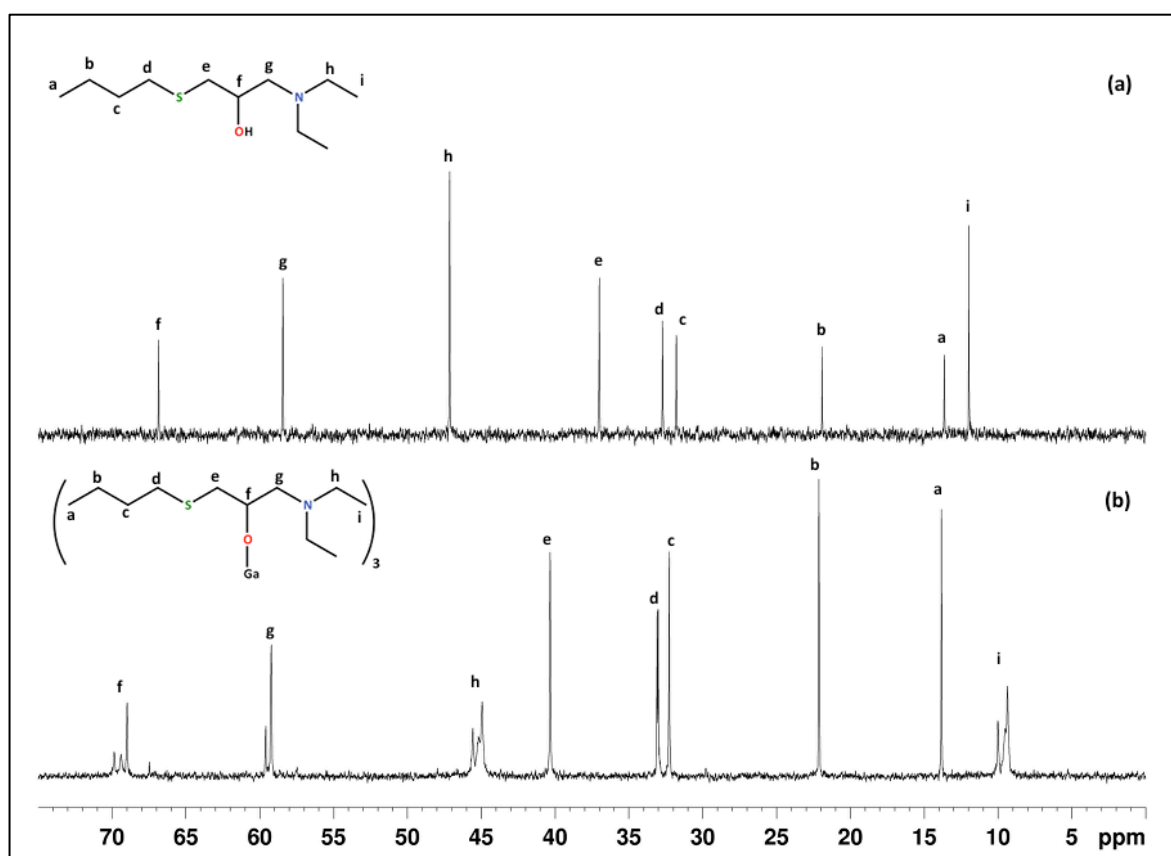

Figure 15:  $^{13}\text{C}$  NMR spectra of compounds 8 (a) and 37 (b).

For the tertiary, symmetric alkoxides (**46-49** and **54-58**) the same trend as for the secondary counterparts can be observed.  $^1\text{H}$  NMR spectra exhibit broadened peaks for the groups in vicinity to the sulphur donor, again indicating weak sulphur-metal interactions in fluctuational behaviour for gallium and indium species. The introduced ethyl chain at the  $\alpha$ -carbon does not seem to have any major impact on the donor behaviour/activity compared to the

secondary alkoxides described above. The differences between free ligand and alkoxides are clearly visible in  $^{13}\text{C}$  NMR spectra, though (see figure 16). In general, the same trends in shift for gallium and indium species are observed. The ethyl group at the  $\alpha$ -carbon is shifted downfield (0.4 and 2.1 ppm for Ga and 0.45 and 2.8 ppm for In, respectively), as are the carbon atoms in vicinity to the sulphur atoms (0.2-0.4 and 2.0-2.3 ppm for Ga and 0.1-0.4 and 2.9-3.5 ppm for In). The most obvious difference between the gallium and indium species is the shift of the  $\alpha$ -carbon. While gallium species exhibit a downfield shift of approx. 1.4-1.9 ppm, indium species show an upfield shift of 0.5-1.4 ppm. This effect might be due to different coordination modes. For the gallium species, which prefer a tetrahedral coordination sphere, it is harder to further coordinate a donor due to its smaller size. Indium on the other hand is known to also show octahedral arrangements, which would allow for easier coordination of the sulphur donors. This could lead to more electron density transferred to the metal centre, thus lowering the electron pulling effect on the metal-oxygen bonds and therefore leading to an upfield shift of the  $\text{C}_\alpha$ .

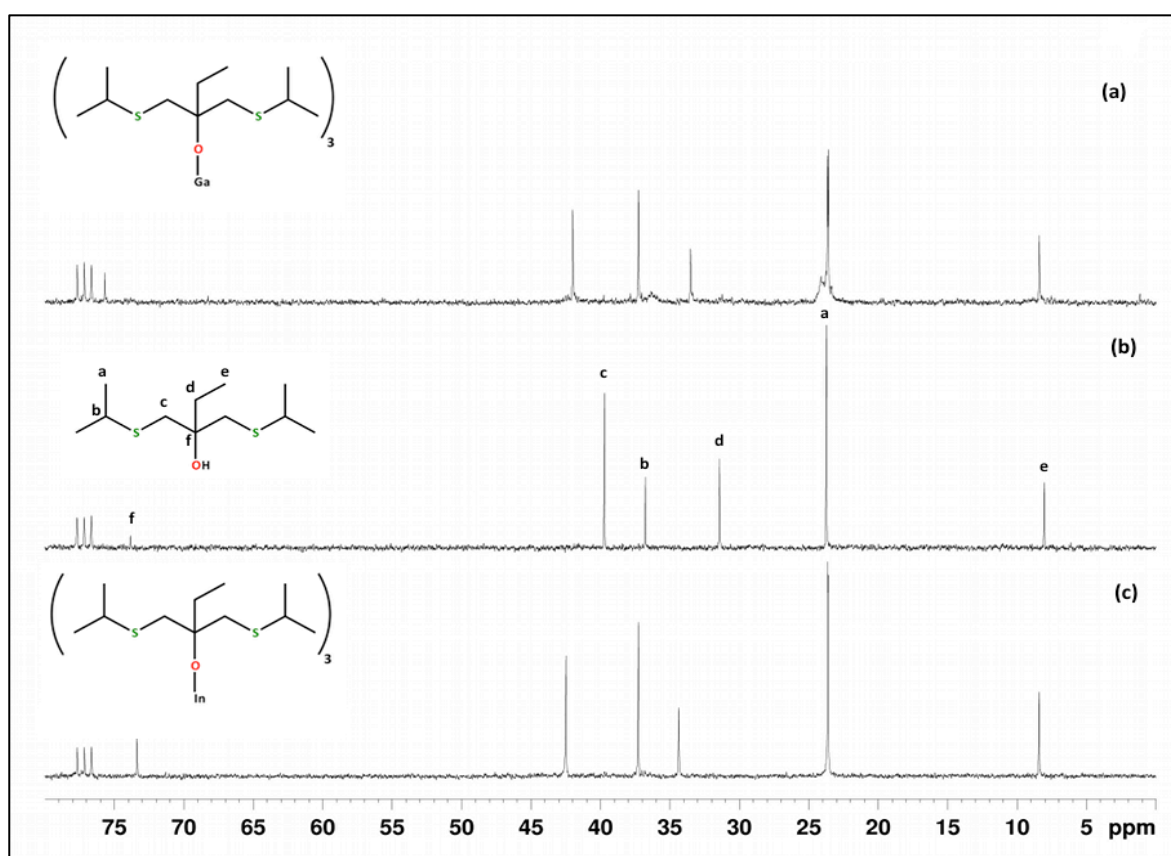

Figure 16:  $^{13}\text{C}$  NMR spectra of 47 (a), 18 (b) and 56 (c).

Compounds **45** and **54**, bearing two ethoxy groups as donors, were synthesised for comparison of the yet unknown sulphur donor with the well-investigated ether-moieties. As expected, the signals of the ethoxy moiety were shifted stronger than any of the signals for the alkylthio groups. In the  $^1\text{H}$  NMR spectra (see figure 17), the  $\text{CH}_2$  signal of the ethoxy group is shifted downfield for 0.11 and 0.16 ppm for Ga and In, respectively; however, the signals for the ethylthio analogues (**46** and **55**) shift merely for 0.07 and 0.06 ppm. Furthermore, the stronger donating character of the ether can be observed in the shift of the  $\beta\text{-CH}_2$  groups. These are shifted to lower frequencies (0.03 and 0.09 for Ga and In, respectively), while they are shifted to higher frequencies for all alkylthio-functionalised alkoxides. These findings indicate a strong interaction between the metal centre and the ethoxy-donor groups. The  $^{13}\text{C}$  NMR spectra confirm these findings as they show similar behaviour. The  $\text{CH}_2$ -signals of the ethoxy groups are shifted downfield for about 0.9 and 1.2 ppm for Ga and In, respectively, when compared to a 0.2 ppm shift for the ethylthio analogues. The  $\beta\text{-CH}_2$  peaks on the other hand are shifted downfield for only 0.1 ppm for the ethoxy species, while they are shifted 2.0 and 3.3 ppm for the gallium and indium ethylthio species, respectively. Furthermore, the  $\alpha$ -carbon exhibits a shift to lower frequencies (0.2 and 1.9 ppm for Ga and In), which is in contrast with the findings for the alkylthio-functionalised gallium alkoxides (**46-49**). Instead of the upfield shift observed here, the symmetrical alkylthio-alcoholates exhibit a downfield shift of the  $\text{C}_\alpha$  signals (average of 1.4 ppm). The shift is more pronounced for the indium alkoxides, which generally exhibit an upfield shift (0.5-1.4 ppm) for the tertiary symmetric species (**55-58**).



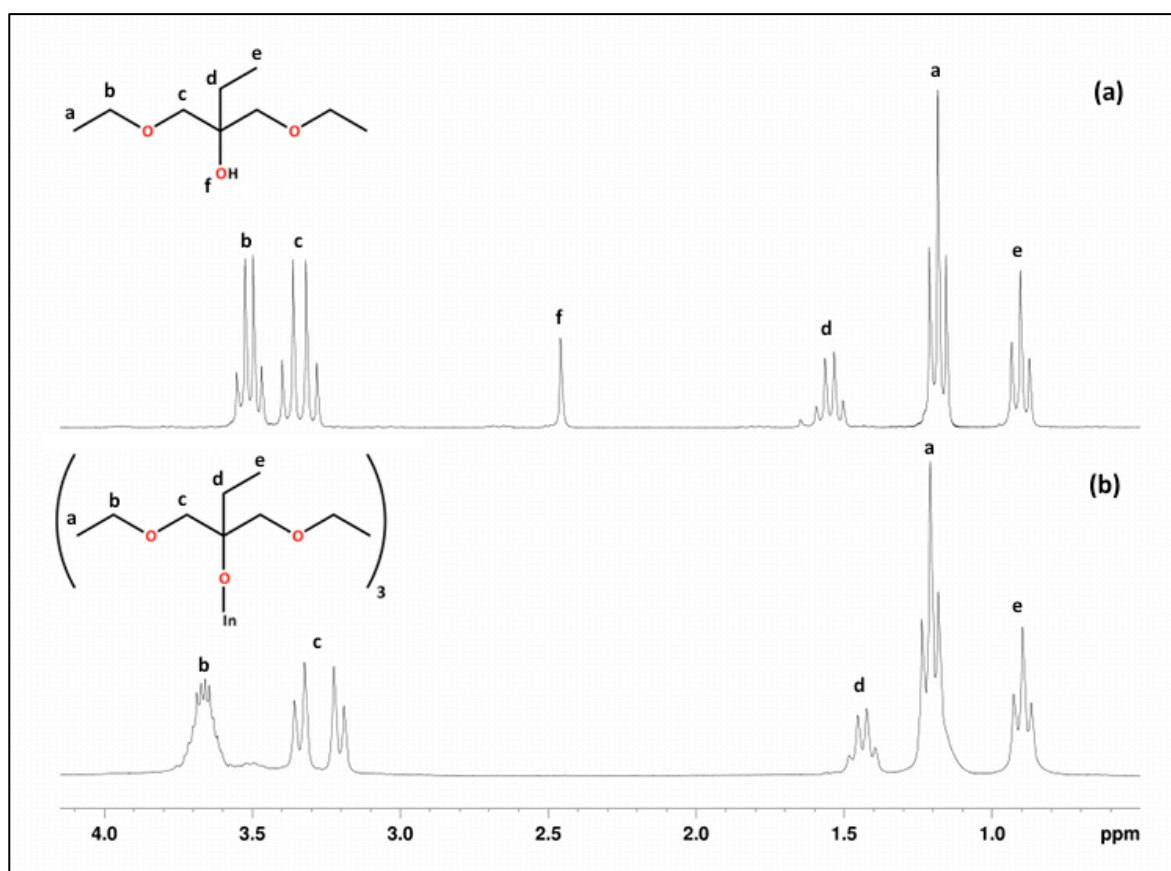
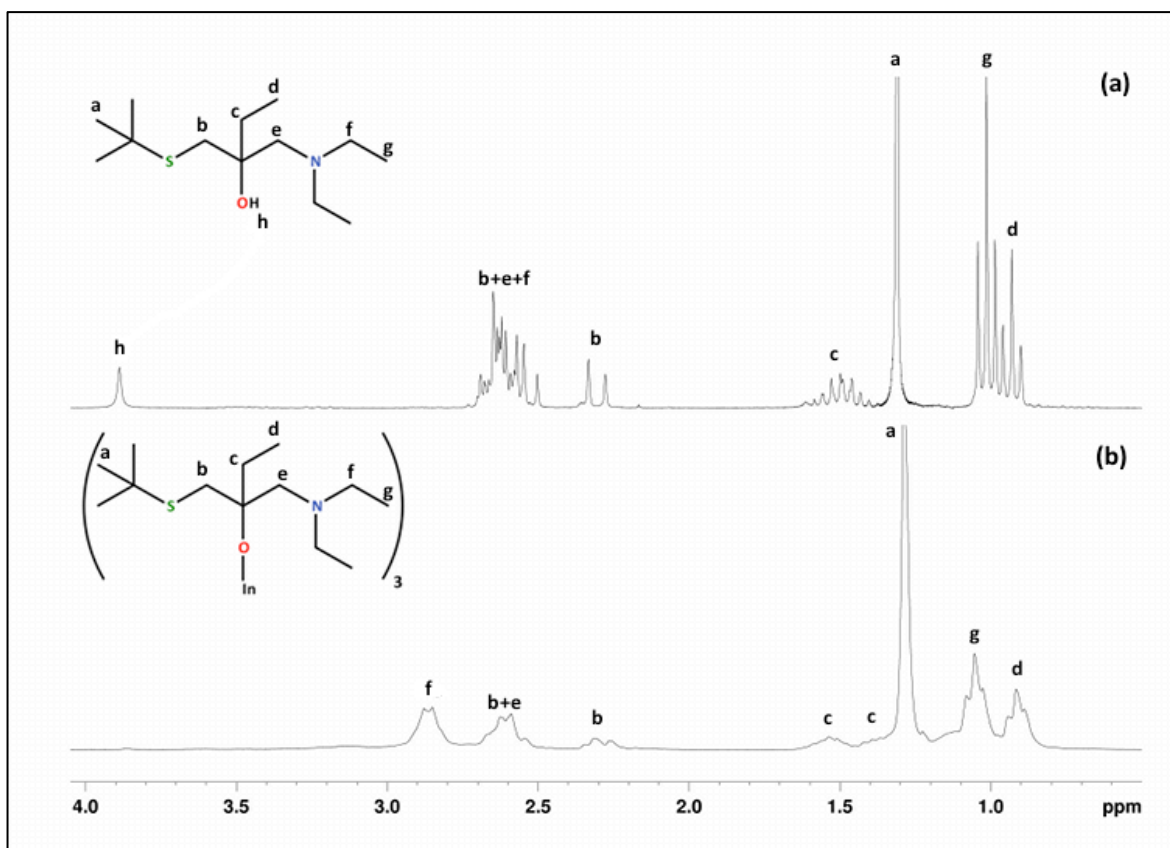
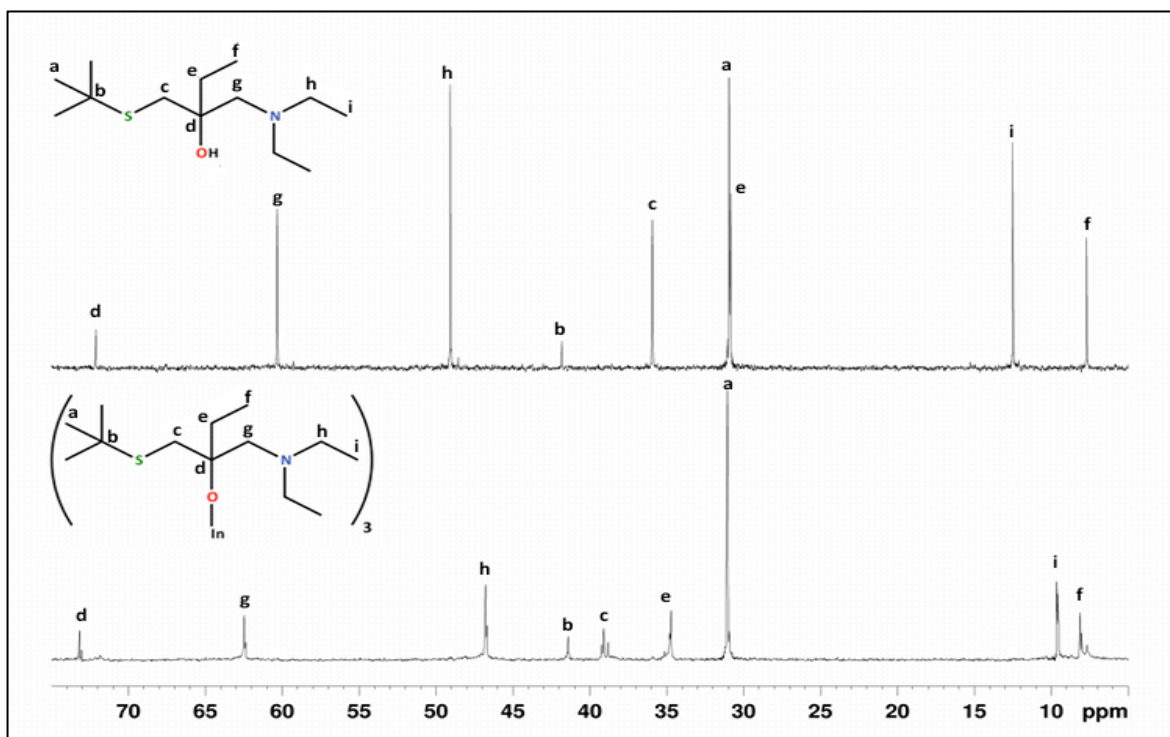

Figure 17:  $^1\text{H}$  NMR spectra of compounds 15 (a) and 54 (b).

The tertiary, asymmetric alkoxides (**50-53** and **59-62**) behave very similar to their secondary counterparts. For both, gallium and indium species,  $^1\text{H}$  NMR spectra exhibit almost no shift for the alkylthio-signals, while the signals of groups in vicinity of the nitrogen donor show a rather pronounced downfield shift and often broadened signals (figure 18). A difference to the secondary alkoxides can be found in the introduced ethyl chain, which shows a split of two multiplets upon formation of the alkoxides instead of one quartet or multiplet as found for the ligands, which is most likely due to the chiral nature of the  $\text{C}_\alpha$ . As depicted in figure 19,  $^{13}\text{C}$  NMR signals originating from carbon atoms in vicinity to the nitrogen donor, as well as the  $\text{C}_\alpha$  and the introduced ethyl chain exhibit two or three lines per expected signal, while the signals of the alkylthio groups once more appear as hardly shifted single peaks. These findings lead to the conclusion that also for the tertiary asymmetric alkoxides nitrogen shows the stronger donation/interaction with the metal centre leading to a non-donating configuration of the sulphur.

Figure 18:  $^1\text{H}$  spectrum of compounds **27** (a) and **62** (b).Figure 19:  $^{13}\text{C}$  NMR spectra of compounds **27** (a) and **62** (b).

### 3.4 Single Crystal XRD

For further investigation of the coordination behaviour in the solid state, we conducted single crystal X-Ray diffraction (XRD). Unfortunately, in the course of this thesis only one compound could be crystallised due to the mostly viscous nature of the alkoxide derivatives at room temperature and a very slow solidification process of a few species at lower temperatures. Crystals of the indium alkoxide **58** were obtained from a highly concentrated <sup>n</sup>pentane solution. The crystals did not show a distinct habitus and formed preferentially thin platelets. The morphology and the overall quality of the crystals was not ideal resulting in a limited scattering up to approx.  $\theta=20^\circ$  and thus to a resolution of only 1 Å. Nevertheless, the obtained data allows a qualitative analysis of the structural features of compound **58** in the solid state. The calculated crystal structure is depicted in figure 20 and the corresponding preliminary crystallographic data is summarised in table 1.

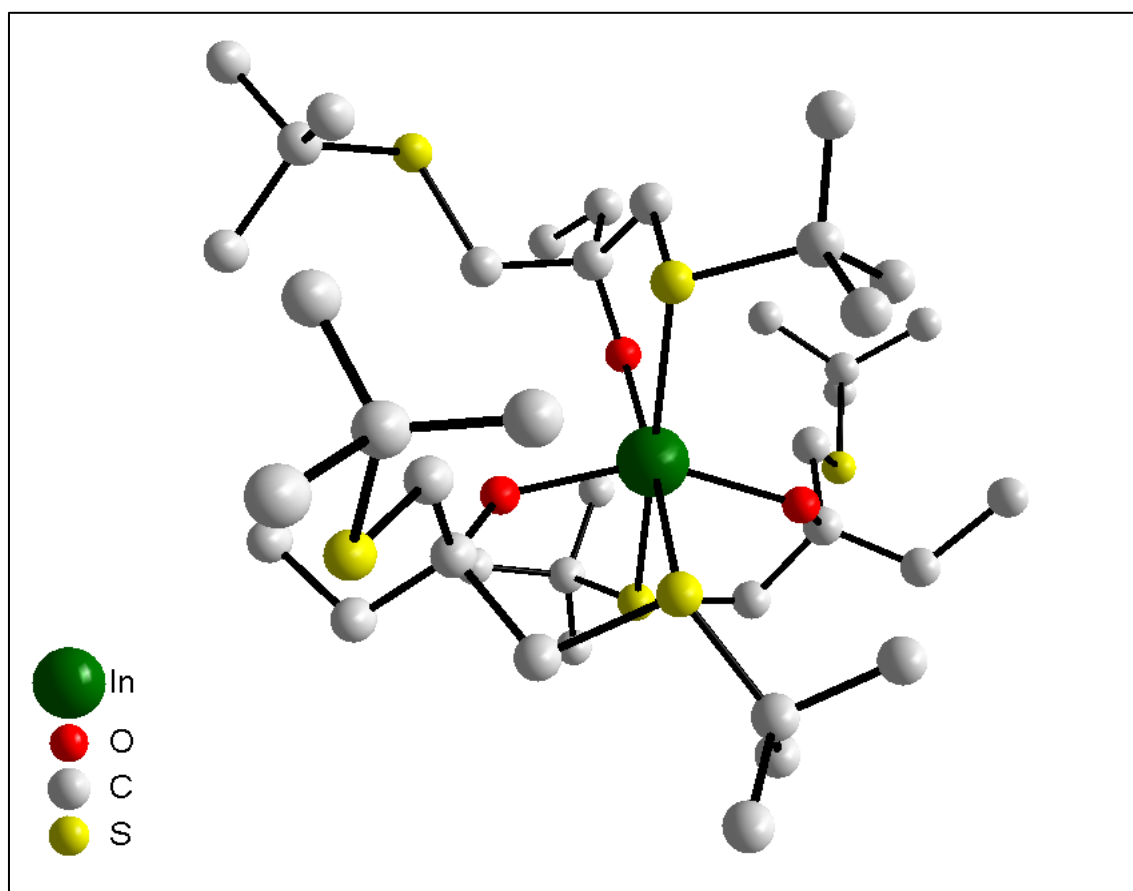

Figure 20: Preliminary crystal structure of compound **58**. Hydrogen atoms are omitted for clarity.

Table 1: Crystal data of compound **58**.

Crystal data	
Chemical formula	InO <sub>3</sub> S <sub>6</sub> C <sub>39</sub> H <sub>81</sub>
M [g/mol]	905.26
Cell setting, space group	triclinic, $P\bar{1}$
Temperature [K]	100
a, b, c [Å]	10.4173(13), 10.8235(11), 22.611(3)
$\alpha, \beta, \gamma$ [°]	94.440(5), 96.910(6), 107.590(5)
V [Å <sup>3</sup> ]	2395.0(5)
Z	2
Refinement	
Refinement on	F <sup>2</sup>
R[F <sup>2</sup> > 2 $\sigma$ (F)], $\omega$ R(F <sup>2</sup> ), S	0.1493, 0.4004, 2.923

The substance crystallises in the triclinic space group  $P\bar{1}$  and exhibits two molecules per unit cell. Figure 20 shows the monomeric nature of **58** in the solid state. The coordination sphere of the indium centre contains three oxygen atoms of the alkoxo-groups and one sulphur atom per ligand. The second sulphur-containing side chain is not coordinating as could be predicted due to the tendency of indium compounds not to exceed six-fold coordination. The three coordinating sulphur atoms are in meridial positions to form an irregular octahedron due to different In-O and In-S bond lengths. Similar coordination spheres were reported before for homoleptic indium  $\beta$ -diketonates and heteroleptic alkoxides.<sup>[22, 37, 169, 170]</sup> However, to best of our knowledge, this is the first report of a homoleptic monomeric indium alkoxide containing sulphur donor moieties.

The observations of the coordinating sulphur donors are in good agreement with the NMR data presented above, which indicated fluxional coordination behaviour in solution. The coordination of three additional donors is the highest number of donor species expected to interact with the metal centre. Since most compounds are viscous liquids, the formation of monomeric compounds is probably achieved for all described alkoxides. Dimeric species

would have molecular weights greater than 1500 g/mol and thus are most likely solids. However, fluctuations due to thermal vibrations are most likely responsible for the low tendency to crystallise. The crystallisation of the specific compound **58** described here is most probably the result of the combined effects of steric shielding and increased inductive effects of the attached <sup>t</sup>butyl unit, which inhibit/reduce the tendency of thermal fluctuations and thus lead to quicker growth of a crystalline solid.

### 3.5 Thermal Properties

---

As mentioned in section 1.4.1, the thermal properties of an alkoxide are – among other factors – of importance for being considered an appropriate CVD precursor. Therefore, thermogravimetric analysis (TGA) of the novel alkoxides was carried out to investigate their decomposition behaviour, as well as their volatility.

The TGA measurements (N<sub>2</sub> atmosphere, 35-700 °C) were carried out under inert atmosphere to acquire the presented data. For applications such as CVD, a clean one-step decomposition, as well as a steady volatilisation is desirable. Table 2 shows merely three alkoxides (**33**, **36** and **50**), where evaporation should be taken into account due to the low mass of the residues. In addition, table 1 summarises detrimental information about the decomposition behaviour of the alkoxide species at standard pressure, which is either a one- or a two-step pyrolysis process as shown by two examples in figure 21. Nevertheless, the synthesised alkoxides could be very well suited as CVD precursors since they are all viscous liquids, which should ensure a steady precursor flow under the high-vacuum conditions applied low-pressure CVD process. Furthermore, it is possible that the precursor decomposes in a first step to form an activated intermediate species (i.e. a reducing or oxidising species) supporting the formation of the desired material.

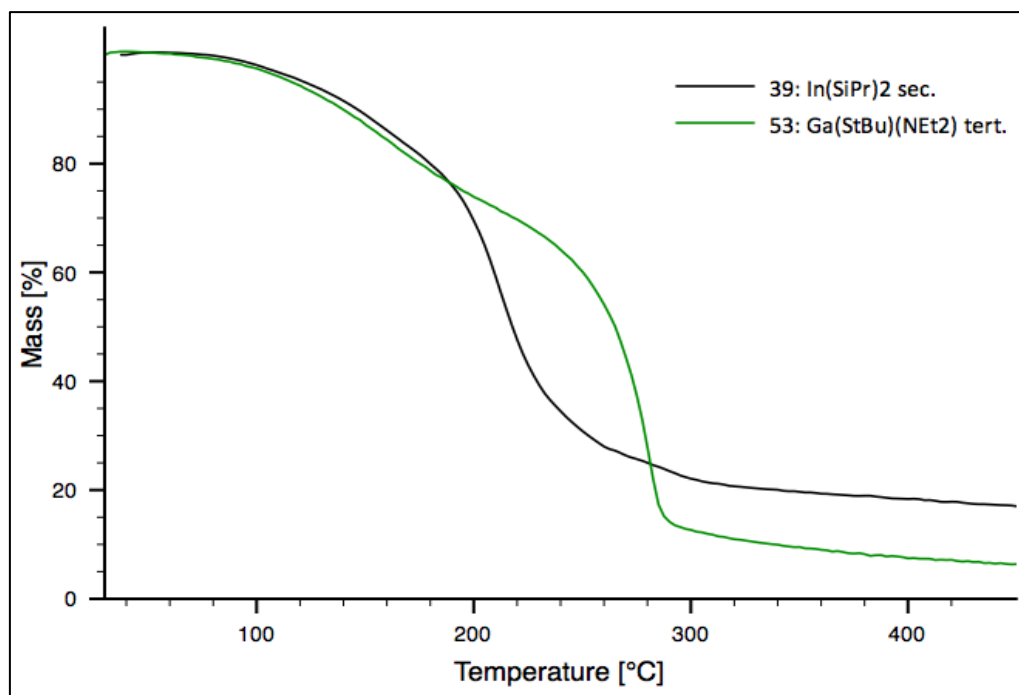

Figure 21: TGA measurements of compounds **39** and **53**.

No distinct trend is observable when comparing gallium alkoxides with their indium analogues, but in general it seems that the decomposition temperatures increase with increasing steric demand of the alkylthio-group ( $\text{Et} < ^i\text{Pr} < ^n\text{Bu} < ^t\text{Bu}$ ). In addition, a tendency of asymmetric alcoholates to decompose in two steps with lower first transition temperatures is observed. The different strength of the carbon-heteroatom bond within the alcohol species is most likely responsible for this observation, because the symmetric counterparts show mostly a single step in weight loss. Unfortunately, the measured first-step mass losses of the asymmetric species fit neither the complete loss of a thiol nor an amine group. Furthermore, most of the residual masses do not fit the calculated values for pure gallium or indium oxide, however some compounds are close (**34**, **44**, **52** and **62**). On average the measured masses are 5-10 % above the desired value for the oxide materials. After the measurements, most of the residues in the crucible were of a grey to black colour indicating that the obtained material was most probably still containing some carbon impurities, which would explain the discrepancies between the measured and calculated values.

Table 2: TGA results of the synthesised alkoxides. The abbreviations merely show the heteroatom containing side chains attached to the alcohol.

Compound	T <sub>1</sub> [°C]	Δm <sub>1</sub> [%]	T <sub>2</sub> [°C]	Δm <sub>2</sub> [%]	Measured residual mass [%]	Calculated residual mass [%]
<b>secondary</b>						
<b>33</b> Ga(S <sup>i</sup> Pr) <sub>2</sub>	138	28.48	232	70.54	0.98	13.55
<b>34</b> Ga(S <sup>n</sup> Bu) <sub>2</sub>	246	89.00			11.00	12.08
<b>36</b> Ga(S <sup>i</sup> Pr)(NEt <sub>2</sub> )	157	23.41	287	68.00	8.59	13.72
<b>37</b> Ga(S <sup>n</sup> Bu)(NEt <sub>2</sub> )	198	16.77	302	63.79	19.44	12.94
<b>39</b> In(S <sup>i</sup> Pr) <sub>2</sub>	213	75.42			24.58	18.84
<b>40</b> In(S <sup>n</sup> Bu) <sub>2</sub> <b>40</b>	207	82.53			17.47	16.01
<b>42</b> In(S <sup>i</sup> Pr)(NEt <sub>2</sub> )	104	35.45	238	41.19	23.36	19.01
<b>43</b> In(S <sup>n</sup> Bu)(NEt <sub>2</sub> )	176	25.26	246	51.82	22.92	18.02
<b>44</b> In(S <sup>t</sup> Bu)(NEt <sub>2</sub> )	243	82.80			17.20	18.02
<b>tertiary</b>						
<b>46</b> Ga(SEt) <sub>2</sub>	211	56.36			43.64	13.54
<b>47</b> Ga(S <sup>i</sup> Pr) <sub>2</sub>	213	61.48	257	9.10	29.42	12.07
<b>48</b> Ga(S <sup>n</sup> Bu) <sub>2</sub>	238	81.53			18.47	10.89
<b>50</b> Ga(SEt)(NEt <sub>2</sub> )	157	27.60	290	64.10	8.30	12.93
<b>51</b> Ga(S <sup>i</sup> Pr)(NEt <sub>2</sub> )	153	26.75	280	58.59	14.66	12.22
<b>52</b> Ga(S <sup>n</sup> Bu)(NEt <sub>2</sub> )	171	37.94	267	52.06	10.00	11.58
<b>53</b> Ga(S <sup>t</sup> Bu)(NEt <sub>2</sub> )	166	24.14	277	60.86	15.00	11.58
<b>54</b> In(OEt) <sub>2</sub>	107	18.52	223	50.80	30.68	21.67
<b>55</b> In(SEt) <sub>2</sub>	160	20.17	248	55.49	24.34	18.84
<b>56</b> In(S <sup>i</sup> Pr) <sub>2</sub>	161	26.45	253	53.25	20.30	16.91
<b>57</b> In(S <sup>n</sup> Bu) <sub>2</sub>	252	76,84			23.16	14.89
<b>59</b> In(SEt)(NEt <sub>2</sub> )	138	35.16	211	43.47	21.37	18.03
<b>60</b> In(S <sup>i</sup> Pr)(NEt <sub>2</sub> )	158	23.97	245	58.27	17.76	16.54
<b>61</b> In(S <sup>n</sup> Bu)(NEt <sub>2</sub> )	185	79.14			20.86	16.25
<b>62</b> In(S <sup>t</sup> Bu)(NEt <sub>2</sub> )	195	84.62			15.38	16.25

Judging only from their TGA measurements, the symmetric alkoxides with <sup>n</sup>butylthio donors (compounds **34**, **40**, **48** and **57**) are the most promising candidates as precursors for LPCVD. All four of them show a one-step transition at moderate temperatures (207-252 °C), as shown in figure 22.

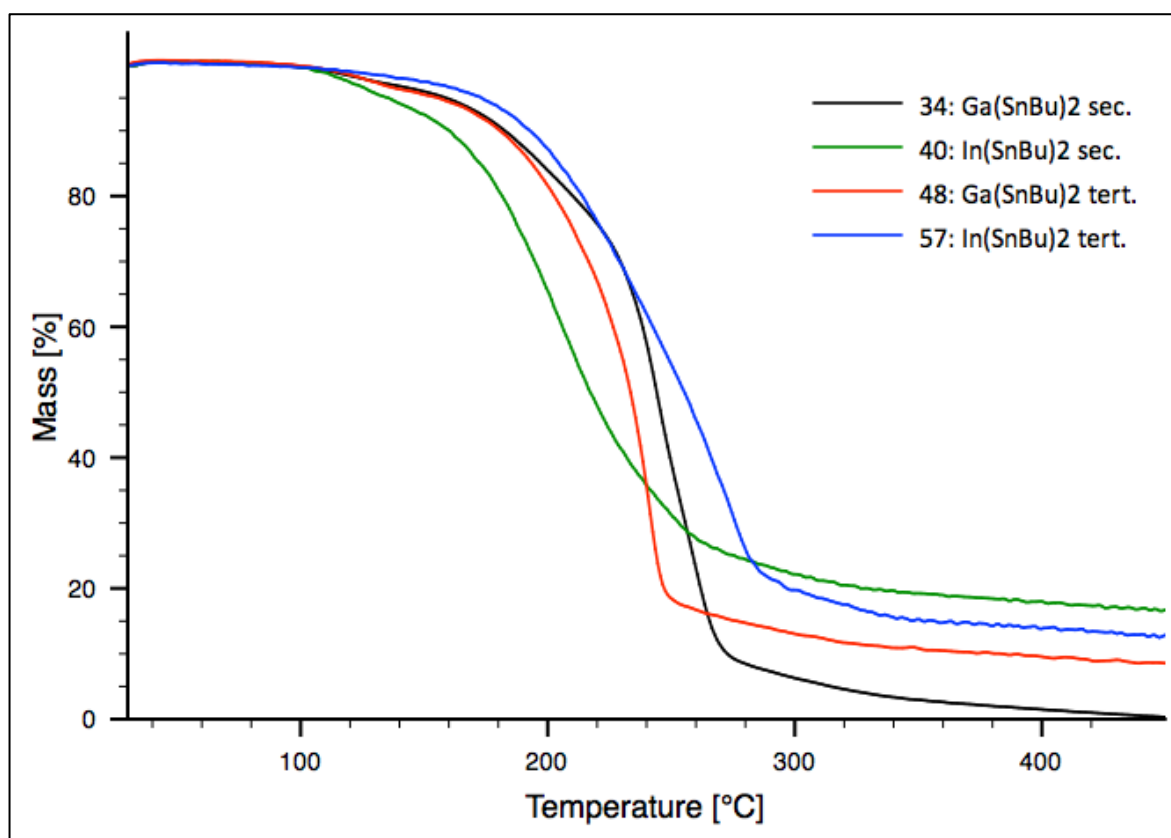

Figure 22: TGA measurements of compounds **34**, **40**, **48** and **57**.

### 3.6 Low-Pressure CVD

Since this work is aiming at the application of the presented alkoxides as single-source precursor systems for LPCVD, we started with the deposition of indium oxide films from  $\text{In}(\text{O}^t\text{Bu})_3$  as a standard precursor to be able to compare the following depositions. Unfortunately, due to the limited time frame it was not possible to gather reliable data of oxide coatings using the novel alkoxides described above. Nevertheless, the presented results serve as a basis for further research. The surfaces were coated in a home-build



horizontal cold-wall quartz tube reactor equipped with a graphite susceptor under high vacuum using a turbo molecular pump. A schematic illustration of the used equipment is shown in figure 23.

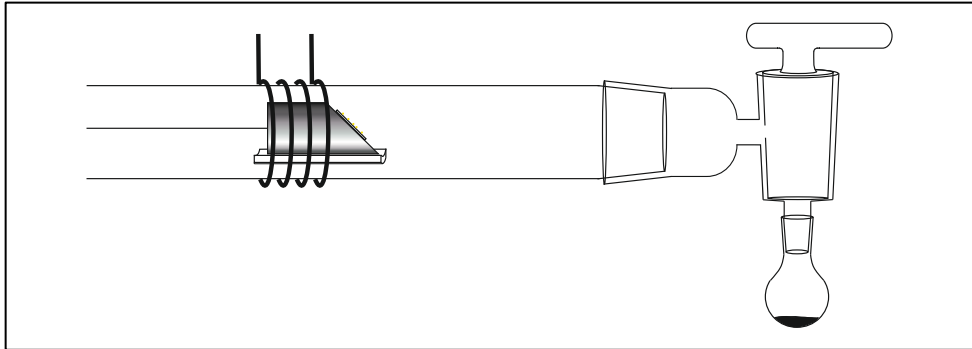

Figure 23: Schematic illustration of the CVD apparatus.<sup>[171]</sup>

For the production of the films on silicon (100) substrates, approx. 100 mg  $\text{In}(\text{O}^t\text{Bu})_3$  were used at a precursor temperature of 85 °C without any addition of a carrier gas in contrast to procedures often described in literature. The substrate temperature was regulated by heat transfer from a graphite susceptor, which was heated inductively coupling with a HF field within the coil as shown in figure 23. Figure 24 (a-c) shows scanning electron microscopy (SEM) images of the deposited films. All coatings show homogeneous  $\text{In}_2\text{O}_3$  coverage with varying particle size depending on the deposition temperature. Since the growth mechanism is governed by an expected island growth on Si (Butler-Volmer growth mode), the crystallite size is increasing with temperature due to increased diffusion kinetics on the substrate surface.

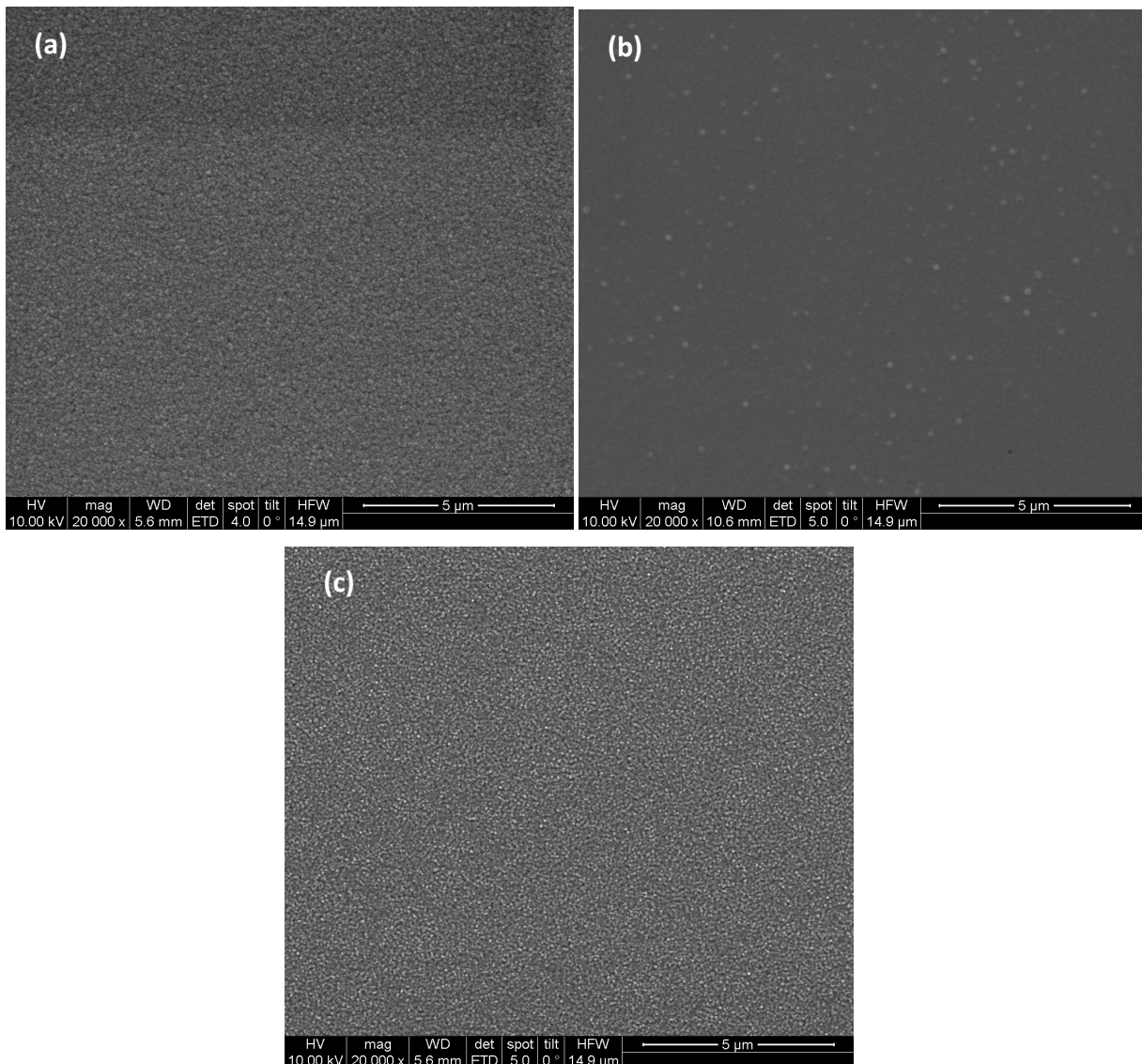

Figure 24: SEM pictures of  $\text{In}_2\text{O}_3$  films deposited at 350 °C (a), 500 °C (b) and 650 °C (c).

Furthermore, figure 25 illustrates representative XRD patterns of indium oxide films. The reflexes in the diffractograms were indexed to phase-pure cubic  $\text{In}_2\text{O}_3$  without any other crystalline phase present. The XRD results and the absence of nanorods in the SEM pictures are an indication that no reduction to metallic indium took place. Sometimes such small impurities are XRD amorphous, but the morphological features already hint towards slightly non-stoichiometric deposits, since the formation of 1D-nanostructures often requires (metallic) liquid droplets for a vapour-liquid-solid (VLS) mechanism.<sup>[172-174]</sup> In addition, energy dispersive X-ray spectroscopy (EDX) investigations at different locations on the substrates showed a very good agreement with the expected In:O ratio of 2:3. These results

will help us to compare these  $\text{In}_2\text{O}_3$  films with the coatings derived from the novel alkoxide species synthesised in this thesis. Similar studies will be carried out for gallium oxide coatings.

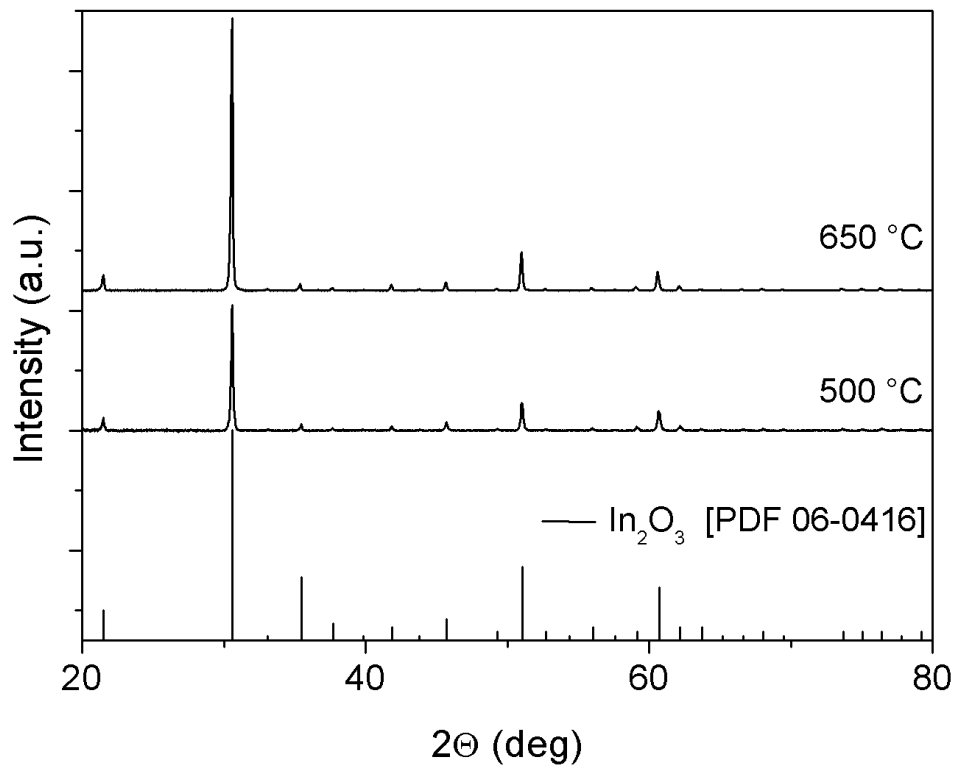

Figure 25: XRD diffractograms of the  $\text{In}_2\text{O}_3$  films.

## 4 SUMMARY

---

This work describes the synthesis and characterisation of a series of 15 novel  $\beta$ -donor functionalised alcohols bearing thioether and amino-moieties. In addition, 30 new metal alkoxide of group 13 elements (gallium and indium) have been prepared and characterised. The synthesis of the alkoxides has been achieved via standard methods, in particular alcohol exchange and amine elimination reactions.

$^1\text{H}$  and  $^{13}\text{C}$  NMR spectra of symmetric dithioethers revealed broadened signals for the groups in direct vicinity to the sulphur donor. These findings, combined with relatively small shifts when compared to the uncoordinated ligand species, indicate weak sulphur-metal interactions concurrent with fluxional coordination behaviour in solution. For asymmetrically substituted alkoxides with amino and thioether donors, a clear indication of an amine coordination to the metal centre has been observed in  $^1\text{H}$  and  $^{13}\text{C}$  NMR spectra. These findings lead to the conclusion that only nitrogen is interacting with the metal centre while the thioether side chain is not involved in additional donor stabilisation of the alkoxide molecule. Single crystal XRD of the symmetric tertiary indium alkoxide **58** reveals a monomeric structure with three sulphurs coordinated to the metal centre leading to an octahedral coordination. These findings are in good agreement with the behaviour shown in NMR experiments and show for the first time that sulphur has the ability to act as a donor in metal alkoxide species.

Investigation of the thermal properties via TGA experiments illustrate that most alkoxides are decomposing in a one- or two-step process at moderate temperatures. Nevertheless, the compounds – especially species bearing two  $^n$ butylthio donors (**34**, **40**, **48** and **57**) – seem to be well suited as precursors in LP-CVD.

Lastly, the use of  $\text{In}(\text{O}^t\text{Bu})_3$  as a reference substance for the deposition of  $\text{In}_2\text{O}_3$  films is described. The formed deposits show good homogeneity and consist of phase pure  $\text{In}_2\text{O}_3$ .

## 5 EXPERIMENTAL

---

### 5.1 General Methods and Materials

---

All manipulations involving alkoxides were carried out in moisture- and oxygen-free atmosphere of dry nitrogen using standard Schlenk or glove box techniques. All glass parts were dried by heating under dynamic vacuum prior to use. Solvents were purified and desiccated by standard methods and stored under nitrogen atmosphere. The solvents for NMR spectroscopy (EurisoTop or Aldrich) were degassed or distilled over Na prior to use and stored over molecular sieve. Chemicals for ligand synthesis and water-free metal chlorides were purchased from Sigma Aldrich, Alfa Aesar, ABCR and Acros organics and used as received.

### 5.2 Analytical Techniques

---

#### 5.2.1 Nuclear Magnetic Resonance Spectroscopy (NMR)

$^1\text{H}$  and  $^{13}\text{C}$  solution NMR spectra were recorded on a Bruker AVANCE 250 spectrometer (250.13 MHz  $\{^1\text{H}\}$ , 62.86 MHz  $\{^{13}\text{C}\}$ ) equipped with a 5 mm inverse-broadband probe head and a  $z$ -gradient unit.

#### 5.2.2 Infrared Spectroscopy (IR)

FT-IR spectra were recorded on a Bruker Tensor 27. Ligands were measured with an ATR MicroFocusing MVP-QL with a diamond crystal using OPUS version 4.0 software for analysis. Resolution was set to  $4\text{ cm}^{-1}$  in a range from  $4000$  to  $600\text{ cm}^{-1}$  recording 32 scans.

#### 5.2.3 Single Crystal X-Ray Diffraction (XRD)

Single crystal X-ray diffraction experiments were performed at 100K on a Bruker-AXS SMART APEX II diffractometer with a CCD area detector and a crystal-to-detector distance of 5.0 cm using graphite-monochromated Mo- $K_\alpha$  radiation ( $\lambda = 71.073\text{ pm}$ ). Data were collected with  $\phi$

and  $\omega$ -scans and  $0.5^\circ$  frame width. The data were corrected for polarisation and Lorentz effects, and an empirical absorption correction (SADABS) was applied. The cell dimensions were refined with all unique reflections. The structures were solved with direct methods (SHELXS97) and refinement to convergence was carried out with the full-matrix least squares method based on  $F^2$  (SHELXL97) with anisotropic structure parameters for all non-hydrogen atoms. The hydrogen atoms were placed on calculated positions and refined riding on their parent atoms.

### 5.2.4 Gas Chromatography-Mass Spectrometry (GC/MS)

GC/MS measurements were conducted on a ThermoFinnigan gas chromatograph equipped with an 8000 top and a BGB5 column ( $l=30$  m,  $d=0.32$  mm,  $1 \mu\text{m}$  film thickness) coupled with a Voyager quadrupole mass spectrometer (electron impact ionisation).

### 5.2.5 Thermogravimetric Analysis (TGA)

Thermogravimetric analyses were performed on a Netzsch Iris TG 209 C with a 414 TASC controller in  $\text{Al}_2\text{O}_3$  crucibles using a heating rate of  $10^\circ\text{C}/\text{min}$  in nitrogen atmosphere. Data processing was achieved using Proteus Analysis software.

## 5.3 Ligand Syntheses

### 1-Chloro-3-isopropylthiopropan-2-ol (1):

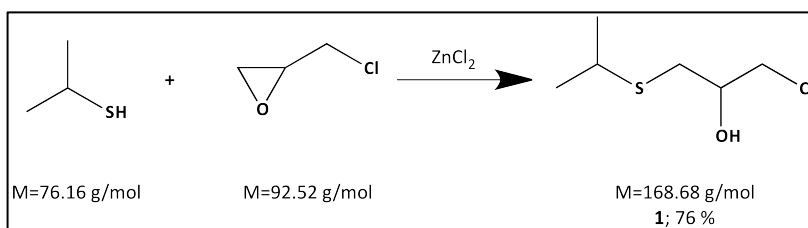

The reaction was carried out similar to a known procedure reported by Todsén *et al.*<sup>[164]</sup> 8.5 g (111 mmol, 1.08 equiv.) isopropanethiol and 9.5 g (103 mmol, 1 equiv.) epichlorohydrin were mixed and 0.2 g  $\text{ZnCl}_2$  were added. The mixture was refluxed for 3 h and then directly purified by distillation using a Vigreux column yielding 13.2 g (78 mmol, 75.7 %) pure **1** at a boiling point of  $82^\circ\text{C}$  (5 mbar).

**$^1\text{H}$  NMR (CDCl<sub>3</sub>, 200 MHz,  $\delta$  [ppm]):** 1.26 (d, J=6.79 Hz, 6H, CH(CH<sub>3</sub>)<sub>2</sub>), 2.67 (dd, J=7.11 / 13.68 Hz, 1H, S-CH<sub>2</sub>-CH), 2.74-2.86 (m, 2H, S-CH<sub>2</sub>-CH, OH), 2.95 (m, J=6.69 Hz, 1H, CH(CH<sub>3</sub>)<sub>2</sub>), 3.66 (dd, J=5.25 / 11.03 Hz, 2H, CH<sub>2</sub>-Cl), 3.90 (quint, J=5.73 Hz, 1H, CH-OH)

**$^{13}\text{C}$  { $^1\text{H}$ } NMR (CDCl<sub>3</sub>, 62.86 MHz,  $\delta$  [ppm]):** 23.29 (s, CH(CH<sub>3</sub>)<sub>2</sub>), 34.61 (s, CH<sub>2</sub>-S), 35.34 (s, CH(CH<sub>3</sub>)<sub>2</sub>), 47.91 (s, CH<sub>2</sub>-Cl), 69.86 (s, CH-OH)

**IR (ATR, cm<sup>-1</sup>):**  $\nu$ = 3411 (br, OH), 2960 (m, CH), 1041 (s, C-OH)

**GC-EIMS (m/z) found (calc.):** 168.00 (168.04) [M]<sup>+</sup>, 123.98 (123.94) [M -<sup>i</sup>PrH]<sup>+</sup>, 89.03 (89.01) [M -<sup>i</sup>PrH-Cl]<sup>+</sup>

## 2-((Isopropylthio)methyl)oxirane (2):

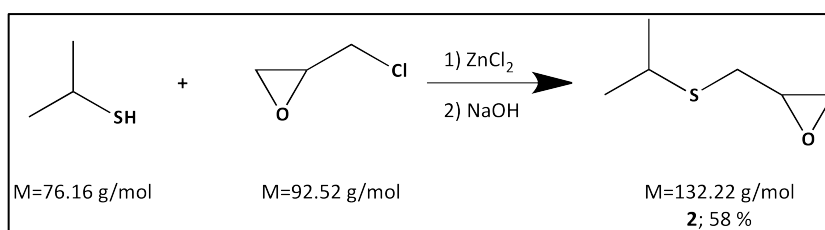

0.2 g ZnCl<sub>2</sub> were added to a mixture of 9.5 g (124 mol, 1.1 equiv) isopropanethiol and 10.5 g (113 mmol, 1 equiv.) epichlorohydrin. After refluxing for 3 h, 50 ml ether and 5 g (125 mmol, 1.1 equiv.) finely ground NaOH were added and further refluxed for 2 h. After cooling, saturated brine was added, phases separated and the water phase extracted four times with 50 ml diethyl ether each. The organic phases were dried over Na<sub>2</sub>SO<sub>4</sub>, filtered and the solvent was removed. Distillation of the crude product yielded 8.6 g (65 mmol, 58 %) pure compound **2** at a boiling point of 54 °C (7 mbar).

**$^1\text{H}$  NMR (CDCl<sub>3</sub>, 200 MHz,  $\delta$  [ppm]):** 1,26 (d, J=6.74 Hz, 6H, CH(CH<sub>3</sub>)<sub>2</sub>), 2.52-2.84 (m, 4H, S-CH<sub>2</sub>-CH, CH<sub>2</sub>-O), 3.02 (m, J=6.67 Hz, 1H, CH(CH<sub>3</sub>)<sub>2</sub>), 3.10 (m, 1H, CH-O)

**$^{13}\text{C}$  { $^1\text{H}$ } NMR (CDCl<sub>3</sub>, 62.86 MHz,  $\delta$  [ppm]):** 23.42 (s, CH(CH<sub>3</sub>)<sub>2</sub>), 32.82 (s, S-CH<sub>2</sub>-CH), 35.15 (s, CH(CH<sub>3</sub>)<sub>2</sub>), 47.11 (s, CH<sub>2</sub>-O), 51.92 (CH-O)

**IR (ATR, cm<sup>-1</sup>):**  $\nu$ = 2961 (s, CH), 827 (s, Epoxide ringmode)

**GC-EIMS (m/z) found (calc.):** 132.01 (132.06) [M]<sup>+</sup>, 89.03 (89.01) [M -<sup>i</sup>C<sub>3</sub>H<sub>7</sub>]<sup>+</sup>, 74.04 (74.15) [CH<sub>3</sub>-C(=S)-CH<sub>3</sub>]<sup>+</sup>

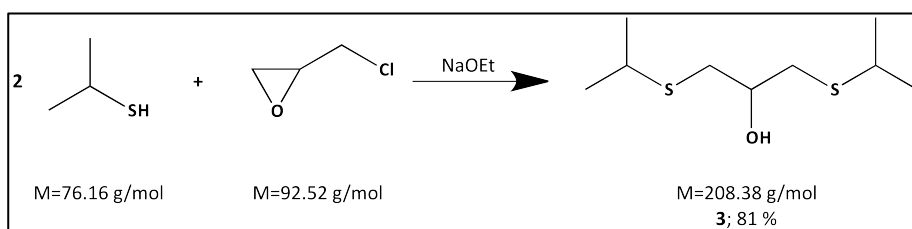
**1,3-Bis(isopropylthio)propan-2-ol (3):**

0.76 g (32 mmol, 2 equiv.) Na were dissolved in 40 ml absolute ethanol and 2.5 g (32 mmol, 2 equiv.) 2-isopropanethiol were added. Subsequently, 1.48 g (16 mmol, 1 equiv.) epichlorohydrin were added and the mixture was refluxed for 6 h. Then, the mixture was diluted with 50 ml of water and the EtOH removed under reduced pressure. The water phase was then extracted five times with 50 ml petrol ether each, the collected organic phases dried over  $\text{Na}_2\text{SO}_4$ , filtered and the solvent was removed. The crude product was distilled to yield 2.74 g (13 mmol, 81 %) of **3** at 114 °C (4 mbar).

$^1\text{H NMR}$  ( $\text{CDCl}_3$ , 200 MHz,  $\delta$  [ppm]): 1.26 (d,  $J=6.77$  Hz, 12H,  $\text{CH}(\text{CH}_3)_2$ ), 2.63 (dd,  $J=7.33 / 13.46$  Hz, 2H,  $\text{S-CH}_2\text{-CH}$ ), 2.78 (dd,  $J=4.94 / 13.46$  Hz, 2H,  $\text{S-CH}_2\text{-CH}$ ), 2.87-3.00 (m, 3H,  $\text{OH}$ ,  $\text{CH}(\text{CH}_3)_2$ )

$^{13}\text{C}$  { $^1\text{H}$ } NMR ( $\text{CDCl}_3$ , 62.86 MHz,  $\delta$  [ppm]): 23.58 (s,  $\text{CH}(\text{CH}_3)_2$ ), 35.52 (s,  $\text{CH}(\text{CH}_3)_2$ ), 36.94 (s,  $\text{S-CH}_2\text{-CH}$ ), 69.28 (s,  $\text{CH-OH}$ )

IR (ATR,  $\text{cm}^{-1}$ ):  $\nu = 3440$  (br, OH), 2956 (s, CH), 1025 (s, C-OH)

GC-EIMS ( $m/z$ ) found (calc.): 208.08 (208.10)  $[\text{M}]^+$ , 165.99 (165.04)  $[\text{M} - ^i\text{C}_3\text{H}_7]^+$ , 122.95 (122.99)  $[\text{M} - 2^i\text{C}_3\text{H}_7]^+$

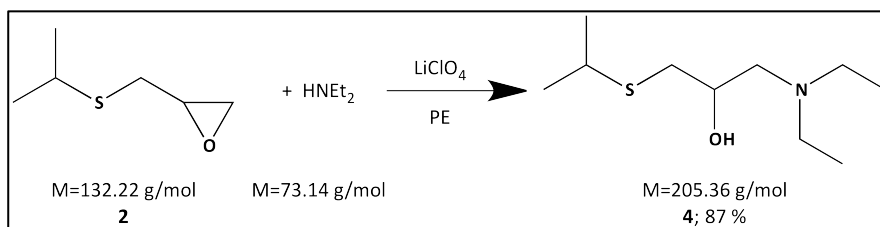
**1-Diethylamino-3-(isopropylthio)propan-2-ol (4):**

3.2 g (24.2 mmol, 1 equiv.) of **2**, 5 ml diethylamine (48 mmol, excess) and 0.25 ml 5 M  $\text{LiClO}_4$  solution in 20 ml petrol ether were refluxed for 12 h. After cooling, approx. 30 ml saturated brine were added, the phases separated and the water phase extracted 4 times with 50 ml



petrol ether. The organic phases were dried over  $\text{Na}_2\text{SO}_4$  and the solvent was removed. The crude product was purified via distillation at  $62\text{ }^\circ\text{C}$  (0.3 mbar) yielding 4.3 g (21 mmol, 87 %) of **4**.

**$^1\text{H}$  NMR ( $\text{CDCl}_3$ , 200 MHz,  $\delta$  [ppm]):** 0.91 (t,  $J=7.11$  Hz, 6H,  $\text{N}(\text{CH}_2\text{CH}_3)_2$ ), 1.17 (dd,  $J=1.57 / 6.76$  Hz, 6H,  $\text{CH}(\text{CH}_3)_3$ ), 2.25-2.71 (m, 8H,  $\text{S}-\text{CH}_2-\text{CH}$ ,  $\text{N}-\text{CH}_2-\text{CH}$ ,  $\text{N}(\text{CH}_2\text{CH}_3)_2$ ), 2.97 (quint, 6.72 Hz, 1H,  $\text{CH}(\text{CH}_3)_3$ ), 3.71 (m, 1H,  $\text{CH}$ ), 3.85 (s, 1H,  $\text{OH}$ )

**$^{13}\text{C}$   $\{^1\text{H}\}$  NMR ( $\text{CDCl}_3$ , 62.86 MHz,  $\delta$  [ppm]):** 12.14 (s,  $\text{N}(\text{CH}_2\text{CH}_3)_2$ ), 23.58 (s,  $\text{CH}(\text{CH}_3)_2$ ), 35.51 (s,  $\text{CH}(\text{CH}_3)_2$ ), 35.71 (s,  $\text{S}-\text{CH}_2-\text{CH}$ ), 47.28 (s,  $\text{N}(\text{CH}_2\text{CH}_3)_2$ ), 58.65 (s,  $\text{N}-\text{CH}_2-\text{CH}$ ), 67.03 (s,  $\text{CH}-\text{OH}$ )

**IR (ATR,  $\text{cm}^{-1}$ ):**  $\nu=3434$  (br, OH), 2963 (s, CH), 1063 (s, C-OH)

**GC-EIMS (m/z) found (calc.):** 162.07 (162.10) [ $\text{M} - \text{C}_3\text{H}_7$ ] $^+$ , 116.12 (116.11) [ $\text{M} - \text{PrSCH}_2$ ] $^+$ , 86.09 (86.06) [ $\text{Et}_2\text{NCH}_2$ ] $^+$

### 1- $n$ Butylthio-3-chloropropan-2-ol (**5**):

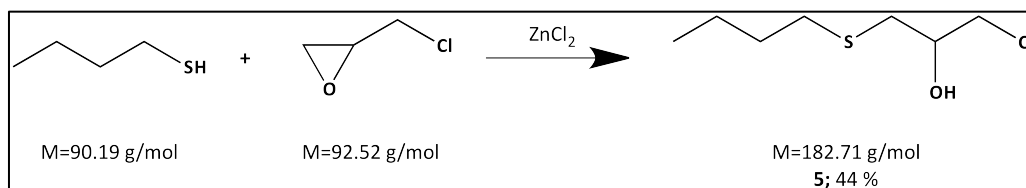

The reaction was conducted following published procedures by Todsén *et al.*<sup>[164]</sup> 40 g (444 mmol, 1.1 equiv.)  $n$ -butanethiol and 37.3 g (403 mmol, 1 equiv.) epichlorohydrin were mixed in a 250 ml flask and cooled to  $0\text{ }^\circ\text{C}$  before adding 0.5 g  $\text{ZnCl}_2$ . After refluxing for 3 h, the mixture was purified via distillation using a Vigreux column to yield 32.08 g (175 mmol, 44 %) of **5** with a boiling point of  $65\text{ }^\circ\text{C}$  (0.1 mbar).

**$^1\text{H}$  NMR ( $\text{CDCl}_3$ , 200 MHz,  $\delta$  [ppm]):** 0.92 (t,  $J=7.28$  Hz, 3H,  $\text{CH}_3$ ), 1.41 (m,  $J=7.34$  Hz, 2H,  $\text{CH}_3-\text{CH}_2$ ), 1.58 (quint,  $J=7.28$  Hz, 2H,  $\text{CH}_2-\text{CH}_2-\text{CH}_2$ ), 2.56 (t,  $J=7.27$  Hz, 2H,  $\text{CH}_2-\text{CH}_2-\text{S}$ ), 2.60-2.85 (m, 3H,  $\text{S}-\text{CH}_2-\text{CH}$ ,  $\text{OH}$ ), 3.66 (d,  $J=4.62$  Hz, 1H,  $\text{CH}_2-\text{Cl}$ ), 3.92 (m, 1H,  $\text{CH}$ )

**$^{13}\text{C}$   $\{^1\text{H}\}$  NMR ( $\text{CDCl}_3$ , 62.86 MHz,  $\delta$  [ppm]):** 13.40 (s,  $\text{CH}_3\text{CH}_2\text{CH}_2$ ), 21.65 (s,  $\text{CH}_3\text{CH}_2\text{CH}_2$ ), 31.48 (s,  $\text{CH}_2\text{CH}_2-\text{S}$ ), 32.08 ( $\text{CH}_2\text{CH}_2-\text{S}$ ), 35.97 (s,  $\text{S}-\text{CH}_2-\text{CH}$ ), 47.77 (s,  $\text{CH}_2-\text{Cl}$ ), 69.77 (s,  $\text{CH}-\text{OH}$ )

**IR (ATR,  $\text{cm}^{-1}$ ):**  $\nu=3414$  (br, OH), 2957 (s, CH), 1041 (s, C-OH)

**GC-EIMS (m/z) found (calc.):** 182.02 (182.05) [ $\text{M}$ ] $^+$ , 133.03 (133.07) [ $\text{M} - \text{CH}_2\text{Cl}$ ] $^+$ , 103.03 (103.06) [ $n\text{BuSCH}_2$ ] $^+$

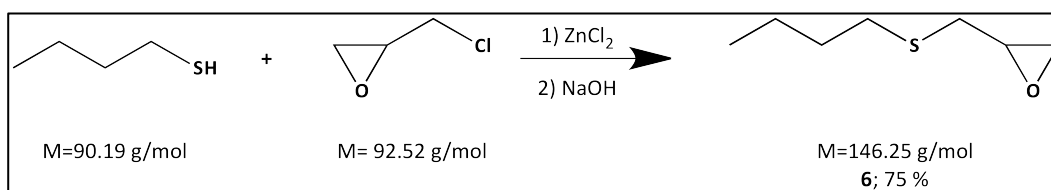
**2-((<sup>n</sup>Butylthio)methyl)oxirane (6):**

0.2 g ZnCl<sub>2</sub> and 20 ml petrol ether were added to a mixture containing 11 g (119 mmol, 1 equiv.) <sup>n</sup>butanethiol and 11.25 g (121 mmol, 1 equiv.) epichlorohydrin and refluxed for 3 h. The solvent was removed and 50 ml diethyl ether as well as 4 g (100 mmol, 0.83 equiv.) finely ground NaOH were subsequently added. After refluxing for 2 h, 75 ml of saturated brine were added and the mixture extracted four times with petrol ether. The collected organic phases were dried over Na<sub>2</sub>SO<sub>4</sub>, filtered and the solvent removed. Distillation at 70 °C under reduced pressure (6 mbar) yielded 13.2 g (90 mmol, 75 %) of **6** as a clear, colourless liquid.

<sup>1</sup>H NMR (CDCl<sub>3</sub>, 200 MHz, δ [ppm]): 0.89 (t, J=7.32 Hz, 3H, CH<sub>3</sub>CH<sub>2</sub>CH<sub>2</sub>), 1.38 (m, J=7.06 Hz, 2H, CH<sub>3</sub>CH<sub>2</sub>CH<sub>2</sub>), 1.55 (quint, J=7.12 Hz, 2H, CH<sub>2</sub>CH<sub>2</sub>-S), 2.50-2.83 (m, 6H, CH<sub>2</sub>CH<sub>2</sub>-S, S-CH<sub>2</sub>-CH, CH<sub>2</sub>-O), 3.10 (m, 1H, CH-O)

<sup>13</sup>C {<sup>1</sup>H} NMR (CDCl<sub>3</sub>, 62.86 MHz, δ [ppm]): 13.70 (s, CH<sub>3</sub>CH<sub>2</sub>CH<sub>2</sub>), 21.97 (s, CH<sub>3</sub>CH<sub>2</sub>CH<sub>2</sub>), 31.81 (s, CH<sub>2</sub>CH<sub>2</sub>-S), 32.21 (s, CH<sub>2</sub>CH<sub>2</sub>-S), 34.31 (s, S-CH<sub>2</sub>-CH), 46.97 (s, CH<sub>2</sub>-O), 51.96 (s, CH-O)

IR (ATR, cm<sup>-1</sup>): ν = 2957 (s, CH), 826 (s, Epoxide ringmode)

GC-EIMS (m/z) found (calc.): 146.02 (146.07) [M]<sup>+</sup>, 103.05 (103.06) [<sup>n</sup>BuSCH<sub>2</sub>]<sup>+</sup>, 61.03 (61.01) [EtS]<sup>+</sup>

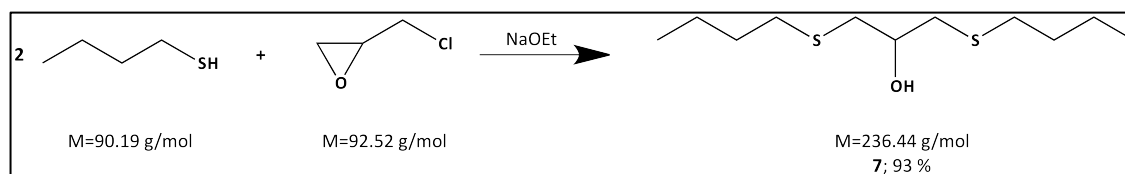
**1,3-Bis((<sup>n</sup>butylthio)propan-2-ol (7):**

The reaction was conducted identically to the isopropyl-analogue (**3**) described before using 5 g (55 mmol, 2.1 equiv.) <sup>n</sup>butanethiol, 1.2 g (52 mmol, 2 equiv.) Na and 2.5 g (27 mmol,

1 equiv.) epichlorohydrin. Refluxing for 2 h and subsequent distillation yielded 6.01 g (25 mmol, 93 %) of **7** as a clear, colourless liquid with a boiling point of 144 °C (4 mbar).

**<sup>1</sup>H NMR (CDCl<sub>3</sub>, 200 MHz, δ [ppm]):** 0.90 (t, J=7.24 Hz, 6H, CH<sub>3</sub>CH<sub>2</sub>CH<sub>2</sub>), 1.39 (m, J=7.42 Hz, 4H, CH<sub>3</sub>CH<sub>2</sub>CH<sub>2</sub>), 1.56 (quint, J=7.26 Hz, 4H, CH<sub>2</sub>CH<sub>2</sub>-S), 2.54 (t, J=7.08 Hz, 4H, CH<sub>2</sub>CH<sub>2</sub>-S), 2.60 (dd, J=7.47 / 13.49 Hz, 2H, S-CH<sub>2</sub>-CH), 2.75 (dd, J=4.75 / 13.49 Hz, 2H, S-CH<sub>2</sub>-CH), 2.91 (d, J=3.02 Hz, 1H, OH), 3.78 (m, 1H, CH)

**<sup>13</sup>C {<sup>1</sup>H} NMR (CDCl<sub>3</sub>, 62.86 MHz, δ [ppm]):** 13.50 (s, CH<sub>3</sub>CH<sub>2</sub>CH<sub>2</sub>), 21.77 (s, CH<sub>3</sub>CH<sub>2</sub>CH<sub>2</sub>), 31.66 (s, CH<sub>2</sub>CH<sub>2</sub>-S), 32.21 (s, CH<sub>2</sub>CH<sub>2</sub>-S), 38.23 (s, S-CH<sub>2</sub>-CH), 68.65 (s, CH-OH)

**IR (ATR, cm<sup>-1</sup>):** ν= 3437 (br, OH), 2966 (s, CH), 1026 (s, C-OH)

**GC-EIMS (m/z) found (calc.):** 236.08 (236.13) [M]<sup>+</sup>, 218.09 (218.12) [M -H<sub>2</sub>O]<sup>+</sup>, 179.02 (179.06) [M -C<sub>4</sub>H<sub>9</sub>]<sup>+</sup>

### 1-<sup>n</sup>Butylthio-3-(diethylamino)propan-2-ol (**8**):

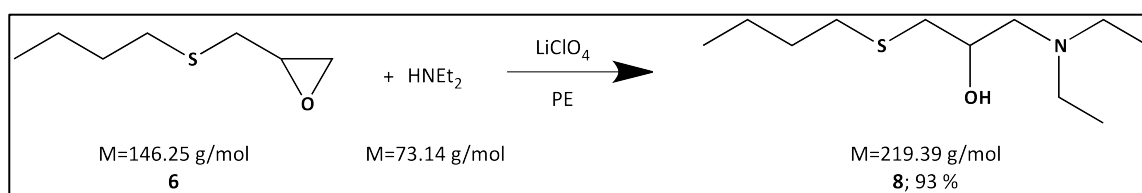

4 g (27 mmol, 1 equiv.) of **6**, 6 ml diethylamine (57 mmol, excess) and 0.3 ml 5 M LiClO<sub>4</sub> solution in 20 ml petrol ether were refluxed for 12 h. After cooling, approx. 30 ml saturated brine were added, the phases separated and the water phase extracted 4 times with 50 ml petrol ether each. The organic phases were dried over Na<sub>2</sub>SO<sub>4</sub> and the solvent was removed. The crude product was purified via distillation at 113 °C (5 mbar) yielding 5.5 g (25 mmol, 93 %) of **8**.

**<sup>1</sup>H NMR (CDCl<sub>3</sub>, 200 MHz, δ [ppm]):** 0.89 (t, J=7.13 Hz, 3H, CH<sub>3</sub>CH<sub>2</sub>CH<sub>2</sub>), 1.00 (t, J=7.12 Hz, 6H, N(CH<sub>2</sub>CH<sub>3</sub>)<sub>2</sub>), 1.38 (m, J=7.14 Hz, 2H, CH<sub>3</sub>CH<sub>2</sub>CH<sub>2</sub>), 1.56 (quint, J=7.34 Hz, 2H, CH<sub>2</sub>CH<sub>2</sub>-S), 2.25-2.70 (m, 10H, CH<sub>2</sub>CH<sub>2</sub>-S, S-CH<sub>2</sub>-CH, N-CH<sub>2</sub>-CH, N(CH<sub>2</sub>CH<sub>3</sub>)<sub>2</sub>), 3.71 (m, 1H, CH), 3.84 (s, 1H, OH)

**<sup>13</sup>C {<sup>1</sup>H} NMR (CDCl<sub>3</sub>, 62.86 MHz, δ [ppm]):** 11.98 (s, N(CH<sub>2</sub>CH<sub>3</sub>)<sub>2</sub>), 13.64 (s, CH<sub>3</sub>CH<sub>2</sub>CH<sub>2</sub>), 21.92 (s, CH<sub>3</sub>CH<sub>2</sub>CH<sub>2</sub>), 31.80 (s, CH<sub>2</sub>CH<sub>2</sub>-S), 32.72 (s, CH<sub>2</sub>CH<sub>2</sub>-S), 37.01 (s, S-CH<sub>2</sub>-CH), 47.14 (s, N(CH<sub>2</sub>CH<sub>3</sub>)<sub>2</sub>), 58.44 (s, CH-CH<sub>2</sub>-N), 66.84 (s, CH-OH)

**IR (ATR, cm<sup>-1</sup>):** ν= 3436 (br, OH), 2963 (s, CH), 1063 (s, C-OH)

**GC-EIMS (m/z) found (calc.):** 116.03 (116.11) [M -<sup>n</sup>BuSCH<sub>2</sub>]<sup>+</sup>, 86.06 (86.06) [Et<sub>2</sub>NCH<sub>2</sub>]<sup>+</sup>

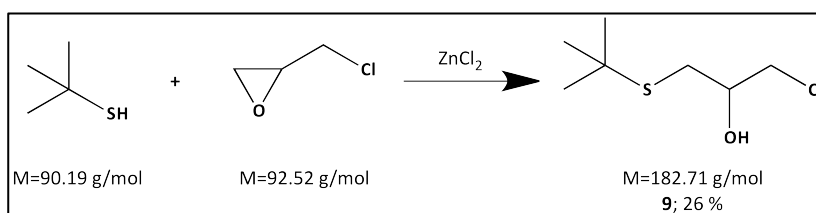
**1-<sup>t</sup>Butylthio-3-chloropropan-2-ol (9):**

20 g (222 mmol, 1.1 equiv.) <sup>t</sup>butanethiol and 18.5 g (200 mmol, 1 equiv.) epichlorohydrin were mixed, 0.5 g ZnCl<sub>2</sub> added and the mixture refluxed for 12 h. After cooling, 1 M H<sub>2</sub>SO<sub>4</sub> was added and the phases separated with diethyl ether. After drying over Na<sub>2</sub>SO<sub>4</sub> and removal of the solvent, the crude product was purified via distillation using a Vigreux column yielding 9.6 g (52.5 mmol, 26.3 %) pure compound **9** at a boiling point of 90 °C (5 mbar).

<sup>1</sup>H NMR (CDCl<sub>3</sub>, 200 MHz, δ [ppm]): 1.33 (s, 9H, C(CH<sub>3</sub>)<sub>3</sub>), 2.61 (s, 1H, OH), 2.72 (dd, J=6.88 / 13.03 Hz, 1H, S-CH<sub>2</sub>-CH), 2.81 (dd, J=5.69 / 13.03 Hz, 1H, S-CH<sub>2</sub>-CH), 3.57-3.70 (m, 2H, CH<sub>2</sub>-Cl), 3.91 (m, J=5.67 Hz, 1H, CH)

<sup>13</sup>C {<sup>1</sup>H} NMR (CDCl<sub>3</sub>, 62.86 MHz, δ [ppm]): 31.12 (s, C(CH<sub>3</sub>)<sub>3</sub>), 32.93 (s, S-CH<sub>2</sub>-CH), 42.87 (s, C(CH<sub>3</sub>)<sub>3</sub>), 48.36 (s, CH<sub>2</sub>-Cl), 70.43 (CH-OH)

IR (ATR, cm<sup>-1</sup>): ν = 3407 (br, OH), 2961 (s, CH), 1043 (s, C-OH)

GC-EIMS (m/z) found (calc.): 182.01 (182.05) [M]<sup>+</sup>, 107.98 (107.98) [M -<sup>t</sup>BuOH]<sup>+</sup>, 57.08 (57.07) [<sup>t</sup>C<sub>4</sub>H<sub>9</sub>]<sup>+</sup>

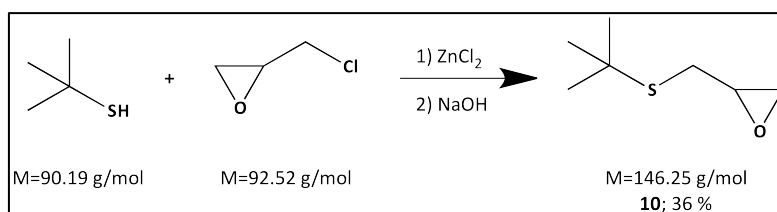
**2-((<sup>t</sup>Butylthio)methyl)oxirane (10):**

0.3 g ZnCl<sub>2</sub> were added to a solution of 8 g (89 mmol, 1.04 equiv.) <sup>t</sup>butanethiol and 8 g (86 mmol, 1equiv.) epichlorohydrin in 20 ml petrol ether and the reaction mixture refluxed for 12 h. 2 M HCl was then added until the formed precipitate was dissolved, the phases separated and the water phase further extracted four times with 50 ml of petrol ether each. After removal of the solvent, 4 g (100 mmol, 1.1 equiv.) NaOH and diethyl ether were added

and the suspension refluxed for 1 h. After cooling, saturated brine was added, phases separated and the water phase extracted four times with petrol ether. After drying over  $\text{Na}_2\text{SO}_4$  and removal of the solvent, the crude product was purified via at 50 °C (7 mbar) to yield 4.5 g (31 mmol, 36 %) of **10** as a clear, colourless liquid.

$^1\text{H}$  NMR ( $\text{CDCl}_3$ , 200 MHz,  $\delta$  [ppm]): 1.32 (s, 9H,  $\text{C}(\underline{\text{C}}\text{H}_3)_3$ ), 2.48-2.60 (m, 2H,  $\text{S}-\underline{\text{C}}\text{H}_2-\text{CH}$ ), 2.74-2.86 (m, 2H,  $\underline{\text{C}}\text{H}_2-\text{O}$ ), 3.07 (m, 1H,  $\underline{\text{C}}\text{H}-\text{O}$ )

$^{13}\text{C}$   $\{^1\text{H}\}$  NMR ( $\text{CDCl}_3$ , 62.86 MHz,  $\delta$  [ppm]): 30.88 (s,  $\text{C}(\underline{\text{C}}\text{H}_3)_3$ ), 31.08 (s,  $\text{S}-\underline{\text{C}}\text{H}_2$ ), 42.15 (s,  $\underline{\text{C}}(\text{C}\text{H}_3)_3$ ), 47.62 (s,  $\underline{\text{C}}\text{H}_2-\text{O}$ ), 51.61 (s,  $\underline{\text{C}}\text{H}-\text{O}$ )

IR (ATR,  $\text{cm}^{-1}$ ):  $\nu = 2962$  (s, CH), 835 (s, Epoxide ringmode)

GC-EIMS (m/z) found (calc.): 146.04 (146.08)  $[\text{M}]^+$ , 90.05 (90.05)  $[\text{tBuSH}]^+$ , 57.08 (57.07)  $[\text{tC}_4\text{H}_9]^+$

### 1,3-Bis(<sup>t</sup>butylthio)propan-2-ol (**11**):

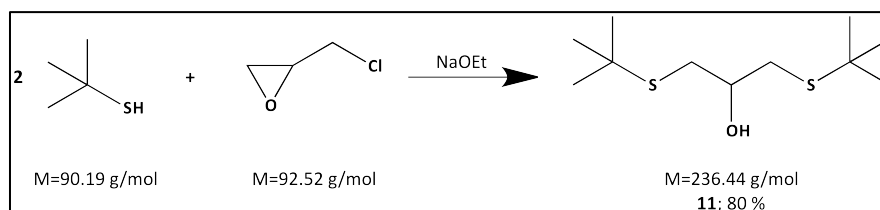

The reaction was carried out similar to the isopropyl and <sup>n</sup>butyl-analogues (**3/7**) using 2.39 g (32 mmol, 2 equiv.) <sup>t</sup>butanethiol, 0.75 g (32 mmol, 2 equiv.) Na and 1.5 g (16 mmol, 1 equiv.) epichlorohydrin. The reaction was refluxed for 6 h before processing and yielded 3.03 g (13 mmol, 80 %) of **11** with a boiling point of 82 °C (0.3 mbar).

$^1\text{H}$  NMR ( $\text{CDCl}_3$ , 200 MHz,  $\delta$  [ppm]): 1.32 (s, 18H,  $\text{C}(\underline{\text{C}}\text{H}_3)_3$ ), 2.66 (dd,  $J = 7.11/12.77$  Hz, 2H,  $\text{S}-\underline{\text{C}}\text{H}_2-\text{CH}$ ), 2.75-2.83 (m, 3H,  $\text{S}-\underline{\text{C}}\text{H}_2-\text{CH}$ ,  $\underline{\text{C}}\text{H}-\text{OH}$ ), 3.78 (m, 1H,  $\underline{\text{C}}\text{H}$ )

$^{13}\text{C}$   $\{^1\text{H}\}$  NMR ( $\text{CDCl}_3$ , 62.86 MHz,  $\delta$  [ppm]): 31.19 (s,  $\text{C}(\underline{\text{C}}\text{H}_3)_3$ ), 35.22 (s,  $\underline{\text{C}}\text{H}_2-\text{S}$ ), 42.64 (s,  $\underline{\text{C}}(\text{C}\text{H}_3)_3$ ), 69.91 ( $\underline{\text{C}}\text{H}-\text{OH}$ )

IR (ATR,  $\text{cm}^{-1}$ ):  $\nu = 3435$  (br, OH), 2960 (s, CH), 1031 (s, C-OH)

GC-EIMS (m/z) found (calc.): 179.02 (179.06)  $[\text{M}-\text{tC}_4\text{H}_9]^+$ , 122.92 (122.99)  $[\text{M}-\text{tC}_4\text{H}_9-\text{C}_4\text{H}_8]^+$ , 57.04 (57.08)  $[\text{tC}_4\text{H}_9]^+$

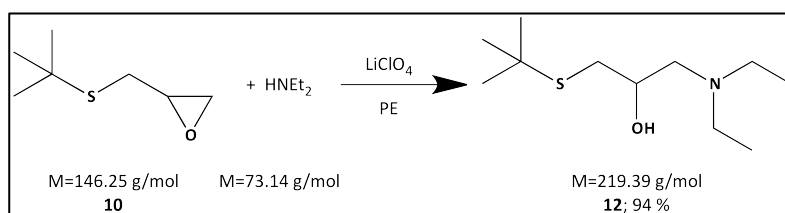
**1-<sup>t</sup>Butylthio-3-(diethylamino)propan-2-ol (12):**

The compound was synthesised similar to the <sup>n</sup>butyl-analogue (**8**) using 4 g (27 mmol, 1 equiv.) of **10**, 6 ml diethylamine (57 mmol, excess), 0.3 ml 5 M LiClO<sub>4</sub> solution and 20 ml petrol ether yielding 5.66 g (25.8 mmol, 94 %) pure **12** at a boiling point of 98 °C (5 mbar).

**<sup>1</sup>H NMR (CDCl<sub>3</sub>, 200 MHz, δ [ppm]):** 0.99 (t, J=7.12 Hz, 6H, N(CH<sub>2</sub>CH<sub>3</sub>)<sub>2</sub>), 1.31 (s, 9H, C(CH<sub>3</sub>)<sub>3</sub>), 2.23-2.76 (m, 8H, N(CH<sub>2</sub>CH<sub>3</sub>)<sub>2</sub>, S-CH<sub>2</sub>-CH, N-CH<sub>2</sub>-CH), 3.70 (m, 1H, CH), 3.88 (s, 1H, OH)

**<sup>13</sup>C {<sup>1</sup>H} NMR (CDCl<sub>3</sub>, 62.86 MHz, δ [ppm]):** 12.13 (s, N(CH<sub>2</sub>CH<sub>3</sub>)<sub>2</sub>), 31.02 (s, C(CH<sub>3</sub>)<sub>2</sub>), 33.36 (s, S-CH<sub>2</sub>-CH), 42.14 (s, C(CH<sub>3</sub>)<sub>3</sub>), 47.14 (s, N(CH<sub>2</sub>CH<sub>3</sub>)<sub>2</sub>), 58.81 (s, N-CH<sub>2</sub>-CH), 68.88 (s, CH-OH)

**IR (ATR, cm<sup>-1</sup>):** ν = 3433 (br, OH), 2967 (s, CH), 1060 (s, C-OH)

**GC-EIMS (m/z) found (calc.):** 162.05 (162.95) [M -<sup>t</sup>C<sub>4</sub>H<sub>9</sub>]<sup>+</sup>, 116.11 (116.11) [M -<sup>t</sup>BuSCH<sub>2</sub>]<sup>+</sup>, 86.07 (86.06) [Et<sub>2</sub>NCH<sub>2</sub>]<sup>+</sup>

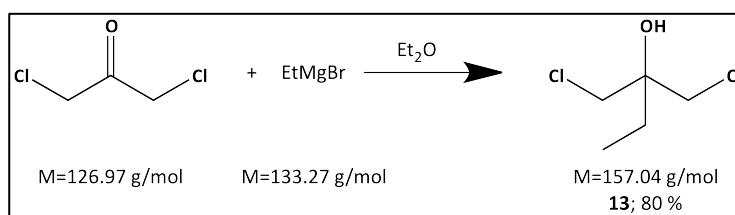
**1-Chloro-2-(chloromethyl)butan-2-ol (13):**

The synthesis was carried out following procedures described by Tanyeli *et al.*<sup>[175]</sup> 12.44 g (511.9 mmol, 1 equiv.) Mg turnings were covered with dry ether and ethylbromide (55.79 g, 511.9 mmol, 1 equiv) was added drop wise until the reaction started. The remaining ethylbromide was diluted with approximately 60 ml dry ether and added at a rate of about 2 drops per second. After the addition of the ethylbromide, the reaction mixture was refluxed for 3 h until all the Mg was dissolved. Then, 65 g 1,3-dichloroacetone (511.9 mmol, 1 equiv.) in 300 ml of dry ether were slowly added at 0 °C yielding a heterogenic brownish reaction mixture. After adding the ketone, the mixture was further refluxed for 2.5 h and

subsequently hydrolysed with saturated  $\text{NH}_4\text{Cl}$  solution and 1 N hydrochloric acid. Phases were separated and the water phase extracted twice with 75 ml of ether each. The collected organic phases were washed with saturated brine, dried over  $\text{Na}_2\text{SO}_4$ , filtered and the solvent removed to yield a red-brown clear liquid. Fractionated distillation at  $74^\circ\text{C}$  (20 mbar) yielded 64.2 g (408.8 mmol, 79.9 %) of **13** as colourless liquid.

$^1\text{H}$  NMR ( $\text{CDCl}_3$ , 200 MHz,  $\delta$  [ppm]): 0.99 (t,  $J=7.64$  Hz, 3H,  $\text{CH}_3$ ), 1.71 (q,  $J=7.52$  Hz, 2H,  $\text{CH}_2\text{CH}_3$ ), 2.27 (s, 1H, OH), 3.62 (q,  $J=11.40$  Hz, 4H,  $\text{CH}_2\text{-Cl}$ )

$^{13}\text{C}$  { $^1\text{H}$ } NMR ( $\text{CDCl}_3$ , 62.86 MHz,  $\delta$  [ppm]): 7.23 (s,  $\text{CH}_3$ ), 27.87 (s,  $\text{CH}_2\text{CH}_3$ ), 48.18 (s,  $\text{CH}_2\text{-Cl}$ ), 73.96 (s,  $\text{C-OH}$ )

IR (ATR,  $\text{cm}^{-1}$ ):  $\nu=3455$  (br, OH), 2971 (m, CH), 1741 (m, OH), 739 (m, C-Cl)

GC-EIMS (m/z) found (calc.): 126.98 (126.97) [ $\text{M}-\text{C}_2\text{H}_5$ ] $^+$ , 107.01 (107.03) [ $\text{M}-\text{CH}_2\text{Cl}$ ] $^+$ , 91.01 (91.00) [ $\text{M}-\text{HCl}-\text{C}_2\text{H}_5$ ] $^+$

### 2-Chloromethyl-2-ethyloxirane (14):

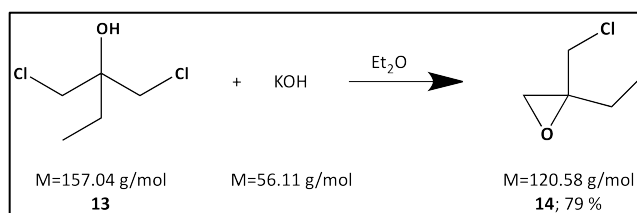

The ring closing reaction was based on a well-established procedure, which was described for example by Guseinova *et al.*<sup>[176]</sup> This step is similar to the ring closing for secondary alcohols described above. 64.32 g (408.8 mmol, 1 equiv.) of **13** were dissolved in 250 ml of dry ether and 45.88 g (817.6 mmol, 2 equiv.) finely ground potassium hydroxide were added in portions. The solution turned lightly yellow and started to boil vigorously, the solid turned to a brown colour. After 2 h of refluxing, the ether solution was filtered off and the solid residue washed thrice with 40 ml of dry ether each. Removal of the ether followed by fractionated distillation at  $52\text{-}53^\circ\text{C}$  (35 mbar) yielded 38.9 g (322.6 mmol, 78.9 %) of **14** as a clear liquid.

$^1\text{H}$  NMR ( $\text{CDCl}_3$ , 200 MHz,  $\delta$  [ppm]): 0.97 (t,  $J=7.51$  Hz, 3H,  $\text{CH}_3$ ), 1.82 (m, 2H,  $\text{CH}_2\text{CH}_3$ ), 2.77 (s, 2H,  $\text{CH}_2\text{-O}$ ), 3.56 (q,  $J=11.57$  Hz, 2H,  $\text{CH}_2\text{-Cl}$ )

$^{13}\text{C} \{^1\text{H}\}$  NMR ( $\text{CDCl}_3$ , 62.86 MHz,  $\delta$  [ppm]): 8.62 (s,  $\text{CH}_3$ ), 24.50 (s,  $\text{CH}_2\text{CH}_3$ ), 47.59 (s,  $\text{CH}_2\text{-Cl}$ ), 52.31 (s,  $\text{CH}_2\text{-O}$ ), 59.43 (s,  $\text{CH}_2\text{-C-O}$ )

IR (ATR,  $\text{cm}^{-1}$ ):  $\nu = 2972$  (m, CH), 734 (s, C-Cl)

GC-EIMS (m/z) found (calc.): 85.09 (85.06)  $[\text{M}-\text{Cl}]^+$ , 71.02 (71.05)  $[\text{M}-\text{CH}_2\text{Cl}]^+$ , 55.10 (55.02)  $[\text{M}-\text{HCl}-\text{C}_2\text{H}_5]^+$

### 1-Ethoxy-2-((ethyloxy)methyl)butan-2-ol (15):

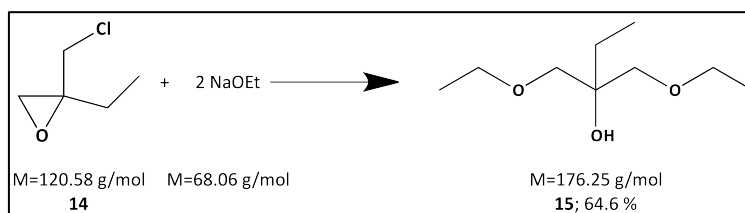

0.763 g (33.2 mmol, 2 equiv.) Na were dissolved in ca. 40 ml absolute EtOH. Then, 2 g (16.6 mmol, 1 equiv.) of **14** were added and the reaction stirred at 45 °C over night. The mixture was then hydrolysed with 30 ml of water, neutralised with 0.5 N HCl and extracted thrice with  $\text{CHCl}_3$ , dried over  $\text{Na}_2\text{SO}_4$ , filtered and the solvents removed under reduced pressure. Finally, the liquid product was then distilled to yield 1.89 g (10.7 mmol, 64.6 %) of pure **15** as a clear, colourless liquid at 55 °C (5 mbar).

$^1\text{H}$  NMR ( $\text{CDCl}_3$ , 200 MHz,  $\delta$  [ppm]): 0.91 (t,  $J=7.54$  Hz, 3H, C- $\text{CH}_2\text{CH}_3$ ), 1.18 (t,  $J=7.01$  Hz, 6H, O- $\text{CH}_2\text{CH}_3$ ), 1.55 (q,  $J=7.54$  Hz, 2H, C- $\text{CH}_2\text{CH}_3$ ), 2.46 (s, 1H, OH), 3.34 (q,  $J=10.05$  Hz, 4H, O- $\text{CH}_2\text{-C}$ ), 3.51 (q,  $J=6.98$  Hz, 4H, O- $\text{CH}_2\text{CH}_3$ )

$^{13}\text{C} \{^1\text{H}\}$  NMR ( $\text{CDCl}_3$ , 62.86 MHz,  $\delta$  [ppm]): 7.46 (s, C- $\text{CH}_2\text{CH}_3$ ), 15.24 (s, O- $\text{CH}_2\text{CH}_3$ ), 27.45 (s, C- $\text{CH}_2\text{CH}_3$ ), 67.00 (O- $\text{CH}_2\text{CH}_3$ ), 73.05 (s, O- $\text{CH}_2\text{-C}$ ), 73.50 (s, C-OH)

IR (ATR,  $\text{cm}^{-1}$ ):  $\nu = 3476$  (br, OH), 2975 (m, CH), 1106 (s, COC)

GC-EIMS (m/z) found (calc.): 117.09 (117.09)  $[\text{M}-\text{EtOCH}_2]^+$ , 89.02 (89.06)  $[\text{M}-\text{EtOCH}_2-\text{C}_2\text{H}_4]^+$ , 71.07 (71.05)  $[\text{M}-\text{EtOCH}_2-\text{EtOH}]^+$



**1-Ethylthio-2-((ethylthio)methyl)butan-2-ol (16),**

**and**

**2-Ethyl-2-(ethylthio)methyl)oxirane (17):**

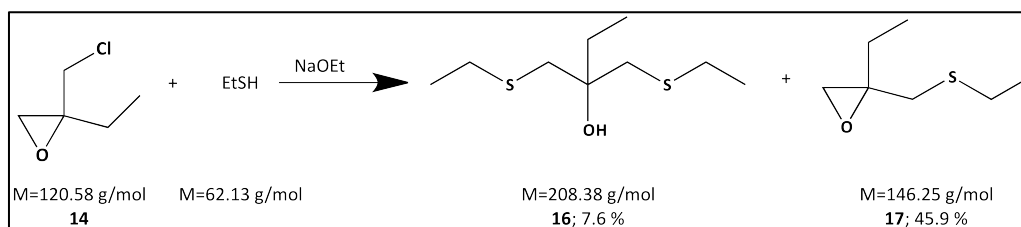

1.03 g (44.74 mmol, 1 equiv.) Na were dissolved in approximately 50 ml absolute ethanol and 2.78 g (44.74 mmol, 1 equiv.) ethanethiol were added via a syringe to form the thiolate in-situ. After a few minutes, 5.40 g (44.74 mmol, 1 equiv.) of **14** were added to the solution at room temperature. During the addition a colourless, finely dispersed precipitate formed immediately and the reaction temperature rose. After stirring over night at room temperature, water was added and the solution neutralised with 0.5 N HCl to a pH of approximately 7. The solution was then extracted thrice with chloroform, dried over  $\text{Na}_2\text{SO}_4$ , filtered and the solvents removed under reduced pressure. The resulting crude product was a mixture, which was separated using column chromatography with  $\text{SiO}_2$  as the solid phase and petrol ether:ethyl acetate = 20:1 as the eluent. Since the purification of **16** by LC had proven to be insufficient, the fraction of the LC was further distilled under reduced pressure to yield 0.71 g (3.4 mmol, 7.6 %) of **16** at 70 °C (0.47 mbar) and 3.0 g (20.5 mmol, 45.9 %) of compound **17**.

**Compound 16:**

$^1\text{H NMR}$  ( $\text{CDCl}_3$ , 200 MHz,  $\delta$  [ppm]): 0.90 (t,  $J=7.46 \text{ Hz}$ , 3H, C- $\text{CH}_2\text{CH}_3$ ), 1.24 (t,  $J=7.27 \text{ Hz}$ , 6H, S- $\text{CH}_2\text{CH}_3$ ), 1.61 (q,  $J=7.45 \text{ Hz}$ , 2H, C- $\text{CH}_2\text{CH}_3$ ), 2.28 (s, br., 1H, OH), 2.57 (q,  $J=7.37 \text{ Hz}$ , 4H, S- $\text{CH}_2\text{CH}_3$ ), 2.65 (d,  $J=13.12 \text{ Hz}$ , 2H, S- $\text{CH}_2\text{-C}$ ), 2.79 (d,  $J=13.12 \text{ Hz}$ , 2H, S- $\text{CH}_2\text{-C}$ )

$^{13}\text{C}$   $\{^1\text{H}\}$  NMR ( $\text{CDCl}_3$ , 62.86 MHz,  $\delta$  [ppm]): 8.01 (s, C- $\text{CH}_2\text{CH}_3$ ), 15.12 (s, S- $\text{CH}_2\text{CH}_3$ ), 28.07 (s, S- $\text{CH}_2\text{CH}_3$ ), 31.24 (s, C- $\text{CH}_2\text{CH}_3$ ), 41.01 (s, C- $\text{CH}_2\text{-S}$ ), 74.31 (C-OH)

IR (ATR,  $\text{cm}^{-1}$ ):  $\nu= 3462$  (br, OH), 2965 (s, CH), 1266 (m, OH)

GC-EIMS (m/z) found (calc.): 208.06 (208.09)  $[\text{M}]^+$ , 133.07 (133.07)  $[\text{M} - \text{EtSCH}_2]^+$ , 71.01 (71.05)  $[\text{M} - \text{EtSCH}_2 - \text{EtSH}]^+$

**Compound 17:**

$^1\text{H NMR}$  ( $\text{CDCl}_3$ , 200 MHz,  $\delta$  [ppm]): 0.93 (t,  $J=7.52$  Hz, 3H, C- $\text{CH}_2\text{CH}_3$ ), 1.25 (t,  $J=7.36$  Hz, 6H, S- $\text{CH}_2\text{CH}_3$ ), 1.79 (m,  $J=7.47$  Hz, 2H, C- $\text{CH}_2\text{CH}_3$ ), 2.51-2.80 (m, 6H,  $\text{CH}_2\text{-O}$ , C- $\text{CH}_2\text{-S}$ , S- $\text{CH}_2\text{CH}_3$ )

$^{13}\text{C}$   $\{^1\text{H}\}$  NMR ( $\text{CDCl}_3$ , 62.86 MHz,  $\delta$  [ppm]): 8.87 (s,  $\text{CH}_3\text{-CH}_2\text{-C}$ ), 14.79 (s,  $\text{CH}_3\text{-CH}_2\text{-S}$ ), 26.01 ( $\text{CH}_3\text{-CH}_2\text{-S}$ ), 26.86 (s, C- $\text{CH}_2\text{-CH}_3$ ), 36.36 (s, C- $\text{CH}_2\text{-S}$ ), 51.83 (s,  $\text{CH}_2\text{-O}$ ), 59.75 (s,  $\text{CH}_2\text{-C-O}$ )

IR (ATR,  $\text{cm}^{-1}$ ):  $\nu = 2968$  (s, CH), 747 (m, Epoxide ringmode)

GC-EIMS ( $m/z$ ) found (calc.): 146.08 (146.08)  $[\text{M}]^+$ , 85.09 (85.07)  $[\text{M} - \text{EtS}]^+$ , 75.00 (75.03)  $[\text{EtSCH}_2]^+$

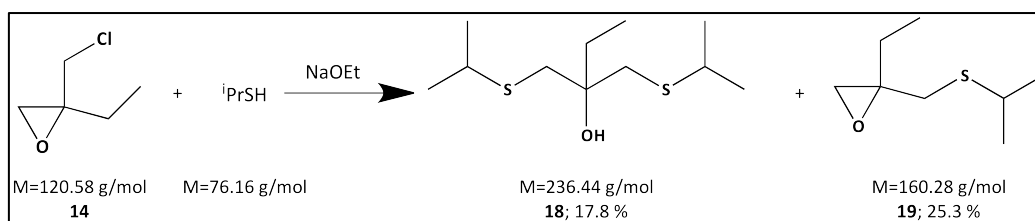
**1-Isopropylthio-2((isopropylthio)methyl)butan-2-ol (18),****and****2-Ethyl-2-(isopropylthio)methyl)oxirane (19):**

1.51 g (65.6 mmol, 1equiv.) Na were dissolved in ca. 50 ml of dry ethanol and 5.0 g (65.6 mmol, 1 equiv.) isopropanethiol were added. In the next step, 7.92 g (65.6 mmol, 1 equiv.) of **14** were added to the solution, stirred for 1 h at room temperature and further refluxed for 2 h. After cooling to room temperature, water was added, the reaction mixture neutralised with 0.5N HCl and extracted three times with chloroform. The organic phases were washed with saturated brine, dried over  $\text{Na}_2\text{SO}_4$ , filtered and the organic solvent was removed. The crude product was purified by column chromatography using petrol ether:ethyl acetate = 7:1 as the eluent. 1.87 g (7.9 mmol, 17.8 %) of the liquid **18** and 2.66 g (16.6 mmol, 25.3 %) of **19** could be isolated by this procedure.

**Compound 18:**

$^1\text{H NMR}$  ( $\text{CDCl}_3$ , 200 MHz,  $\delta$  [ppm]): 0.92 (t,  $J=7.54$  Hz, 3H, C- $\text{CH}_2\text{CH}_3$ ), 1.27 (d,  $J=7.08$  Hz, 12H, C( $\text{CH}_3$ ) $_2$ ), 1.62 (q,  $J=7.47$  Hz, 2H, C- $\text{CH}_2\text{CH}_3$ ), 2.32 (s, br., 1H, OH), 2.66 (d,  $J=12.84$  Hz, 2H, S- $\text{CH}_2\text{-C}$ ), 2.81 (d,  $J=12.84$  Hz, 2H, S- $\text{CH}_2\text{-C}$ ) 2.94 (m,  $J=6.66$  Hz, 2H,  $\text{CH}(\text{CH}_3)_2$ )

$^{13}\text{C}$   $\{^1\text{H}\}$  NMR ( $\text{CDCl}_3$ , 62.86 MHz,  $\delta$  [ppm]): 8.04 (s, C- $\text{CH}_2\text{CH}_3$ ), 23.74 (s,  $\text{CH}(\text{CH}_3)_2$ ), 31.43 (s, C- $\text{CH}_2\text{CH}_3$ ), 36.77 (s,  $\text{CH}(\text{CH}_3)_2$ ), 39.72 (s, S- $\text{CH}_2\text{-C}$ ), 73.84 (s, C-OH)

IR (ATR,  $\text{cm}^{-1}$ ):  $\nu$ = 3475 (br, OH), 2960 (s, CH), 1238 (s, OH)

GC-EIMS (m/z) found (calc.): 236.07 (236.13)  $[\text{M}]^+$ , 193.03 (193.07)  $[\text{M} - ^i\text{C}_3\text{H}_9]^+$ , 132.97 (133.07)  $[\text{M} - ^i\text{PrS} - \text{C}_2\text{H}_4]^+$ , 104.98 (105.04)  $[\text{M} - ^i\text{C}_3\text{H}_9 - i\text{PrSCH}_2]^+$

### Compound 19:

bp: 55°C / 3.5 mbar

$^1\text{H}$  NMR ( $\text{CDCl}_3$ , 200 MHz,  $\delta$  [ppm]): 0.94 (t,  $J=7.53$  Hz, 3H, C- $\text{CH}_2\text{CH}_3$ ), 1.26 (d,  $J=6.67$  Hz, 6H,  $\text{CH}(\text{CH}_3)_2$ ), 1.76 (m,  $J=7.42$  Hz, 2H, C- $\text{CH}_2\text{CH}_3$ ), 2.60-2.83 (m, 4H,  $\text{CH}_2\text{-O}$ , C- $\text{CH}_2\text{-S}$ ), 2.98 (m,  $J=6.65$  Hz, 1 H,  $\text{CH}(\text{CH}_3)_2$ )

$^{13}\text{C}$   $\{^1\text{H}\}$  NMR ( $\text{CDCl}_3$ , 62.86 MHz,  $\delta$  [ppm]): 8.90 (s, C- $\text{CH}_2\text{CH}_3$ ), 23.48 (d,  $\text{CH}(\text{CH}_3)_2$ ), 26.14 (s, C- $\text{CH}_2\text{CH}_3$ ), 35.25 (s, C- $\text{CH}_2\text{-S}$ ), 35.52 (s,  $\text{CH}(\text{CH}_3)_2$ ), 52.05 (s,  $\text{CH}_2\text{-O}$ ), 59.74 (s,  $\text{CH}_2\text{-C-O}$ )

IR (ATR,  $\text{cm}^{-1}$ ):  $\nu$ = 2966 (s, CH), 748 (m, Epoxide ringmode)

GC-EIMS (m/z) found (calc.): 160.09 (160.09)  $[\text{M}]^+$ , 89.05 (89.01)  $[\text{M} - ^i\text{C}_3\text{H}_9 - \text{C}_2\text{H}_5]^+$ , 55.09 (55.02)  $[\text{M} - i\text{PrSH} - \text{C}_2\text{H}_5]^+$

### 1- $^n$ Butylthio-2-(( $^n$ butylthio)methyl)butan-2-ol (20),

and

### 2-(( $^n$ Butylthio)methyl)-2-ethyloxirane (21):

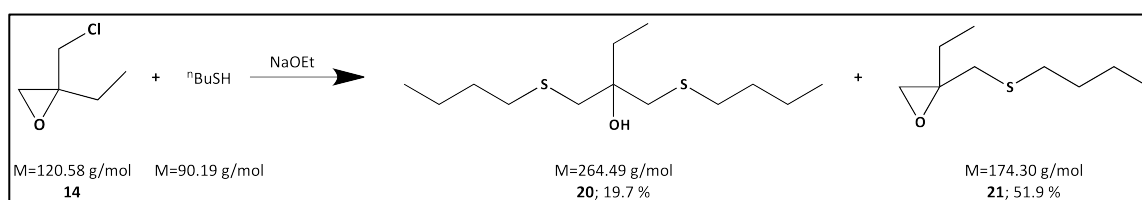

1.53 g (66.35 mmol, 1 equiv.) Na were dissolved in ca. 50 ml absolute EtOH before adding 5.98 g (66.35 mmol, 1 equiv.)  $^n$ butanethiol. After 10 minutes, 8 g (66.35 mmol, 1 equiv.) of **14** was added at room temperature. A white precipitate formed instantly and the temperature increased rapidly. After stirring at room temperature over night, water was added and the reaction neutralised with 0.5 N HCl. The mixture was then extracted with

chloroform, the combined organic layers washed with saturated brine, dried over  $\text{Na}_2\text{SO}_4$ , filtered and the solvent removed in vacuum. The crude product was then purified by fractionated distillation at reduced pressure to yield 6.00 g (34.4 mmol, 51.9 %) of **20** at 110 °C (0.5 mbar) and 3.46 g (13.1 mmol, 19.7 %) of **21** at 44 °C (0.5 mbar) as clear, colourless liquids.

**Compound 20:**

$^1\text{H}$  NMR ( $\text{CDCl}_3$ , 200 MHz,  $\delta$  [ppm]): 0.91 (t,  $J=7.23$  Hz, 9H,  $\text{CH}_3\text{CH}_2\text{CH}_2$ , C- $\text{CH}_2\text{CH}_3$ ), 1.40 (m,  $J=7.30$  Hz, 4H,  $\text{CH}_3\text{CH}_2\text{CH}_2$ ), 1.59 (m, 6H,  $\text{CH}_2\text{CH}_2\text{-S}$ , C- $\text{CH}_2\text{CH}_3$ ), 2.58 (q,  $J=6.94$  Hz, 4H,  $\text{CH}_2\text{CH}_2\text{-S}$ ) 2.65 (d,  $J=13.09$  Hz, 1H, S- $\text{CH}_2\text{-C}$ ), 2.80 (d,  $J=13.09$  Hz, 1H, S- $\text{CH}_2\text{-C}$ )

$^{13}\text{C}$  { $^1\text{H}$ } NMR ( $\text{CDCl}_3$ , 62.86 MHz,  $\delta$  [ppm]): 8.05 (s, C- $\text{CH}_2\text{CH}_3$ ), 13.79 (s,  $\text{CH}_3\text{CH}_2\text{CH}_2$ ), 22.03 (s,  $\text{CH}_3\text{CH}_2\text{CH}_2$ ), 31.24 (s, C- $\text{CH}_2\text{CH}_3$ ), 32.12 (s,  $\text{CH}_2\text{CH}_2\text{-S}$ ), 33.96 (s,  $\text{CH}_2\text{CH}_2\text{-S}$ ), 41.48 (s, S- $\text{CH}_2\text{-C}$ ), 74.39 (s, C-OH)

IR (ATR,  $\text{cm}^{-1}$ ):  $\nu=3466$  (br, OH), 2958 (s, CH), 1223 (m, OH)

GC-EIMS (m/z) found (calc.): 264.14 (264.16)  $[\text{M}]^+$ , 161.12 (161.10)  $[\text{M} - ^n\text{BuSCH}_2]^+$ , 105.06 (105.04)  $[\text{M} - ^n\text{BuSCH}_2 - \text{C}_4\text{H}_9]^+$

**Compound 21:**

$^1\text{H}$  NMR ( $\text{CDCl}_3$ , 200 MHz,  $\delta$  [ppm]): 0.86-1.00 (m, 6H,  $\text{CH}_3\text{CH}_2\text{CH}_3$ , C- $\text{CH}_2\text{CH}_3$ ), 1.41 (m,  $J=7.36$  Hz, 2H,  $\text{CH}_3\text{CH}_2\text{CH}_2$ ), 1.56 (quint,  $J=7.27$  Hz, 2H,  $\text{CH}_2\text{CH}_2\text{-S}$ ), 1.78 (m,  $J=7.29$  Hz, 2H, C- $\text{CH}_2\text{CH}_3$ ), 2.51-2.79 (m, 6H,  $\text{CH}_2\text{CH}_2\text{-S}$ , S- $\text{CH}_2\text{-C}$ ,  $\text{CH}_2\text{-O}$ )

$^{13}\text{C}$  { $^1\text{H}$ } NMR ( $\text{CDCl}_3$ , 62.86 MHz,  $\delta$  [ppm]): 8.89 (s, C- $\text{CH}_2\text{CH}_3$ ), 13.79 (s,  $\text{CH}_3\text{CH}_2\text{CH}_2$ ), 22.08 (s,  $\text{CH}_3\text{CH}_2\text{CH}_2$ ), 26.03 (s, C- $\text{CH}_2\text{CH}_3$ ), 31.77 (s,  $\text{CH}_2\text{CH}_2\text{-S}$ ), 32.69 (s,  $\text{CH}_2\text{CH}_2\text{-S}$ ), 36.77 (s, S- $\text{CH}_2\text{-C}$ ), 51.86 (s,  $\text{CH}_2\text{-O}$ ), 59.77 (s,  $\text{CH}_2\text{-C-O}$ )

IR (ATR,  $\text{cm}^{-1}$ ):  $\nu=2960$  (s, CH), 752 (m, Epoxide ringmode)

GC-EIMS (m/z) found (calc.): 174.07 (174.04)  $[\text{M}]^+$ , 85.07 (85.07)  $[\text{M} - ^n\text{BuS}]^+$ , 61.03 (61.01)  $[\text{EtS}]^+$

**1-<sup>t</sup>Butylthio-2-((<sup>t</sup>butylthio)methyl)butan-2-ol (22),**

**and**

**2-((<sup>t</sup>Butylthio)methyl)-2-ethyloxirane (23):**

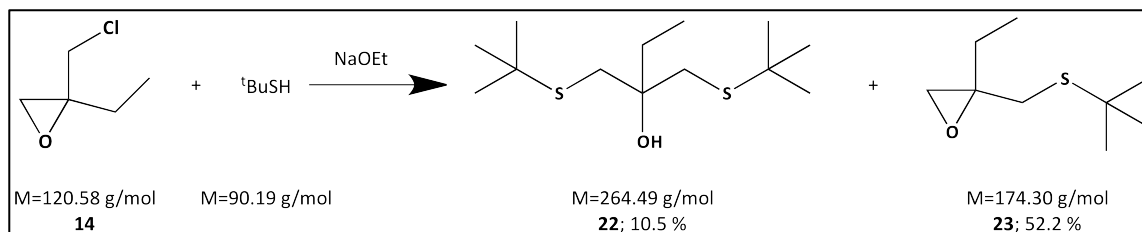

The synthesis was carried out similar to the <sup>n</sup>butyl analogue (**20/21**) using 8 g (66.35 mmol, 1 equiv.) of **14**, 5.98 g (66.35 mmol, 1 equiv.) <sup>t</sup>butanethiol and 1.53 g (66.35 mmol, 1 equiv.) Na. Since column chromatography in various solvent mixtures had proven to be insufficient, the mixture was distilled at reduced pressure to give 1.9 g (7.0 mmol, 10.5 %) of **22** at 83 °C (0.5 mbar) and 6.04 g (34.6 mmol, 52.2 %) of **23** at 32 °C (0.85 mbar) as clear, colourless liquids.

**Compound 22:**

**<sup>1</sup>H NMR (CDCl<sub>3</sub>, 200 MHz, δ [ppm]):** 0.95 (t, J=7.42 Hz, 3H, C-CH<sub>2</sub>CH<sub>3</sub>), 1.32 (s, 18H, C(CH<sub>3</sub>)<sub>3</sub>), 1.61 (q, J=7.51 Hz, 2H, C-CH<sub>2</sub>CH<sub>3</sub>), 2.63 (d, J=12.09 Hz, 1H, S-CH<sub>2</sub>-C), 2.80 (d, J=12.09 Hz, 1H, S-CH<sub>2</sub>-C), 2.77 (s, 1H, OH)

**<sup>13</sup>C {<sup>1</sup>H} NMR (CDCl<sub>3</sub>, 62.86 MHz, δ [ppm]):** 7.98 (s, C-CH<sub>2</sub>CH<sub>3</sub>), 31.08 (s, C(CH<sub>3</sub>)<sub>3</sub>), 31.68 (s, C-CH<sub>2</sub>CH<sub>3</sub>), 37.45 (s, S-CH<sub>2</sub>-C), 42.38 (s, C(CH<sub>3</sub>)<sub>3</sub>), 72.84 (s, C-OH)

**IR (ATR, cm<sup>-1</sup>):** ν = 3475 (br, OH), 2961 (s, CH)

**GC-EIMS (m/z) found (calc.):** 207.06 (207.09) [M -<sup>t</sup>C<sub>4</sub>H<sub>9</sub>]<sup>+</sup>, 132.96 (133.07) [M -<sup>t</sup>BuSCH<sub>2</sub> - C<sub>2</sub>H<sub>4</sub>]<sup>+</sup>, 57.04 (57.07) [C<sub>4</sub>H<sub>9</sub>]<sup>+</sup>

**Compound 23:**

**<sup>1</sup>H NMR (CDCl<sub>3</sub>, 200 MHz, δ [ppm]):** 0.94 (t, J=7.41 Hz, 3H, C-CH<sub>2</sub>CH<sub>3</sub>), 1.32 (s, 9H, C(CH<sub>3</sub>)<sub>3</sub>), 1.76 (qd, J=1.78 / 7.44 Hz, 2H, C-CH<sub>2</sub>CH<sub>3</sub>), 2.69 (d, J= 12.57 Hz, 1H, S-CH<sub>2</sub>-C), 2.70 (q, J=4.66 Hz, 2H, CH<sub>2</sub>-O), 2.85 (d, J= 12.57 Hz, 1H, S-CH<sub>2</sub>-C)

**<sup>13</sup>C {<sup>1</sup>H} NMR (CDCl<sub>3</sub>, 62.86 MHz, δ [ppm]):** 8.80 (s, C-CH<sub>2</sub>CH<sub>3</sub>), 26.37 (s, C-CH<sub>2</sub>CH<sub>3</sub>), 30.98 (s, C(CH<sub>3</sub>)<sub>3</sub>), 33.41 (s, S-CH<sub>2</sub>-C), 42.18 (s, C(CH<sub>3</sub>)<sub>3</sub>), 52.73 (s, CH<sub>2</sub>-O), 59.42 (s, CH<sub>2</sub>-C-O)

IR (ATR,  $\text{cm}^{-1}$ ):  $\nu = 2966$  (s, CH),  $762$  (m, Epoxide ringmode)

GC-EIMS (m/z) found (calc.):  $174.07$  ( $174.11$ )  $[\text{M}]^+$ ,  $85.06$  ( $85.07$ )  $[\text{M} - ^t\text{BuS}]^+$ ,  $57.09$  ( $57.03$ )  $[\text{M} - ^t\text{BuS} - \text{C}_2\text{H}_4]^+$

### 1-Diethylamino-2-((ethylthio)methyl)butan-2-ol (24):

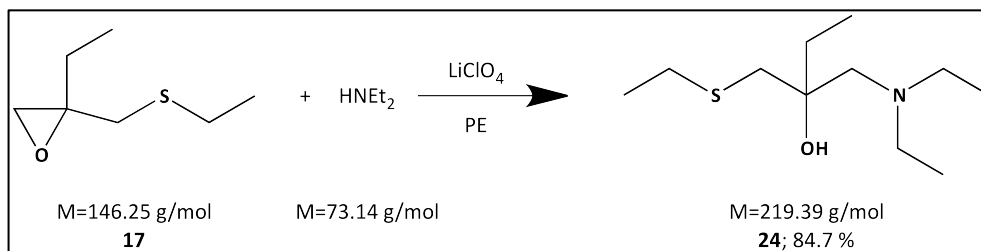

3.6 ml (34.5 mmol, 2.5 equiv.) diethylamine were mixed with a solution of 2.017 g (13.8 mmol, 1 equiv.) of **17** in 13 ml petrol ether and 0.3 ml 5 M  $\text{LiClO}_4$  in diethyl ether were added and the mixture was then refluxed for 18 h. After cooling to room temperature, 20 ml saturated brine were added, phases separated and the water phase further extracted thrice with petrol ether. The collected organic phases were dried over  $\text{Na}_2\text{SO}_4$ , filtered and the solvent removed to give a clear, yellow liquid. Distillation at  $70^\circ\text{C}$  (0.65 mbar) yielded 2.57 g (11.7 mmol, 84.7 %) of **24** as a clear, colourless liquid.

$^1\text{H}$  NMR ( $\text{CDCl}_3$ , 200 MHz,  $\delta$  [ppm]): 0.91 (t,  $J=7.45$  Hz, 3H, C- $\text{CH}_2\text{CH}_3$ ), 1.02 (t,  $J=7.11$  Hz, 6H,  $\text{N}(\text{CH}_2\text{CH}_3)_2$ ), 1.25 (t,  $J=7.42$  Hz, 3H, S- $\text{CH}_2\text{CH}_3$ ), 1.53 (qd,  $J=7.45 / 1.53$  Hz, 2H, C- $\text{CH}_2\text{CH}_3$ ), 2.33 (d,  $J=13.98$  Hz, 1H, S- $\text{CH}_2$ -C), 2.52-2.68 (m, 9H, S- $\text{CH}_2\text{CH}_3$ , S- $\text{CH}_2$ -C, C- $\text{CH}_2$ -N,  $\text{N}(\text{CH}_2\text{CH}_3)_2$ ), 3.80 (s, 1H, OH)

$^{13}\text{C}$   $\{^1\text{H}\}$  NMR ( $\text{CDCl}_3$ , 62.86 MHz,  $\delta$  [ppm]): 7.91 (s, C- $\text{CH}_2\text{CH}_3$ ), 12.41 (s,  $\text{N}(\text{CH}_2\text{CH}_3)_2$ ), 15.05 (s, S- $\text{CH}_2\text{CH}_3$ ), 27.78 (s, S- $\text{CH}_2\text{CH}_3$ ), 30.77 (s, C- $\text{CH}_2\text{CH}_3$ ), 40.24 (s, C- $\text{CH}_2$ -S), 49.09 (s,  $\text{N}(\text{CH}_2\text{CH}_3)_2$ ), 59.88 (s, C- $\text{CH}_2$ -N), 72.68 (s, C-OH)

IR (ATR,  $\text{cm}^{-1}$ ):  $\nu = 3457$  (br, OH),  $2966$  (s, CH),  $1064$  (s, C-N)

GC-EIMS (m/z) found (calc.):  $144.13$  ( $144.14$ )  $[\text{M} - ^t\text{BuSCH}_2]^+$ ,  $86.07$  ( $86.10$ )  $[\text{Et}_2\text{NCH}_2]^+$ ,  $58.09$  ( $58.04$ )  $[\text{CH}_3\text{C}(=\text{O})\text{CH}_3]^+$

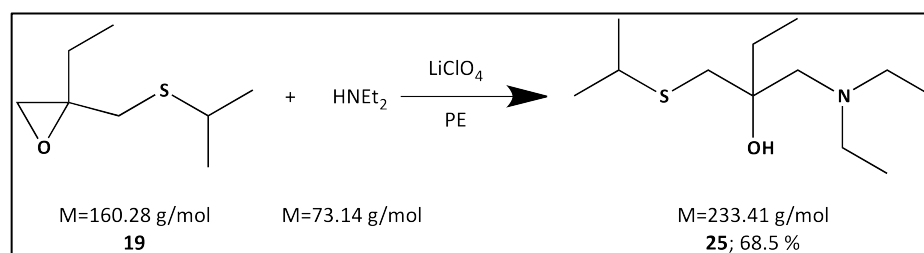
**1-Diethylamino-2-((isopropylthio)methyl)butan-2-ol (25):**

The synthesis was carried out similar to the ethyl analogue (**24**) using 2.6 g (16.22 mmol, 1 equiv.) of **19** and 4.3 ml (40.55 mmol, 2.5 equiv.) diethylamine, 0.3 ml 5 M LiClO<sub>4</sub> solution and 15 ml petrol ether. The mixture was refluxed for 24 h yielding 2.44 g (10.5 mmol, 68.5 %) of **25** as a clear, lightly yellow liquid. The product could be distilled at 75 °C (0.79 mbar).

**<sup>1</sup>H NMR (CDCl<sub>3</sub>, 200 MHz, δ [ppm]):** 0.91 (t, J=7.41 Hz, 3H, C-CH<sub>2</sub>CH<sub>3</sub>), 1.01 (t, J=7.09 Hz, 6H, N(CH<sub>2</sub>CH<sub>3</sub>)<sub>2</sub>), 1.27 (d, J=6.62 Hz, 6H, CH(CH<sub>3</sub>)<sub>2</sub>), 1.46-1.61 (m, 2H, C-CH<sub>2</sub>CH<sub>3</sub>), 2.33 (d, J=14.04 Hz, 1H, S-CH<sub>2</sub>-C), 2.53-2.69 (m, 7H, S-CH<sub>2</sub>-C, N-CH<sub>2</sub>-C, N(CH<sub>2</sub>CH<sub>3</sub>)<sub>2</sub>), 2.90 (m, J=6.67 Hz, 1H, CH(CH<sub>3</sub>)<sub>2</sub>), 3.83 (s, 1H, OH)

**<sup>13</sup>C {<sup>1</sup>H} NMR (CDCl<sub>3</sub>, 62.86 MHz, δ [ppm]):** 7.84 (s, C-CH<sub>2</sub>CH<sub>3</sub>), 12.41 (s, N(CH<sub>2</sub>CH<sub>3</sub>)<sub>2</sub>), 23.63 (s, CH(CH<sub>3</sub>)<sub>2</sub>), 30.76 (s, C-CH<sub>2</sub>CH<sub>3</sub>), 36.29 (s, CH(CH<sub>3</sub>)<sub>2</sub>), 38.67 (s, S-CH<sub>2</sub>-C), 49.07 (s, N(CH<sub>2</sub>CH<sub>3</sub>)<sub>2</sub>), 59.97 (s, N-CH<sub>2</sub>-C), 72.48 (s, C-OH)

**IR (ATR, cm<sup>-1</sup>):** ν = 3458 (br, OH), 2966 (s, CH), 1063 (s, C-N)

**GC-EIMS (m/z) found (calc.):** 144.15 (144.14) [M -<sup>t</sup>BuSCH<sub>2</sub>]<sup>+</sup>, 86.04 (86.10) [Et<sub>2</sub>NCH<sub>2</sub>]<sup>+</sup>, 58.09 (58.09) [CH<sub>3</sub>C(=O)CH<sub>3</sub>]<sup>+</sup>

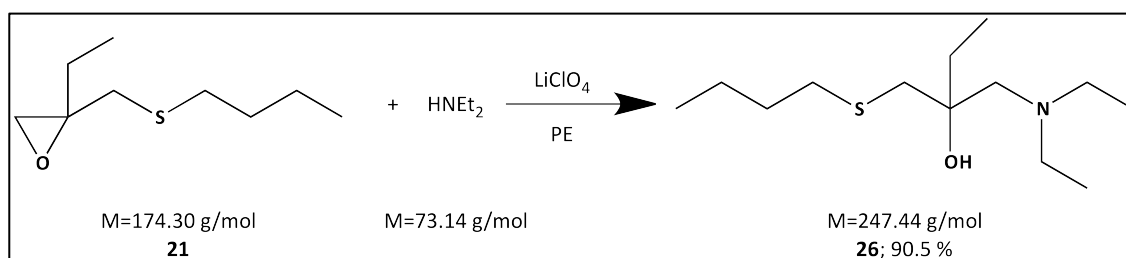
**1-<sup>n</sup>Butylthio-2-((diethylamino)methyl)butan-2-ol (26):**

The synthesis was carried out similar to the ethyl analogue (**24**) mentioned above using 6.0 g (34.5 mmol, 1 equiv.) of **21**, 9.0 ml (86.1 mmol, 2.5 equiv.) diethylamine, 0.3 ml 5 M LiClO<sub>4</sub>

solution and 25 ml of petrol ether while refluxing for 24 h. The product could be distilled at 108 °C (1.2 mbar) yielding 7.72 g (31.2 mmol, 90.5 %) of **26** as a clear, light yellow liquid.

**<sup>1</sup>H NMR (CDCl<sub>3</sub>, 200 MHz, δ [ppm]):** 0.90 (t, J=7.30 Hz, 6H, C-CH<sub>2</sub>CH<sub>3</sub>, CH<sub>3</sub>CH<sub>2</sub>CH<sub>2</sub>), 1.01 (t, J=7.17 Hz, 6H, N(CH<sub>2</sub>CH<sub>3</sub>)<sub>2</sub>), 1.41 (m, J=7.25 Hz, 2H, CH<sub>3</sub>CH<sub>2</sub>CH<sub>2</sub>), 1.46-1.64 (m, 4H, CH<sub>2</sub>CH<sub>2</sub>-S, C-CH<sub>2</sub>CH<sub>3</sub>), 2.33 (d, J=14.04 Hz, 1H, S-CH<sub>2</sub>-C), 2.51-2.66 (m, 9H, CH<sub>2</sub>CH<sub>2</sub>-S, S-CH<sub>2</sub>-C, N-CH<sub>2</sub>-C, N(CH<sub>2</sub>CH<sub>3</sub>)<sub>2</sub>), 3.80 (s, 1H, OH)

**<sup>13</sup>C {<sup>1</sup>H} NMR (CDCl<sub>3</sub>, 62.86 MHz, δ [ppm]):** 7.89 (s, C-CH<sub>2</sub>CH<sub>3</sub>), 12.39 (s, N(CH<sub>2</sub>CH<sub>3</sub>)<sub>2</sub>), 13.81 (s, CH<sub>3</sub>CH<sub>2</sub>CH<sub>2</sub>), 22.07 (s, CH<sub>3</sub>CH<sub>2</sub>CH<sub>2</sub>), 30.72 (s, C-CH<sub>2</sub>CH<sub>3</sub>), 31.97 (s, CH<sub>2</sub>CH<sub>2</sub>-S), 33.63 (s, S-CH<sub>2</sub>CH<sub>2</sub>), 40.66 (s, S-CH<sub>2</sub>-C), 49.07 (s, N(CH<sub>2</sub>CH<sub>3</sub>)<sub>2</sub>), 59.82 (s, N-CH<sub>2</sub>-C), 72.67 (s, C-OH)

**IR (ATR, cm<sup>-1</sup>):** ν = 3465 (br, OH), 2963 (s, CH), 1063 (s, C-N)

**GC-EIMS (m/z) found (calc.):** 144.08 (144.14) [M -<sup>n</sup>BuSCH<sub>2</sub>]<sup>+</sup>, 86.03 (86.10) [Et<sub>2</sub>NCH<sub>2</sub>]<sup>+</sup>, 58.10 (58.04) [CH<sub>3</sub>C(=O)CH<sub>3</sub>]<sup>+</sup>

### 1-<sup>t</sup>Butylthio-2-((diethylamino)methyl)butan-2-ol (**27**):

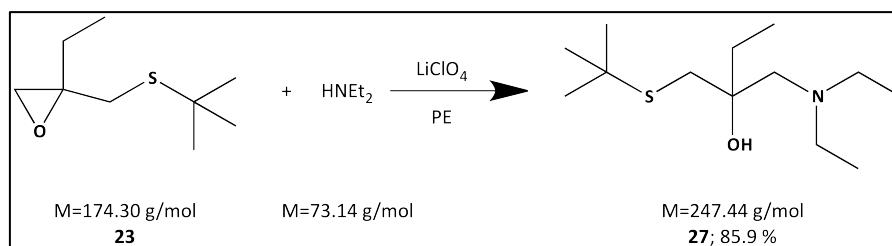

The synthesis was carried out similar to the thioether analogues (**24-26**) mentioned before, using 6.03 g (34.60 mmol, 1 equiv.) of **23**, 9.0 ml (86.52 mmol, 2.5 equiv.) diethylamine, 0.3 ml 5 M LiClO<sub>4</sub> solution and 25 ml petrol ether. The reaction was refluxed for 3.5 d and yielded 7.40 g (29.9 mmol, 86.4 %) **27** as clear liquid, which could be distilled at 69 °C (0.2 mbar).

**<sup>1</sup>H NMR (CDCl<sub>3</sub>, 200 MHz, δ [ppm]):** 0.93 (t, J=7.34 Hz, 3H, C-CH<sub>2</sub>CH<sub>3</sub>), 1.01 (t, J=7.09 Hz, 6H, N(CH<sub>2</sub>CH<sub>3</sub>)<sub>2</sub>), 1.31 (s, 9H, C(CH<sub>3</sub>)<sub>3</sub>), 1.49 (m, 2H, C-CH<sub>2</sub>CH<sub>3</sub>), 2.31 (d, J=14.05 Hz, 1H, S-CH<sub>2</sub>-C) 2.50-2.69 (m, 7H, C-CH<sub>2</sub>-S, N-CH<sub>2</sub>-C, N(CH<sub>2</sub>CH<sub>3</sub>)<sub>2</sub>), 3.89 (s, 1H, OH)

**<sup>13</sup>C {<sup>1</sup>H} NMR (CDCl<sub>3</sub>, 62.86 MHz, δ [ppm]):** 7.70 (s, C-CH<sub>2</sub>CH<sub>3</sub>), 12.50 (s, N(CH<sub>2</sub>CH<sub>3</sub>)<sub>2</sub>), 30.86 (s, C-CH<sub>2</sub>CH<sub>3</sub>), 30.94 (s, C(CH<sub>3</sub>)<sub>3</sub>), 35.94 (s, S-CH<sub>2</sub>-C), 41.83 (s, C(CH<sub>3</sub>)<sub>3</sub>), 49.08 (s, N(CH<sub>2</sub>CH<sub>3</sub>)<sub>2</sub>), 60.33 (s, N-CH<sub>2</sub>-C), 72.13 (s, C-OH)

**IR (ATR, cm<sup>-1</sup>):** ν = 3467 (br, OH), 2964 (s, CH), 1064 (s, C-N)



**GC-EIMS (m/z) found (calc.):** 144.10 (144.14) [ $M - {}^t\text{BuSCH}_2$ ] $^+$ , 86.02 (86.10) [ $\text{Et}_2\text{NCH}_2$ ] $^+$ , 58.10 (58.04) [ $\text{CH}_3\text{C}(=\text{O})\text{CH}_3$ ] $^+$

## 5.4 Alkoxide Syntheses

### Potassium tert.-butanolate (28):

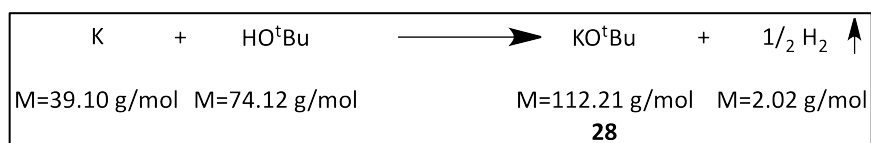

Elemental potassium was added in small pieces to approximately 150 ml <sup>t</sup>BuOH in 100 ml toluene. When dissolution became slower, the mixture was heated and more potassium added until saturation was achieved. Adding small portions <sup>t</sup>BuOH dissolved remaining potassium. After the reaction was complete, toluene and residual alcohol were distilled off at reduced pressure yielding a colourless crystalline solid. The crude product was dried at reduced pressure and purified via sublimation at approx. 120 °C at 0.6 mbar.

<sup>1</sup>H NMR (C<sub>6</sub>D<sub>6</sub>, 200 MHz, δ [ppm]): 1.15 (s, CH<sub>3</sub>)

<sup>13</sup>C {<sup>1</sup>H} NMR (C<sub>6</sub>D<sub>6</sub>, 62.86 MHz, δ [ppm]): 38.35 (s, C(CH<sub>3</sub>)<sub>3</sub>), 67.11 (s, C(CH<sub>3</sub>)<sub>3</sub>)

### Gallium tris(tert.-butanolate) (29):

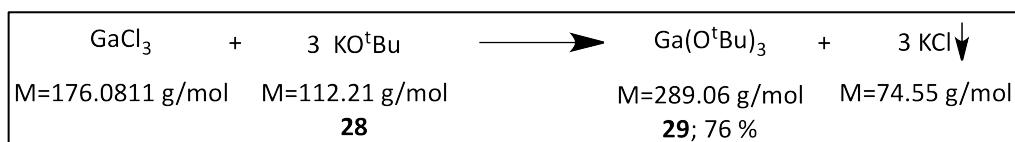

1.96 g (11.1 mmol, 1 equiv.) GaCl<sub>3</sub> was activated by 15 ml THF at 77 K and 25 ml toluene were added before the solution was cooled with liquid nitrogen again. In a separate flask 4.04 g (36.0 mmol, 3.2 equiv.) KO<sup>t</sup>Bu (**28**) were dissolved in ca. 50 ml hot toluene. This solution was then slowly added to the cooled GaCl<sub>3</sub> solution, which was then allowed to warm up to room temperature and refluxed for 2 d. The formed KCl was removed by

filtration and the solvent was removed under reduced pressure. The crude product was purified by sublimation at 120 °C (0.1 mbar) to afford 2.45 g (8.5 mmol, 76.4 %) of compound **29** as colourless crystals.

$^1\text{H}$  NMR ( $\text{CDCl}_3$ , 200 MHz,  $\delta$  [ppm]): 1.32 (s, 32H, O-C( $\underline{\text{C}}\text{H}_3$ )<sub>3</sub>), 1.54 (s, 16H,  $\mu_2\text{O}$ -C( $\underline{\text{C}}\text{H}_3$ )<sub>3</sub>)

$^{13}\text{C}$  { $^1\text{H}$ } NMR ( $\text{C}_6\text{D}_6$ , 62.86 MHz,  $\delta$  [ppm]): 32.37 (s,  $\mu_2\text{O}$ -C( $\underline{\text{C}}\text{H}_3$ )<sub>3</sub>), 34.11 (s, O-C( $\underline{\text{C}}\text{H}_3$ )<sub>3</sub>), 71.95 (s, O- $\underline{\text{C}}$ ( $\text{CH}_3$ )<sub>3</sub>), 78.68 (s,  $\mu_2\text{O}$ - $\underline{\text{C}}$ ( $\text{CH}_3$ )<sub>3</sub>)

### Lithium hexamethyldisilazane (30):

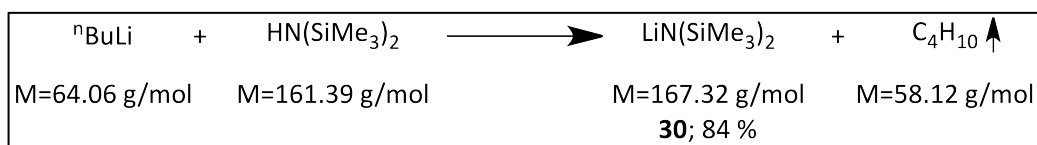

45.2 ml (111.3 mmol, 1 equiv.) 2.5 M solution  ${}^n$ butyllithium in hexane were slowly added to 21.22 g (131.5 mmol, 1.18 equiv.) hexamethyldisilazane at 77 K. The reaction mixture was allowed to warm up to room temperature and after 2 h all volatiles were removed at reduced pressure. The crude product was purified via sublimation at 80 °C ( $2 \times 10^{-2}$  mbar) yielding 15.6 g (69.1 mmol, 83.6 %) of the pure product (**30**) as colourless crystals.

$^1\text{H}$  NMR ( $\text{CDCl}_3$ , 200 MHz,  $\delta$  [ppm]): 0.22 (s,  $\underline{\text{C}}\text{H}_3$ )

$^{13}\text{C}$  { $^1\text{H}$ } NMR ( $\text{CDCl}_3$ , 62.86 MHz,  $\delta$  [ppm]): 5.84 (s,  $\underline{\text{C}}\text{H}_3$ )

### Indium tris(hexamethyldisilazane) (31):

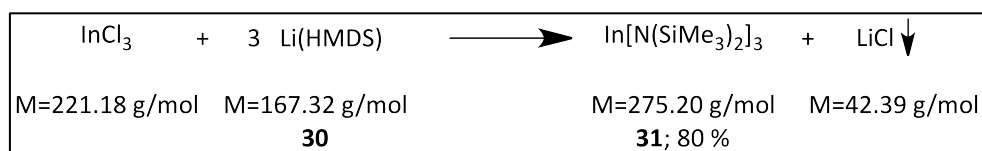

2.46 g (11.1 mmol, 1 equiv.)  $\text{InCl}_3$  were activated using a few ml THF at 77 K and 25 ml toluene were subsequently added. In a second flask, 5.59 g (33.4 mmol, 3 equiv.) LiHMDS (**30**) were dissolved in toluene and the solution transferred to the cold  $\text{InCl}_3$  solution (77 K). After refluxing the mixture for 1.5 d, the formed LiCl was removed via filtration. Following the removal of the solvent, the light yellow crude product was sublimated at 120 °C

( $4 \times 10^{-2}$  mbar) to yield 5.32 g (8.9 mmol, 80.4 %) of the pure product (**31**) as colourless crystals.

$^1\text{H}$  NMR ( $\text{CDCl}_3$ , 200 MHz,  $\delta$  [ppm]): 0.34 (s,  $\text{CH}_3$ )

$^{13}\text{C}$   $\{^1\text{H}\}$  NMR ( $\text{C}_6\text{D}_6$ , 62.86 MHz,  $\delta$  [ppm]): 5.94 (s,  $\text{CH}_3$ )

### Indium tris(tert.-butanolate) (32):

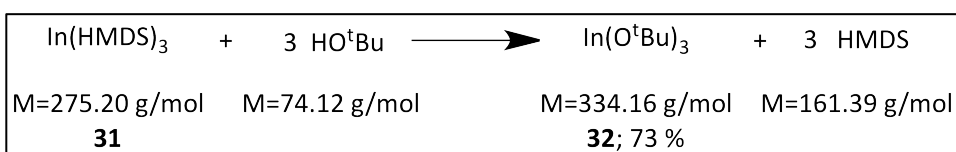

2.653 g (4.45 mmol, 1 equiv.)  $\text{In}(\text{HMDS})_3$  (**31**) were dissolved in 40 ml of toluene and 1.65 g (22.26 mmol, 1 equiv.) tert.-butanol were added. The reaction was stirred over night at 65 °C before all volatiles were removed at reduced pressure. The lightly yellow crude product was purified via sublimation at 110 °C and  $5 \times 10^{-2}$  mbar yielding 1.083 g (3.2 mmol, 72.8 %) pure product (**32**) as a colourless solid.

$^1\text{H}$  NMR ( $\text{CDCl}_3$ , 200 MHz,  $\delta$  [ppm]): 1.32 (s, 32H,  $\text{O}-\text{C}(\text{CH}_3)_3$ ), 1.50 (s, 16H,  $\mu_2\text{O}-\text{C}(\text{CH}_3)_3$ )

$^{13}\text{C}$   $\{^1\text{H}\}$  NMR ( $\text{CDCl}_3$ , 62.86 MHz,  $\delta$  [ppm]): 33.79 (s,  $\mu_2\text{O}-\text{C}(\text{CH}_3)_3$ ), 35.19 (s,  $\text{O}-\text{C}(\text{CH}_3)_3$ ), 71.87 (s,  $\text{O}-\text{C}(\text{CH}_3)_3$ ), 76.13 (s,  $\mu_2\text{O}-\text{C}(\text{CH}_3)_3$ )

### Gallium tris[1,3-bis(isopropylthio)propan-2-olate] (33):

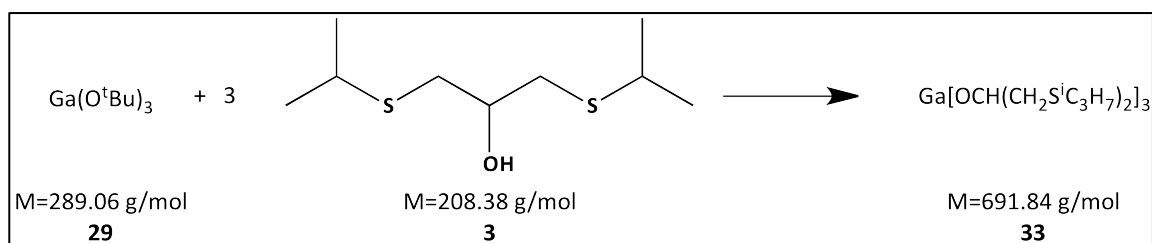

0.26 g (1.00 mmol, 1 equiv.)  $\text{Ga}(\text{O}^t\text{Bu})_3$  (**29**) were dissolved in 5 ml toluene and 0.66 g (3.2 mmol, 3.2 equiv.) of **3** were added. Ligand exchange occurred within 3 days at 50 °C. The volatile compounds were removed under reduced pressure. Minor residual tert.-

butanolate impurities were removed by adding 3 additional drops of the alcohol in 1 ml toluene to the alkoxide.

$^1\text{H}$  NMR ( $\text{CDCl}_3$ , 200 MHz,  $\delta$  [ppm]): 1.18-1.36 (m, 12H,  $\text{CH}(\text{CH}_3)_2$ ), 2.58-2.96 (m,  $\text{S-CH}_2\text{-CH}$ ), 3.06 (m,  $J=6.69$  Hz, 2H,  $\text{CH}(\text{CH}_3)_2$ ), 3.91 (m,  $J=5.87$  Hz, 0.5H,  $\text{CH-O}$ ), 4.11 (m, 0.5H,  $\text{CH-O}$ )

$^{13}\text{C}$   $\{^1\text{H}\}$  NMR ( $\text{CDCl}_3$ , 62.86 MHz,  $\delta$  [ppm]): 23.21 (s,  $\text{CH}(\text{CH}_3)_2$ ), 23.36 (s,  $\text{CH}(\text{CH}_3)_2$ ), 35.75 (s,  $\text{S-CH}_2\text{-CH}$ ), 39.08 (s,  $\text{CH}(\text{CH}_3)_2$ ), 70.71 (s,  $\text{CH-O}$ )

### Gallium tris[1,3-bis( $n$ butylthio)propan-2-olate] (34):

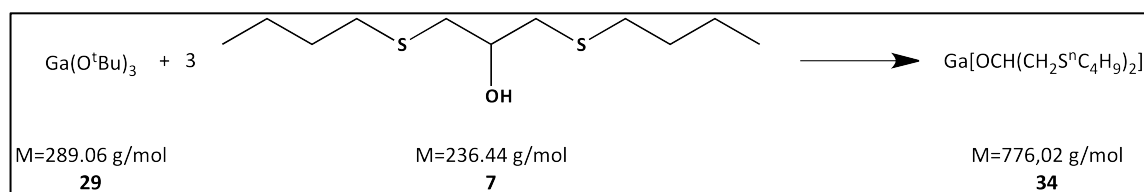

0.21 g (0.73 mmol, 1 equiv.)  $\text{Ga}(\text{O}^t\text{Bu})_3$  (**29**) were dissolved in 5 ml toluene and 0.55 g (2.33 mmol, 3.2 equiv.) of **7** were added. Ligand exchange occurred within 3 days at 50 °C. The volatile compounds were removed under reduced pressure. Minor residual tert.-butanolate impurities were removed by adding 3 additional drops of the alcohol in 1 ml toluene to the alkoxide and heating to 80 °C for 4 h.

$^1\text{H}$  NMR ( $\text{CDCl}_3$ , 200 MHz,  $\delta$  [ppm]): 0.90 (t,  $J=7.13$  Hz, 6H,  $\text{CH}_3\text{CH}_2\text{CH}_2$ ), 1.39 (m,  $J=7.41$  Hz, 4H,  $\text{CH}_3\text{CH}_2\text{CH}_2$ ), 1.56 (quint.,  $J=6.68$  Hz, 4H,  $\text{CH}_2\text{CH}_2\text{-S}$ ), 2.46-2.70 (m, 5H,  $\text{CH}_2\text{CH}_2\text{-S}$ ,  $\text{S-CH}_2\text{-CH}$ ), 2.70-2.91 (m, 3H,  $\text{S-CH}_2\text{-CH}$ ), 3.90 (m,  $J=5.76$  Hz, 0.5H,  $\text{CH-O}$ ), 4.08 (m, 0.5H,  $\text{CH-O}$ )

$^{13}\text{C}$   $\{^1\text{H}\}$  NMR ( $\text{CDCl}_3$ , 62.86 MHz,  $\delta$  [ppm]): 13.83 (s,  $\text{CH}_3\text{CH}_2\text{CH}_2$ ), 22.15 (s,  $\text{CH}_3\text{CH}_2\text{CH}_2$ ), 31.61 (s,  $\text{CH}_2\text{CH}_2\text{-S}$ ), 32.10 (s,  $\text{CH}_2\text{CH}_2\text{-S}$ ), 32.70 (s,  $\text{CH}_2\text{CH}_2\text{-S}$ ), 33.15 (s,  $\text{CH}_2\text{CH}_2\text{-S}$ ), 39.66 (s,  $\text{S-CH}_2\text{-CH}$ ), 40.59 (s,  $\text{S-CH}_2\text{-CH}$ ), 70.12 (s,  $\text{CH-O}$ ), 70.97 (s,  $\text{CH-O}$ )

### Gallium tris[1,3-bis(<sup>t</sup>butylthio)propan-2-olate] (35):

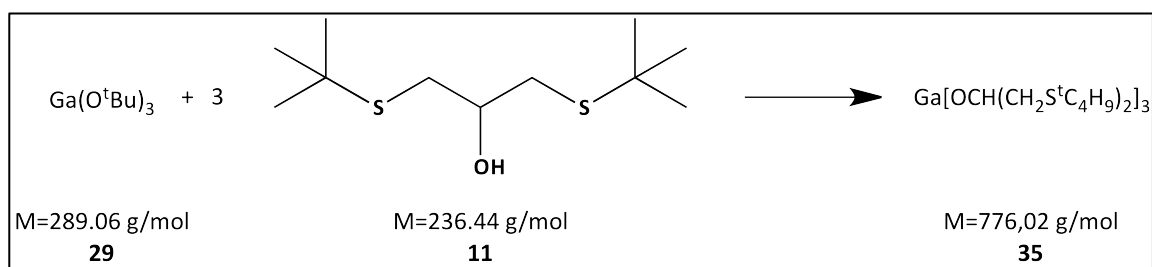

0.24 g (0.83 mmol, 1 equiv.)  $\text{Ga}(\text{O}^t\text{Bu})_3$  (**29**) were dissolved in 5 ml toluene and 0.64 g (2.70 mmol, 3.25 equiv.) of **11** were added. Ligand exchange occurred within 3 days at 50 °C. The volatile compounds were removed under reduced pressure. Minor residual tert.-butanolate impurities were removed by adding a few additional drops of the alcohol in 1 ml toluene to the alkoxide and heating to 80 °C for 4 h.

$^1\text{H}$  NMR ( $\text{CDCl}_3$ , 200 MHz,  $\delta$  [ppm]): 1.33 (s, 18H,  $\text{C}(\text{CH}_3)_3$ ), 2.58-3.18 (m, 4H,  $\text{S}-\text{CH}_2-\text{CH}$ ), 3.72-4.33 (m, 1H,  $\text{CH}-\text{O}$ )

$^{13}\text{C}$  { $^1\text{H}$ } NMR ( $\text{CDCl}_3$ , 62.86 MHz,  $\delta$  [ppm]): 31.22 (s,  $\text{C}(\text{CH}_3)_3$ ), 37.40 (s,  $\text{S}-\text{CH}_2-\text{C}$ ), 42.68 (s,  $\text{C}(\text{CH}_3)_3$ ), 71.48 (s,  $\text{CH}-\text{O}$ )

### Gallium tris[1-diethylamino-3-(isopropylthio)propan-2-olate] (36):

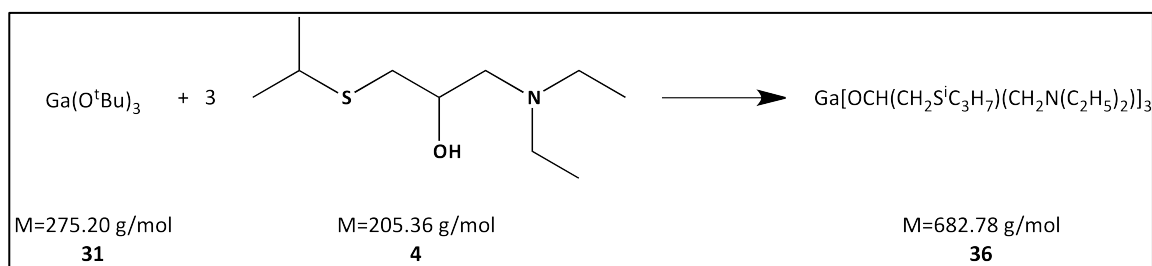

0.20 g (0.69 mmol, 1 equiv.)  $\text{Ga}(\text{O}^t\text{Bu})_3$  (**29**) were dissolved in 5 ml toluene and 0.55 g (2.67 mmol, 3.87 equiv.) of **4** were added. The ligand exchange was complete after 4 days at 50 °C. The volatile compounds were removed under reduced pressure.

$^1\text{H}$  NMR ( $\text{CDCl}_3$ , 200 MHz,  $\delta$  [ppm]): 1.01 (t,  $J=6.9$  Hz, 6H,  $\text{N}(\text{CH}_2\text{CH}_3)_2$ ), 1.22 (dd,  $J=6.63 / 2.78$  Hz, 6H,  $\text{CH}(\text{CH}_3)_2$ ), 2.17-2.84 (m, 8H,  $\text{S}-\text{CH}_2-\text{CH}$ ,  $\text{N}-\text{CH}_2-\text{CH}$ ,  $\text{N}(\text{CH}_2\text{CH}_3)_2$ ), 2.93 (m, 1H,  $\text{CH}(\text{CH}_3)_2$ ), 3.86 (m, 1H,  $\text{CH}-\text{O}$ )

$^{13}\text{C}$   $\{^1\text{H}\}$  NMR ( $\text{CDCl}_3$ , 62.86 MHz,  $\delta$  [ppm]): 9.33 (s,  $\text{N}(\text{CH}_2\text{CH}_3)_2$ ), 9.52 (s,  $\text{N}(\text{CH}_2\text{CH}_3)_2$ ), 10.01 (s,  $\text{N}(\text{CH}_2\text{CH}_3)_2$ ), 23.82 (s,  $\text{CH}(\text{CH}_3)_2$ ), 35.55 (s,  $\text{CH}(\text{CH}_3)_2$ ), 36.63 (s,  $\text{CH}(\text{CH}_3)_2$ ), 36.72 (s,  $\text{CH}(\text{CH}_3)_2$ ), 38.53 (s,  $\text{S-CH}_2\text{-CH}$ ), 38.59 (s,  $\text{S-CH}_2\text{-CH}$ ), 44.90 (s,  $\text{N}(\text{CH}_2\text{CH}_3)_2$ ), 45.15 (s,  $\text{N}(\text{CH}_2\text{CH}_3)_2$ ), 45.55 (s,  $\text{N}(\text{CH}_2\text{CH}_3)_2$ ), 59.26 (s,  $\text{N-CH}_2\text{-CH}$ ), 59.66 (s,  $\text{N-CH}_2\text{-CH}$ ), 69.01 (s,  $\text{CH-O}$ ), 69.38 (s,  $\text{CH-O}$ ), 69.98 (s,  $\text{CH-O}$ ),

### Gallium tris[1-<sup>n</sup>butylthio-3-(diethylamino)propan-2-olate] (37):

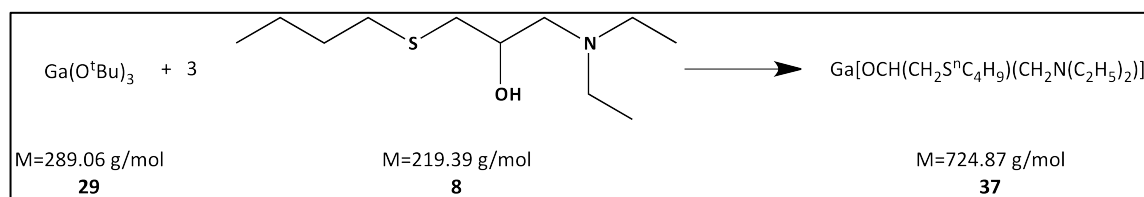

0.24 g (0.83 mmol, 1 equiv.)  $\text{Ga}(\text{O}^t\text{Bu})_3$  (**29**) were dissolved in 5 ml toluene and 0.67 g (3.06 mmol, 3.6 equiv.) of **8** were added. Ligand exchange occurred within 3 days at 50 °C. The volatile compounds were removed under reduced pressure to yield the viscous product.

$^1\text{H}$  NMR ( $\text{CDCl}_3$ , 200 MHz,  $\delta$  [ppm]): 0.89 (t,  $J=7.21$  Hz, 3H,  $\text{CH}_3\text{CH}_2\text{CH}_2$ ), 1.02 (t,  $J=6.32$  Hz, 6H,  $\text{N}(\text{CH}_2\text{CH}_3)_2$ ), 1.37 (m,  $J=7.22$  Hz, 2H,  $\text{CH}_3\text{CH}_2\text{CH}_2$ ), 1.54 (quint,  $J=7.23$ , 2H,  $\text{CH}_2\text{CH}_2\text{-S}$ ), 2.20-2.61 (m, 4H,  $\text{CH}_2\text{CH}_2\text{-S}$ ,  $\text{S-CH}_2\text{CH}$ ), 2.75 (m, 4H,  $\text{N}(\text{CH}_2\text{CH}_3)_2$ ), 3.88 (m, 1H,  $\text{CH-O}$ )

$^{13}\text{C}$   $\{^1\text{H}\}$  NMR ( $\text{CDCl}_3$ , 62.86 MHz,  $\delta$  [ppm]): 9.37 (s,  $\text{N}(\text{CH}_2\text{CH}_3)_2$ ), 9.52 (s,  $\text{N}(\text{CH}_2\text{CH}_3)_2$ ), 10.02 (s,  $\text{N}(\text{CH}_2\text{CH}_3)_2$ ), 13.84 (s,  $\text{CH}_3\text{CH}_2\text{CH}_2$ ), 22.15 (s,  $\text{CH}_3\text{CH}_2\text{CH}_2$ ), 32.28 (s,  $\text{CH}_2\text{CH}_2\text{-S}$ ), 33.03 (s,  $\text{CH}_2\text{CH}_2\text{-S}$ ), 33.09 (s,  $\text{CH}_2\text{CH}_2\text{-S}$ ), 40.33 (s,  $\text{S-CH}_2\text{-CH}$ ), 44.94 (s,  $\text{N}(\text{CH}_2\text{CH}_3)_2$ ), 45.17 (s,  $\text{N}(\text{CH}_2\text{CH}_3)_2$ ), 45.57 (s,  $\text{N}(\text{CH}_2\text{CH}_3)_2$ ), 59.22 (s,  $\text{N-CH}_2\text{-CH}$ ), 59.59 (s,  $\text{N-CH}_2\text{-CH}$ ), 68.98 (s,  $\text{CH-O}$ ), 69.41 (s,  $\text{CH-O}$ ), 69.86 (s,  $\text{CH-O}$ )

### Gallium tris[1-<sup>t</sup>butylthio-3-(diethylamino)propan-2-olate] (38):

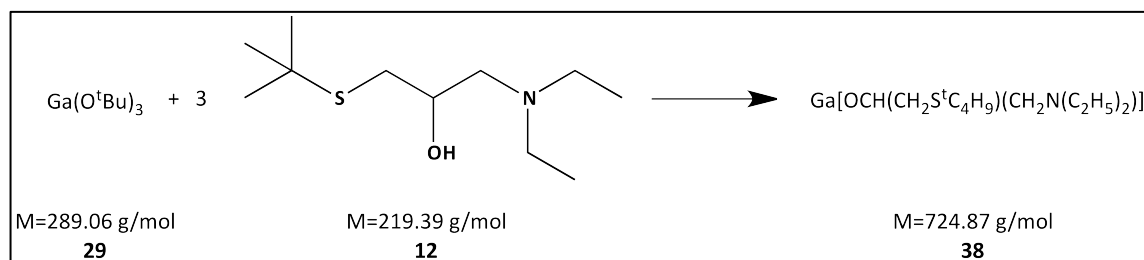

0.25 g (0.87 mmol, 1 equiv.)  $\text{Ga}(\text{O}^t\text{Bu})_3$  (**29**) were dissolved in 5 ml toluene and 0.65 g (2.96 mmol, 3.4 equiv.) of **12** were added. Ligand exchange occurred within 4 days at 60 °C. The volatile compounds were removed under reduced pressure to yield the viscous product.

**$^1\text{H}$  NMR ( $\text{CDCl}_3$ , 200 MHz,  $\delta$  [ppm]):** 1.02 (t,  $J=4.86$  Hz, 3H,  $\text{N}(\text{CH}_2\text{CH}_3)_2$ ), 1.29 (s, 9H,  $\text{C}(\text{CH}_3)_3$ ), 2.23-2.37 (m, 1H,  $\text{S}-\text{CH}_2-\text{CH}$ ), 2.44-2.61 (m, 1H,  $\text{S}-\text{CH}_2-\text{CH}$ ), 2.63-2.91 (m, 6H,  $\text{N}(\text{CH}_2\text{CH}_3)_2$ ),  $\text{N}-\text{CH}_2-\text{CH}$ ), 3.86 (m,  $J=7.1$  Hz, 1H,  $\text{CH}-\text{O}$ )

**$^{13}\text{C}$   $\{^1\text{H}\}$  NMR ( $\text{CDCl}_3$ , 62.86 MHz,  $\delta$  [ppm]):** 9.47 (s,  $\text{N}(\text{CH}_2\text{CH}_3)_2$ ), 9.98 (s,  $\text{N}(\text{CH}_2\text{CH}_3)_2$ ), 31.21 (s,  $\text{C}(\text{CH}_3)_3$ ), 36.41 (s,  $\text{S}-\text{CH}_2-\text{CH}$ ), 36.50 (s,  $\text{S}-\text{CH}_2-\text{CH}$ ), 41.59 (s,  $\text{C}(\text{CH}_3)_3$ ), 41.69 (s,  $\text{C}(\text{CH}_3)_3$ ), 44.91 (s,  $\text{N}(\text{CH}_2\text{CH}_3)_2$ ), 45.48 (s,  $\text{N}(\text{CH}_2\text{CH}_3)_2$ ), 59.39 (s,  $\text{N}-\text{CH}_2-\text{CH}$ ), 59.87 (s,  $\text{N}-\text{CH}_2-\text{CH}$ ), 68.75 (s,  $\text{CH}-\text{O}$ ), 69.00 (s,  $\text{CH}-\text{O}$ ), 69.49 (s,  $\text{CH}-\text{O}$ )

### Indium tris[1,3-bis(isopropylthio)propan-2-olate] (39):

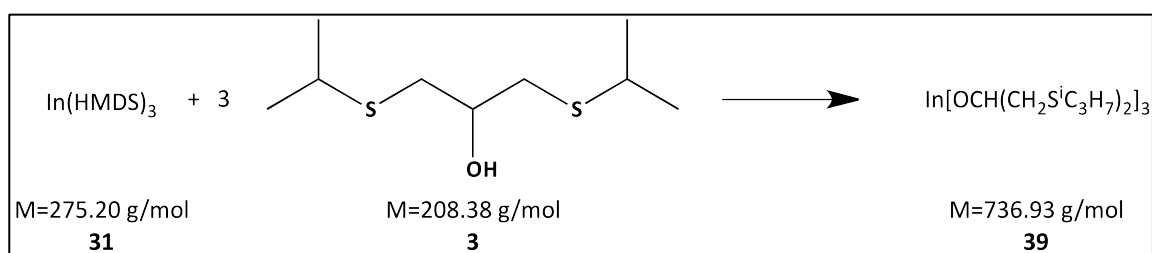

0.30 g (0.55 mmol, 1 equiv.)  $\text{In}(\text{HMDS})_3$  (**31**) were dissolved in 6 ml toluene before 0.41 g (1.97 mmol, 3.5 equiv.) of **3** were added. Ligand exchange occurred within 3 days at 50 °C. The volatile compounds were removed under reduced pressure to yield the viscous product.

**$^1\text{H}$  NMR ( $\text{CDCl}_3$ , 200 MHz,  $\delta$  [ppm]):** 1.22-1.38 (m, 6H,  $\text{CH}(\text{CH}_3)_2$ ), 2.72-2.95 (m, 2H,  $\text{S}-\text{CH}_2-\text{CH}$ ), 3.10 (m,  $J=6.44$  Hz, 2H,  $\text{CH}(\text{CH}_3)_2$ ), 4.14 (quint,  $J=5.47$  Hz, 1H,  $\text{CH}-\text{O}$ )

**$^{13}\text{C}$   $\{^1\text{H}\}$  NMR ( $\text{CDCl}_3$ , 62.86 MHz,  $\delta$  [ppm]):** 23.58 (s,  $\text{CH}(\text{CH}_3)_2$ ), 23.82 (s,  $\text{CH}(\text{CH}_3)_2$ ), 45.67 (s,  $\text{CH}(\text{CH}_3)_2$ ), 39.28 (s,  $\text{S}-\text{CH}_2-\text{CH}$ ), 69.94 (s,  $\text{CH}-\text{O}$ )

### Indium tris[1,3-bis( $n$ butylthio)propan-2-olate] (40):

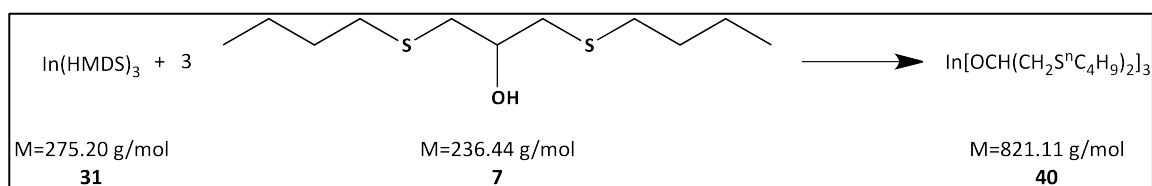

0.33 g (0.60 mmol, 1 equiv.)  $\text{In}(\text{HMDS})_3$  (**31**) were dissolved in 6 ml toluene before 0.48 g (2.03 mmol, 3.38 equiv.) of **7** were added. Ligand exchange occurred within 3 days at 50 °C. The volatile compounds were removed under reduced pressure to yield viscous product.

$^1\text{H}$  NMR ( $\text{CDCl}_3$ , 200 MHz,  $\delta$  [ppm]): 0.91 (t,  $J=7.15$  Hz, 6H,  $\text{CH}_3\text{CH}_2\text{CH}_2$ ), 1.41 (m,  $J=7.32$  Hz, 4H,  $\text{CH}_3\text{CH}_2\text{CH}_2$ ), 1.58 (quint,  $J=7.23$  Hz, 4H,  $\text{CH}_2\text{CH}_2\text{-S}$ ), 2.63 (t,  $J=7.32$  Hz, 4H,  $\text{CH}_2\text{CH}_2\text{-S}$ ), 2.71-2.91 (m, 4H,  $\text{S-CH}_2\text{-CH}$ ), 4.04 (m,  $J=5.62$  Hz, 1H,  $\text{CH-O}$ )

$^{13}\text{C}$   $\{^1\text{H}\}$  NMR ( $\text{CDCl}_3$ , 62.86 MHz,  $\delta$  [ppm]): 13.89 (s,  $\text{C-CH}_3\text{CH}_2\text{CH}_2$ ), 22.15 (s,  $\text{CH}_3\text{-CH}_2\text{CH}_2$ ), 31.90 (s,  $\text{CH}_2\text{CH}_2\text{-S}$ ), 32.58 (s,  $\text{CH}_2\text{CH}_2\text{-S}$ ), 40.69 (s,  $\text{S-CH}_2\text{-CH}$ ), 69.28 (s,  $\text{CH-O}$ )

### Indium tris[1,3-bis(<sup>t</sup>butylthio)propan-2-olate] (41):

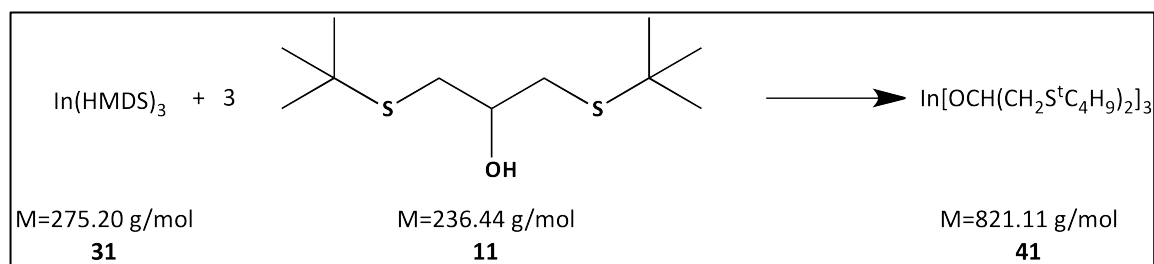

0.29 g (0.53 mmol, 1 equiv.)  $\text{In}(\text{HMDS})_3$  (**31**) were dissolved in 5 ml toluene before 0.43 g (1.82 mmol, 3.43 equiv.) of **11** were added. Ligand exchange occurred within 3 days at 50 °C. The volatile compounds were removed under reduced pressure to yield viscous product.

$^1\text{H}$  NMR ( $\text{CDCl}_3$ , 200 MHz,  $\delta$  [ppm]): 1.35 (s, 18H,  $\text{C}(\text{CH}_3)_3$ ), 2.56-3.04 (m, 4H,  $\text{S-CH}_2\text{-C}$ ), 4.27-4.41 (m, 1H,  $\text{CH-O}$ )

$^{13}\text{C}$   $\{^1\text{H}\}$  NMR ( $\text{CDCl}_3$ , 62.86 MHz,  $\delta$  [ppm]): 31.44 (s,  $\text{C}(\text{CH}_3)_3$ ), 36.92 (s,  $\text{S-CH}_2\text{-CH}$ ), 43.08 (s,  $\text{C}(\text{CH}_3)_3$ ), 70.73 (s,  $\text{CH-O}$ )

### Indium tris[1-diethylamino-3-(isopropylthio)propan-2-olate] (42):

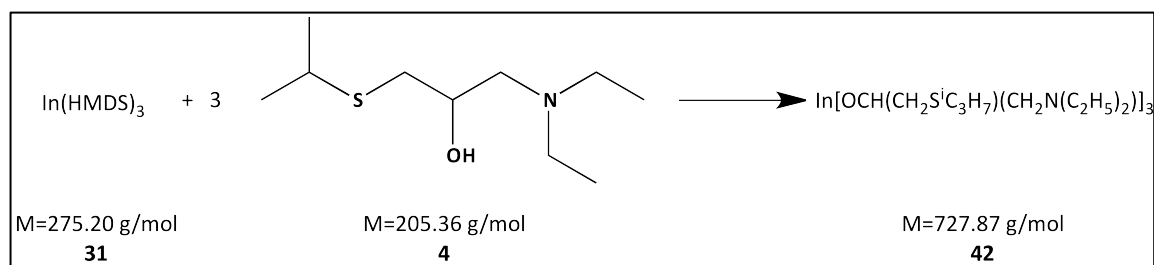

0.34 g (0.63 mmol, 1 equiv.)  $\text{In}(\text{HMDS})_3$  (**31**) were dissolved in 5 ml toluene before 0.40 g (1.95 mmol, 3.1 equiv.) of **4** were added. Ligand exchange occurred within 4 days at 50 °C. The volatile compounds were removed under reduced pressure to yield viscous product.



**$^1\text{H}$  NMR ( $\text{CDCl}_3$ , 200 MHz,  $\delta$  [ppm]):** 1.02 (t,  $J=7.98$  Hz, 6H,  $\text{N}(\text{CH}_2\text{CH}_3)_2$ ), 1.24 (dd,  $J=3.78 / 6.80$  Hz, 6H,  $\text{CH}(\text{CH}_3)_2$ ), 2.20-2.35 (m, 1H,  $\text{S}-\text{CH}_2-\text{CH}$ ), 2.47-2.84 (m, 7H,  $\text{S}-\text{CH}_2-\text{CH}$ ,  $\text{N}-\text{CH}_2-\text{CH}$ ,  $\text{N}(\text{CH}_2\text{CH}_3)_2$ ), 2.97 (m,  $J=6.67$  Hz, 1H,  $\text{CH}(\text{CH}_3)_2$ ), 3.85 (m, 1H,  $\text{CH}-\text{O}$ )

**$^{13}\text{C}$   $\{^1\text{H}\}$  NMR ( $\text{CDCl}_3$ , 62.86 MHz,  $\delta$  [ppm]):** 9.60 (s,  $\text{N}(\text{CH}_2\text{CH}_3)_2$ ), 9.97 (s,  $\text{N}(\text{CH}_2\text{CH}_3)_2$ ), 23.79 (s,  $\text{CH}(\text{CH}_3)_2$ ), 35.72 (s,  $\text{CH}(\text{CH}_3)_2$ ), 39.31 (s,  $\text{S}-\text{CH}_2-\text{CH}$ ), 45.52 (s,  $\text{N}(\text{CH}_2\text{CH}_3)_2$ ), 45.93 (s,  $\text{N}(\text{CH}_2\text{CH}_3)_2$ ), 60.98 (s,  $\text{N}-\text{CH}_2-\text{CH}$ ), 61.33 (s,  $\text{N}-\text{CH}_2-\text{CH}$ ), 69.61 (s,  $\text{CH}-\text{O}$ ), 69.78 (s,  $\text{CH}-\text{O}$ ), 70.19 (s,  $\text{CH}-\text{O}$ )

### Indium tris[1-<sup>n</sup>butylthio-3-(diethylamino)propan-2-olate] (43):

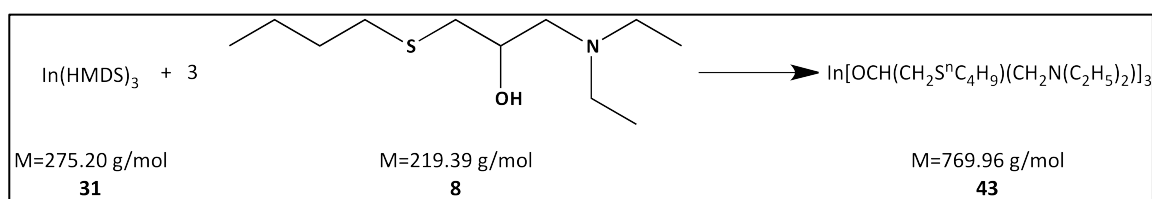

0.36 g (0.66 mmol, 1 equiv.)  $\text{In}(\text{HMDS})_3$  (**31**) were dissolved in 5 ml toluene before 0.45 g (2.05 mmol, 3.1 equiv.) of **8** were added. Ligand exchange occurred within 4 days at 50 °C. The volatile compounds were removed under reduced pressure to yield viscous product.

**$^1\text{H}$  NMR ( $\text{CDCl}_3$ , 200 MHz,  $\delta$  [ppm]):** 0.90 (t,  $J=7.15$  Hz, 3H,  $\text{CH}_3\text{CH}_2\text{CH}_2$ ), 1.06 (t,  $J=7.02$  Hz, 6H,  $\text{N}(\text{CH}_2\text{CH}_3)_2$ ), 1.38 (m,  $J=7.08$  Hz, 2H,  $\text{CH}_3\text{CH}_2\text{CH}_2$ ), 1.56 (quint.,  $J=7.46$  Hz, 2H,  $\text{CH}_2\text{CH}_2-\text{S}$ ), 2.19-2.69 (m, 4H,  $\text{S}-\text{CH}_2-\text{CH}$ ,  $\text{CH}_2\text{CH}_2-\text{S}$ ), 2.70-3.04 (m, 6H,  $\text{N}(\text{CH}_2\text{CH}_3)_2$ ,  $\text{N}-\text{CH}_2-\text{CH}$ ), 3.93 (m, 1H,  $\text{CH}-\text{O}$ )

**$^{13}\text{C}$   $\{^1\text{H}\}$  NMR ( $\text{CDCl}_3$ , 62.86 MHz,  $\delta$  [ppm]):** 9.64 (s,  $\text{N}(\text{CH}_2\text{CH}_3)_2$ ), 9.73 (s,  $\text{N}(\text{CH}_2\text{CH}_3)_2$ ), 10.05 (s,  $\text{N}(\text{CH}_2\text{CH}_3)_2$ ), 13.88 (s,  $\text{CH}_3\text{CH}_2\text{CH}_2$ ), 22.19 (s,  $\text{CH}_3\text{CH}_2\text{CH}_2$ ), 32.12 (s,  $\text{CH}_2\text{CH}_2-\text{S}$ ), 33.14 (s,  $\text{CH}_2\text{CH}_2-\text{S}$ ), 33.22 (s,  $\text{CH}_2\text{CH}_2-\text{S}$ ), 41.10 (s,  $\text{S}-\text{CH}_2-\text{CH}$ ), 45.60 (s,  $\text{N}(\text{CH}_2\text{CH}_3)_2$ ), 46.03 (s,  $\text{N}(\text{CH}_2\text{CH}_3)_2$ ), 60.94 (s,  $\text{N}-\text{CH}_2-\text{CH}$ ), 61.29 (s,  $\text{N}-\text{CH}_2-\text{CH}$ ), 69.44 (s,  $\text{CH}-\text{O}$ ), 69.70 (s,  $\text{CH}-\text{O}$ ), 69.94 (s,  $\text{CH}-\text{O}$ )

### Indium tris[1-<sup>t</sup>butylthio-3-(diethylamino)propan-2-olate] (44):

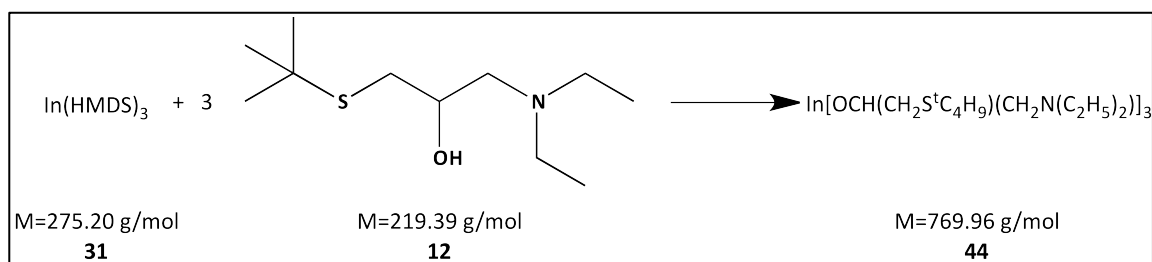

0.31 g (0.57 mmol, 1 equiv.)  $\text{In}(\text{HMDS})_3$  (**31**) were dissolved in 5 ml toluene before 0.47 g (2.14 mmol, 3.75 equiv.) of **12** were added. Ligand exchange occurred within 3 days at 50 °C. The volatile compounds were removed under reduced pressure to yield viscous product.

$^1\text{H}$  NMR ( $\text{CDCl}_3$ , 200 MHz,  $\delta$  [ppm]): 1.01 (t,  $J=6.85$  Hz, 6H,  $\text{N}(\text{CH}_2\text{CH}_3)_2$ ), 1.27 (s, 9H,  $\text{C}(\text{CH}_3)_3$ ), 2.25 (q,  $J=10.23$  Hz, 1H, S- $\text{CH}_2$ -CH), 2.45-2.60 (m, 1H, S- $\text{CH}_2$ -CH), 2.65-2.90 (m, 6H, N- $\text{CH}_2$ -CH,  $\text{N}(\text{CH}_2\text{CH}_3)_2$ ), 3.88 (m,  $J=3.6$  Hz, 1H,  $\text{CH-O}$ )

$^{13}\text{C}$  { $^1\text{H}$ } NMR ( $\text{CDCl}_3$ , 62.86 MHz,  $\delta$  [ppm]): 9.66 (s,  $\text{N}(\text{CH}_2\text{CH}_3)_2$ ), 9.98 (s,  $\text{N}(\text{CH}_2\text{CH}_3)_2$ ), 31.18 (s,  $\text{C}(\text{CH}_3)_3$ ), 37.15 (s, S- $\text{CH}_2$ -CH), 41.78 (s,  $\text{C}(\text{CH}_3)_3$ ), 45.48 (s,  $\text{N}(\text{CH}_2\text{CH}_3)_2$ ), 45.88 (s,  $\text{N}(\text{CH}_2\text{CH}_3)_2$ ), 61.00 (s, N- $\text{CH}_2$ -CH), 61.40 (s, N- $\text{CH}_2$ -CH), 69.29 (s,  $\text{CH-O}$ ), 69.85 (s,  $\text{CH-O}$ )

### Gallium tris[1-ethoxy-2-((ethoxy)methyl)butan-2-olate] (**45**):

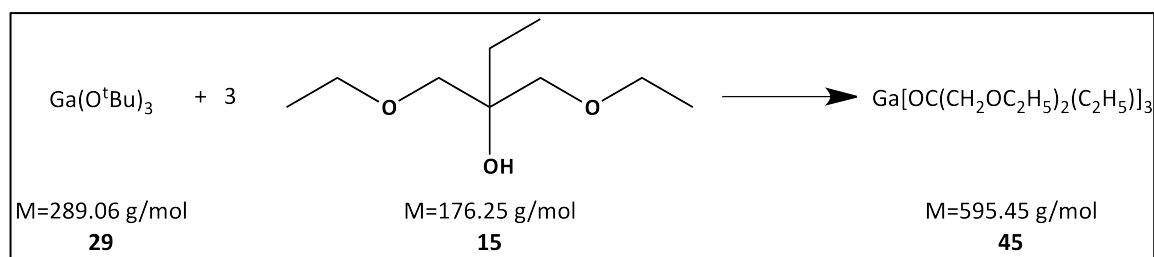

0.34 g (1.19 mmol, 1 equiv.)  $\text{Ga}(\text{O}^t\text{Bu})_3$  (**29**) were dissolved in 5 ml of toluene and 0.650 g (3.61 mmol, 3.1 equiv.) of **15** were added. After stirring over night, all volatile parts were removed at reduced pressure and a small amount of the alcohol in 1 ml toluene was added. After one day, the exchange was complete and all volatiles were removed yielding a clear, non-viscous liquid.

$^1\text{H}$  NMR ( $\text{CDCl}_3$ , 200 MHz,  $\delta$  [ppm]): 0.89 (t,  $J=7.41$  Hz, 3H, C- $\text{CH}_2\text{CH}_3$ ), 1.20 (t,  $J=7.04$  Hz, 6H, O- $\text{CH}_2\text{CH}_3$ ), 1.46 (q,  $J=7.45$  Hz, 2H, C- $\text{CH}_2\text{CH}_3$ ), 3.21-3.41 (m, 4H, O- $\text{CH}_2\text{CH}_3$ ), 3.49-3.73 (m, 4H, O- $\text{CH}_2$ -C)

$^{13}\text{C}$  { $^1\text{H}$ } NMR ( $\text{CDCl}_3$ , 62.86 MHz,  $\delta$  [ppm]): 7.46 (s, C- $\text{CH}_2\text{CH}_3$ ), 14.96 (s, O- $\text{CH}_2\text{CH}_3$ ), 29.41 (s, C- $\text{CH}_2\text{CH}_3$ ), 67.15 (s, O- $\text{CH}_2\text{CH}_3$ ), 74.45 (s, O- $\text{CH}_2$ -C), 74.14 (s,  $\text{C-O}$ )

### Gallium tris[1-ethylthio-2-((ethylthio)methyl)butan-2-olate] (46):

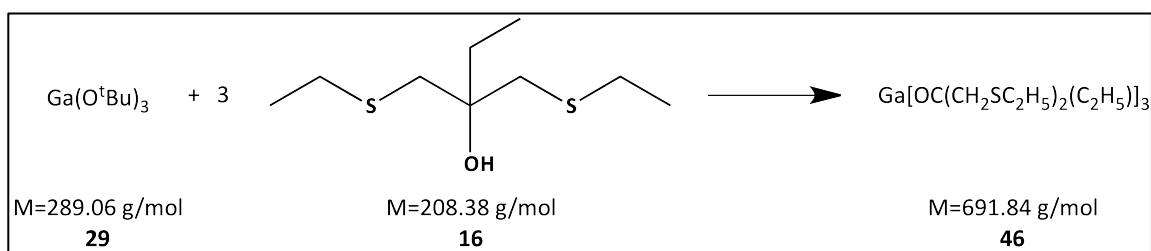

0.42 g (1.45 mmol, 1 equiv.)  $\text{Ga}(\text{O}^t\text{Bu})_3$  (**29**) were dissolved in ca. 5 ml toluene before adding 0.94 g (4.48 mmol, 3.1 equiv.) of **16** at room temperature. After 5.5 h, a  $^1\text{H}$  NMR spectrum showed residual tert.-butanolate signals and the volume of the mixture was reduced to one third at reduced pressure. After a few days at room temperature all volatile substances were removed by vacuum and a few drops of the ligand added in 2 ml toluene. Stirring over night at 50 °C resulted in a complete exchange of the ligands and all volatile parts were removed under reduced pressure to yield a clear yellowish liquid.

$^1\text{H}$  NMR ( $\text{CDCl}_3$ , 200 MHz,  $\delta$  [ppm]): 0.91 (t,  $J=7.34$  Hz, 3H, C- $\text{CH}_2\text{CH}_3$ ), 1.27 (t,  $J=7.38$  Hz, 6H, S- $\text{CH}_2\text{CH}_3$ ), 1.60 (q,  $J=7.21$  Hz, 2H, C- $\text{CH}_2\text{CH}_3$ ), 2.50-2.90 (m, 6H, S- $\text{CH}_2\text{-C}$ , S- $\text{CH}_2\text{CH}_3$ )

$^{13}\text{C}$  { $^1\text{H}$ } NMR ( $\text{CDCl}_3$ , 62.86 MHz,  $\delta$  [ppm]): 8.48 (s, C- $\text{CH}_2\text{CH}_3$ ), 14.99 (s, S- $\text{CH}_2\text{CH}_3$ ), 28.38 (s, S- $\text{CH}_2\text{CH}_3$ ), 33.40 (s, C- $\text{CH}_2\text{CH}_3$ ), 43.05 (s, S- $\text{CH}_2\text{-C}$ ), 75.83 (s, C-O)

### Gallium tris [1-isopropylthio-2-((isopropylthio)methyl)butan-2-olate] (47):

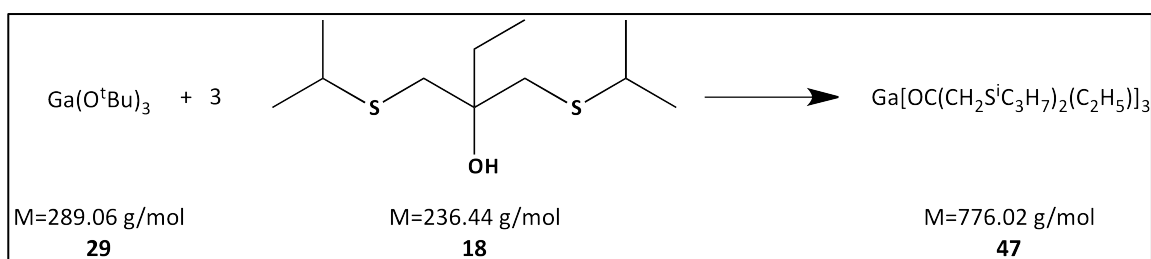

0.32 g (1.11 mmol, 1 equiv.)  $\text{Ga}(\text{O}^t\text{Bu})_3$  (**29**) were dissolved in 5 ml toluene before adding 0.81 g (3.44 mmol, 3.1 equiv.) of **18**. After one week at room temperature, the reaction's volume was reduced to 50 % at reduced pressure and the residual solution stirred for another 4 h at 50 °C. A visible solid in the solution was removed via filtration before removing all volatiles to yield a clear liquid.

$^1\text{H}$  NMR ( $\text{CDCl}_3$ , 200 MHz,  $\delta$  [ppm]): 0.91 (t,  $J=7.27$  Hz, 3H, C- $\text{CH}_2\text{CH}_3$ ), 1.28 (d,  $J=6.69$  Hz, 12H,  $\text{CH}(\text{CH}_3)_2$ ), 1.58 (q,  $J=7.38$ , 2H, C- $\text{CH}_2\text{CH}_3$ ), 2.61-2.91 (m, 4H, S- $\text{CH}_2\text{-C}$ ), 3.05 (m,  $J=6.64$  Hz, 2H,  $\text{CH}(\text{CH}_3)_2$ )

$^{13}\text{C}$   $\{^1\text{H}\}$  NMR ( $\text{CDCl}_3$ , 62.86 MHz,  $\delta$  [ppm]): 8.40 (s, C- $\text{CH}_2\text{CH}_3$ ), 23.61 (d,  $J=3.56$  Hz,  $\text{CH}(\text{CH}_3)_2$ ), 33.51 (s, C- $\text{CH}_2\text{CH}_3$ ), 37.27 (s,  $\text{CH}(\text{CH}_3)_2$ ), 42.00 (s, S- $\text{CH}_2\text{-C}$ ), 75.68 (s, C-O)

### Gallium tris[1- $n$ -butylthio-2-(( $n$ -butylthio)methyl)butan-2-olate] (48):

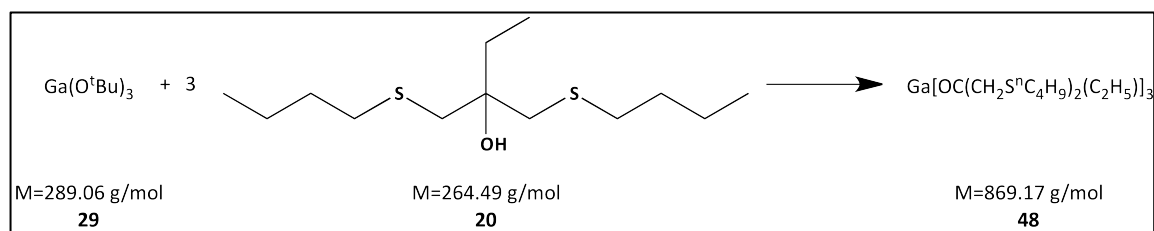

0.93 g (3.5 mmol, 3.1 equiv.) of **20** were added to a solution of 0.326 g (1.13 mmol, 1 equiv.)  $\text{Ga}(\text{O}^t\text{Bu})_3$  (**29**) in 5-6 ml toluene. After stirring for 5 h at room temperature, the solution's volume was reduced to a third and stirred at 50 °C for 2 d before removing all volatiles.

$^1\text{H}$  NMR ( $\text{CDCl}_3$ , 200 MHz,  $\delta$  [ppm]): 0.85-0.97 (m, 9H, C- $\text{CH}_2\text{CH}_3$ ,  $\text{CH}_3\text{CH}_2\text{CH}_2$ ), 1.31-1.49 (m, 4H,  $\text{CH}_3\text{CH}_2\text{CH}_2$ ), 1.50-1.68 (m, 6H,  $\text{CH}_2\text{CH}_2\text{-S}$ , C- $\text{CH}_2\text{CH}_3$ ), 2.49-2.94 (m, 8H,  $\text{CH}_2\text{CH}_2\text{-S}$ , S- $\text{CH}_2\text{-C}$ )

$^{13}\text{C}$   $\{^1\text{H}\}$  NMR ( $\text{CDCl}_3$ , 62.86 MHz,  $\delta$  [ppm]): 8.43 (s, C- $\text{CH}_2\text{CH}_3$ ), 13.83 (s,  $\text{CH}_3\text{CH}_2\text{CH}_2$ ), 22.19 (s,  $\text{CH}_3\text{CH}_2\text{CH}_2$ ), 31.76 (s,  $\text{CH}_2\text{CH}_2\text{-S}$ ), 32.01 (s,  $\text{CH}_2\text{CH}_2\text{-S}$ ), 32.22 (s,  $\text{CH}_2\text{CH}_2\text{-S}$ ), 33.05 (s, C- $\text{CH}_2\text{CH}_3$ ), 33.40 (s, C- $\text{CH}_2\text{CH}_3$ ), 33.44 (s, C- $\text{CH}_2\text{CH}_3$ ), 34.12 (s,  $\text{CH}_2\text{CH}_2\text{-S}$ ), 34.38 (s,  $\text{CH}_2\text{CH}_2\text{-S}$ ), 43.41 (s, S- $\text{CH}_2\text{-C}$ ), 43.76 (s, S- $\text{CH}_2\text{-C}$ ), 74.66 (s, C-O), 75.80 (s, C-O)

### Gallium tris[1- $t$ -butylthio-2-(( $t$ -butylthio)methyl)butan-2-olate] (49):

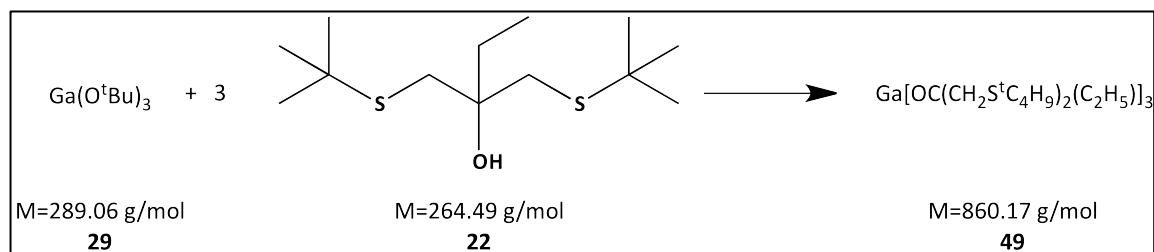

0.32 g (1.1 mmol, 1 equiv.)  $\text{Ga}(\text{O}^t\text{Bu})_3$  (**29**) were dissolved in 5 ml toluene before adding 0.91 g (3.43 mmol, 3.1 equiv.) of **22**. After 1 week at room temperature, the volume was

reduced to 50 % and the solution stirred at 50 °C for 4 h. After filtering, all volatile compounds were removed at reduced pressure before adding a few drops of the ligand in 1 ml toluene and stirring over night at 50 °C. Since little amounts of the initial tert.-butanole groups were still present according to NMR, the last step was repeated once more to shift the equilibrium towards the product. After removing all volatiles, a yellowish clear liquid was obtained.

**$^1\text{H}$  NMR (CDCl<sub>3</sub>, 200 MHz,  $\delta$  [ppm]):** 0.81-1.04 (m, 3H, C-CH<sub>2</sub>CH<sub>3</sub>), 1.30 (s, 12 H, C(CH<sub>3</sub>)<sub>3</sub>), 1.39 (s, 6H, C(CH<sub>3</sub>)<sub>3</sub>), 1.49-1.67 (m, 2H, C-CH<sub>2</sub>CH<sub>3</sub>), 2.50-3.05 (m, 4H, S-CH<sub>2</sub>-C)

**$^{13}\text{C}$  { $^1\text{H}$ } NMR (CDCl<sub>3</sub>, 62.86 MHz,  $\delta$  [ppm]):** 8.13 (s, C-CH<sub>2</sub>CH<sub>3</sub>), 31.33 (s, C(CH<sub>3</sub>)<sub>3</sub>), 36.31 (s, C-CH<sub>2</sub>CH<sub>3</sub>), 38.88 (s, S-CH<sub>2</sub>-C), 44.6 (s, C(CH<sub>3</sub>)<sub>3</sub>), 74.37 (s, C-O)

### Gallium tris[1-diethylamino-2-((ethylthio)methyl)butan-2-olate] (50)

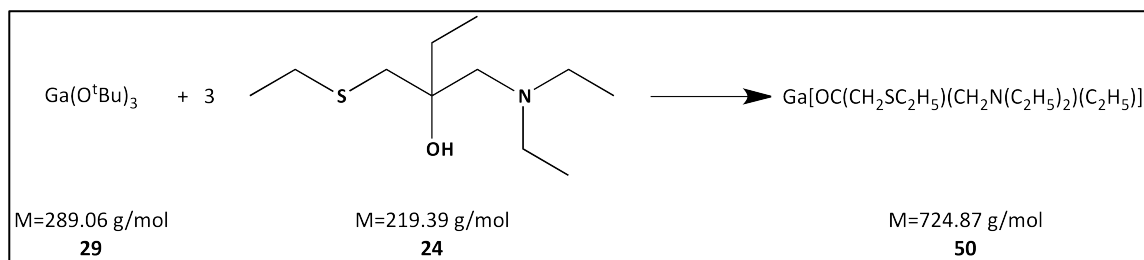

0.30 g (1.05 mmol, 1 equiv.) Ga(O<sup>t</sup>Bu)<sub>3</sub> (**29**) were dissolved in 5 ml toluene and 0.71 g (3.25 mmol, 3.1 equiv.) of **24** were added. Ligand exchange has proven to be rather slow, so the volatiles were removed over and over while adding few drops of alcohol and fresh toluene. After four to five weeks at 55 °C the exchange was complete and all volatiles were removed.

**$^1\text{H}$  NMR (CDCl<sub>3</sub>, 200 MHz,  $\delta$  [ppm]):** 0.91 (t, J=7.15 Hz, 3H, C-CH<sub>2</sub>CH<sub>3</sub>), 1.01 (t, J=6.94 Hz, 6H, N(CH<sub>2</sub>CH<sub>3</sub>)<sub>2</sub>), 1.23 (t, J=7.31 Hz, 3H, S-CH<sub>2</sub>CH<sub>3</sub>), 1.39-1.73 (m, 2H, C-CH<sub>2</sub>CH<sub>3</sub>), 2.35-2.61 (m, 4H, S-CH<sub>2</sub>CH<sub>3</sub>, S-CH<sub>2</sub>-C), 2.62-2.91 (m, 6H, N(CH<sub>2</sub>CH<sub>3</sub>)<sub>2</sub>), N-CH<sub>2</sub>-C)

**$^{13}\text{C}$  { $^1\text{H}$ } NMR (CDCl<sub>3</sub>, 62.86 MHz,  $\delta$  [ppm]):** 8.29 (s, C-CH<sub>2</sub>CH<sub>3</sub>), 8.54 (s, C-CH<sub>2</sub>CH<sub>3</sub>), 9.75 (s, N(CH<sub>2</sub>CH<sub>3</sub>)<sub>2</sub>), 9.88 (s, N(CH<sub>2</sub>CH<sub>3</sub>)<sub>2</sub>), 15.16 (s, S-CH<sub>2</sub>CH<sub>3</sub>), 27.87 (s, S-CH<sub>2</sub>CH<sub>3</sub>), 33.45 (s, C-CH<sub>2</sub>CH<sub>3</sub>), 34.34 (s, C-CH<sub>2</sub>CH<sub>3</sub>), 42.81 (s, S-CH<sub>2</sub>-C), 42.94 (s, S-CH<sub>2</sub>-C), 46.58 (s, N(CH<sub>2</sub>CH<sub>3</sub>)<sub>2</sub>), 46.69 (s, N(CH<sub>2</sub>CH<sub>3</sub>)<sub>2</sub>), 61.71 (s, N-CH<sub>2</sub>-C), 61.77 (s, N-CH<sub>2</sub>-C), 61.92 (s, N-CH<sub>2</sub>-C), 74.47 (s, C-O), 74.72 (s, C-O)

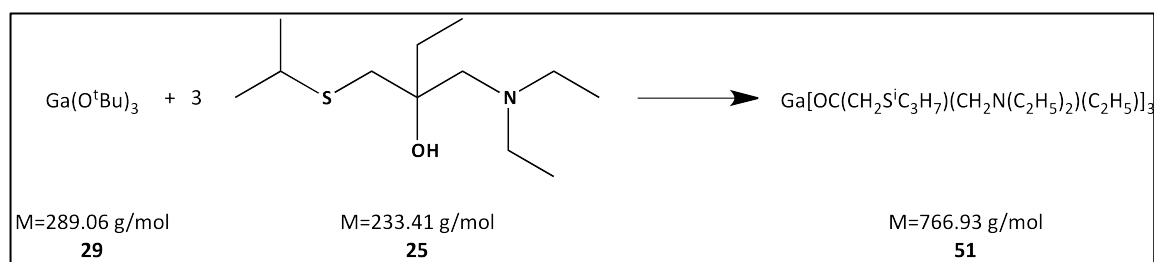
**Gallium tris [1-diethylamino-2-((isopropylthio)methyl)butan-2-olate] (51):**

The ligand exchange reaction was carried out similar to the ethyl analogue (**50**) using 0.31 g (1.06 mmol, 1 equiv.)  $\text{Ga}(\text{O}^t\text{Bu})_3$  (**29**) and 0.77 g (3.27 mmol, 1 equiv.) of **25**.

**$^1\text{H}$  NMR ( $\text{CDCl}_3$ , 200 MHz,  $\delta$  [ppm]):** 0.92 (t,  $J=6.74$  Hz, 3H, C- $\text{CH}_2\text{CH}_3$ ), 1.02 (t,  $J=6.98$  Hz, 5H,  $\text{N}(\text{CH}_2\text{CH}_3)_2$ ), 1.15 (m, 1H,  $\text{N}(\text{CH}_2\text{CH}_3)_2$ ), 1.25 (d,  $J=6.63$  Hz, 6H,  $\text{CH}(\text{CH}_3)_2$ ), 1.50-1.58 (m, 2H, C- $\text{CH}_2\text{CH}_3$ ), 2.45-2.99 (m, 9H, S- $\text{CH}_2\text{-C}$ ,  $\text{CH}(\text{CH}_3)_2$ ,  $\text{N}(\text{CH}_2\text{CH}_3)_2$ , N- $\text{CH}_2\text{-C}$ )

**$^{13}\text{C}$   $\{^1\text{H}\}$  NMR ( $\text{CDCl}_3$ , 62.86 MHz,  $\delta$  [ppm]):** 8.43 (s, C- $\text{CH}_2\text{CH}_3$ ), 8.48 (s, C- $\text{CH}_2\text{CH}_3$ ), 8.54 (s, C- $\text{CH}_2\text{CH}_3$ ), 9.73 (s,  $\text{N}(\text{CH}_2\text{CH}_3)_2$ ), 9.83 (s,  $\text{N}(\text{CH}_2\text{CH}_3)_2$ ), 9.88 (s,  $\text{N}(\text{CH}_2\text{CH}_3)_2$ ), 23.83 (s,  $\text{CH}(\text{CH}_3)_2$ ), 33.62 (s, C- $\text{CH}_2\text{CH}_3$ ), 33.95 (s, C- $\text{CH}_2\text{CH}_3$ ), 36.16 (s,  $\text{CH}(\text{CH}_3)_2$ ), 36.47 (s,  $\text{CH}(\text{CH}_3)_2$ ), 41.48 (s, S- $\text{CH}_2\text{-C}$ ), 41.59 (s, S- $\text{CH}_2\text{-C}$ ), 46.54 (s,  $\text{N}(\text{CH}_2\text{CH}_3)_2$ ), 46.63 (s,  $\text{N}(\text{CH}_2\text{CH}_3)_2$ ), 46.68 (s,  $\text{N}(\text{CH}_2\text{CH}_3)_2$ ), 61.84 (s, N- $\text{CH}_2\text{-C}$ ), 61.91 (s, N- $\text{CH}_2\text{-C}$ ), 62.09 (s, N- $\text{CH}_2\text{-C}$ ), 74.30 (s,  $\text{C-O}$ ), 74.59 (s,  $\text{C-O}$ )

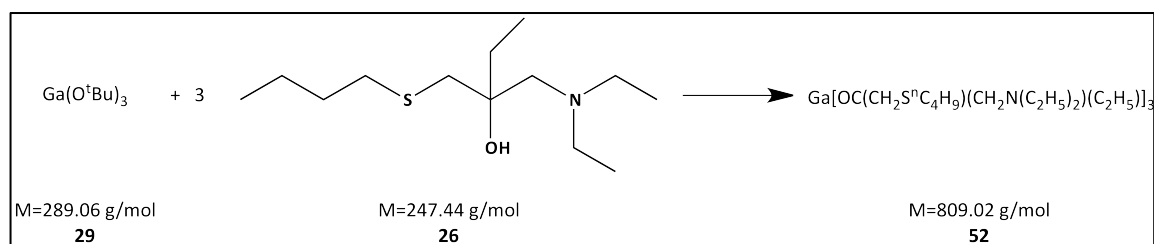
**Gallium tris[1-<sup>n</sup>butylthio-2-((diethylamino)methyl)butan-2-olate] (52)**

The ligand exchange reaction was carried out similar to the ethyl analogue (**50**) using 0.35 g (1.22 mmol, 1 equiv.) of  $\text{Ga}(\text{O}^t\text{Bu})_3$  (**29**) and 0.94 g (3.79 mmol, 3.1 equiv.) of **26**.

**$^1\text{H}$  NMR ( $\text{CDCl}_3$ , 200 MHz,  $\delta$  [ppm]):** 0.90 (t,  $J=7.01$  Hz, 6H, C- $\text{CH}_2\text{CH}_3$ ,  $\text{CH}_3\text{CH}_2\text{CH}_2$ ), 0.96-1.08 (m, 6H,  $\text{N}(\text{CH}_2\text{CH}_3)_2$ ), 1.31-1.46 (m, 3H, C- $\text{CH}_2\text{CH}_3$ ,  $\text{CH}_3\text{CH}_2\text{CH}_2$ ), 1.47-1.67 (m, 3H, C- $\text{CH}_2\text{CH}_3$ ,  $\text{CH}_2\text{CH}_2\text{-S}$ ), 2.15-2.36 (m, 1H, S- $\text{CH}_2\text{-C}$ ), 2.37-2.56 (m, S- $\text{CH}_2\text{-C}$ ,  $\text{CH}_2\text{CH}_2\text{-S}$ ), 2.56-3.09 (m, 6H, N- $\text{CH}_2\text{-C}$ ,  $\text{N}(\text{CH}_2\text{CH}_3)_2$ )

**$^{13}\text{C}$   $\{^1\text{H}\}$  NMR ( $\text{CDCl}_3$ , 62.86 MHz,  $\delta$  [ppm]):** 8.20 (s, C- $\text{CH}_2\text{CH}_3$ ), 8.52 (s, C- $\text{CH}_2\text{CH}_3$ ), 8.58 (s, C- $\text{CH}_2\text{CH}_3$ ), 9.26 (s,  $\text{N}(\text{CH}_2\text{CH}_3)_2$ ), 9.79 (s,  $\text{N}(\text{CH}_2\text{CH}_3)_2$ ), 9.91 (s,  $\text{N}(\text{CH}_2\text{CH}_3)_2$ ), 13.88

(s,  $\underline{\text{C}}\text{H}_3\text{CH}_2\text{CH}_2$ ), 22.17 (s,  $\text{CH}_3\underline{\text{C}}\text{H}_2\text{CH}_2$ ), 22.26 (s,  $\text{CH}_3\underline{\text{C}}\text{H}_2\text{CH}_2$ ), 32.20 (s,  $\underline{\text{C}}\text{H}_2\text{CH}_2\text{-S}$ ), 33.47 (s,  $\text{CH}_2\underline{\text{C}}\text{H}_2\text{-S}$ ), 33.54 (s,  $\text{CH}_2\underline{\text{C}}\text{H}_2\text{-S}$ ), 33.81 (s,  $\text{C-}\underline{\text{C}}\text{H}_2\text{CH}_3$ ), 34.12 (s,  $\text{C-}\underline{\text{C}}\text{H}_2\text{CH}_3$ ), 43.35 (s,  $\text{S-}\underline{\text{C}}\text{H}_2\text{-C}$ ), 43.44 (s,  $\text{S-}\underline{\text{C}}\text{H}_2\text{-C}$ ), 46.61 (s,  $\text{N}(\underline{\text{C}}\text{H}_2\text{CH}_3)_2$ ), 46.71 (s,  $\text{N}(\underline{\text{C}}\text{H}_2\text{CH}_3)_2$ ), 47.37 (s,  $\text{N}(\underline{\text{C}}\text{H}_2\text{CH}_3)_2$ ), 61.67 (s,  $\text{N-}\underline{\text{C}}\text{H}_2\text{-C}$ ), 61.76 (s,  $\text{N-}\underline{\text{C}}\text{H}_2\text{-C}$ ), 61.91 (s,  $\text{N-}\underline{\text{C}}\text{H}_2\text{-C}$ ), 74.51 (s,  $\underline{\text{C}}\text{-O}$ ), 74.75 (s,  $\underline{\text{C}}\text{-O}$ )

### Gallium tris[1-<sup>t</sup>butylthio-2-((diethylamino)methyl)butan-2-olate] (53):

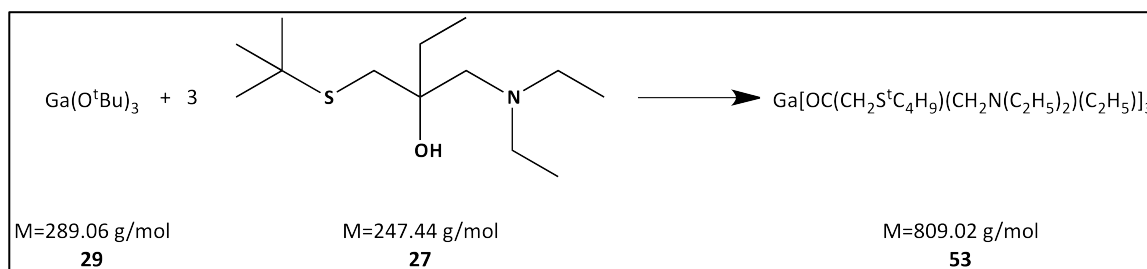

The ligand exchange was carried out similar to the ethyl analogue (**50**) using 0.38 g (1.33 mmol, 1 equiv.)  $\text{Ga}(\text{O}^t\text{Bu})_3$  (**29**) and 1.02 g (4.12 mmol, 1 equiv.) of **27**.

**$^1\text{H}$  NMR ( $\text{CDCl}_3$ , 200 MHz,  $\delta$  [ppm]):** 0.92 (t,  $J=6.79$  Hz, 3H,  $\text{C-CH}_2\text{CH}_3$ ), 0.98-1.15 (m, 6H,  $\text{N}(\text{CH}_2\text{CH}_3)_2$ ), 1.30 (s, 9H,  $\text{C}(\text{CH}_3)_3$ ), 1.38-1.70 (m, 2H,  $\text{C-CH}_2\text{CH}_3$ ), 2.10-3.14 (m, 8H,  $\text{S-CH}_2\text{-C}$ ,  $\text{N-CH}_2\text{-C}$ ,  $\text{N}(\text{CH}_2\text{CH}_3)_2$ )

**$^{13}\text{C}$   $\{^1\text{H}\}$  NMR ( $\text{CDCl}_3$ , 62.86 MHz,  $\delta$  [ppm]):** 7.80 (s,  $\text{C-CH}_2\text{CH}_3$ ), 7.90 (s,  $\text{C-CH}_2\text{CH}_3$ ), 8.09 (s,  $\text{C-CH}_2\text{CH}_3$ ), 8.39 (s,  $\text{C-CH}_2\text{CH}_3$ ), 9.33 (s,  $\text{N}(\text{CH}_2\text{CH}_3)_2$ ), 9.62 (s,  $\text{N}(\text{CH}_2\text{CH}_3)_2$ ), 9.67 (s,  $\text{N}(\text{CH}_2\text{CH}_3)_2$ ), 9.75 (s,  $\text{N}(\text{CH}_2\text{CH}_3)_2$ ), 31.09 (s,  $\text{C}(\text{CH}_3)_3$ ), 33.83 (s,  $\text{C-CH}_2\text{CH}_3$ ), 34.33 (s,  $\text{C-CH}_2\text{CH}_3$ ), 34.41 (s,  $\text{C-CH}_2\text{CH}_3$ ), 37.78 (s,  $\text{S-CH}_2\text{-C}$ ), 38.16 (s,  $\text{S-CH}_2\text{-C}$ ), 38.52 (s,  $\text{S-CH}_2\text{-C}$ ), 41.26 (s,  $\text{C}(\text{CH}_3)_3$ ), 41.49 (s,  $\text{C}(\text{CH}_3)_3$ ), 46.48 (s,  $\text{N}(\text{CH}_2\text{CH}_3)_2$ ), 46.57 (s,  $\text{N}(\text{CH}_2\text{CH}_3)_2$ ), 47.45 (s,  $\text{N}(\text{CH}_2\text{CH}_3)_2$ ), 47.70 (s,  $\text{N}(\text{CH}_2\text{CH}_3)_2$ ), 62.14 (s,  $\text{N-CH}_2\text{-C}$ ), 62.52 (s,  $\text{N-CH}_2\text{-C}$ ), 62.93 (s,  $\text{N-CH}_2\text{-C}$ ), 73.97 (s,  $\text{C-O}$ ), 74.16 (s,  $\underline{\text{C}}\text{-O}$ ), 74.23 (s,  $\underline{\text{C}}\text{-O}$ )

### Indium tris[1-ethoxy-2-((ethoxy)methyl)butan-2-olate] (54):

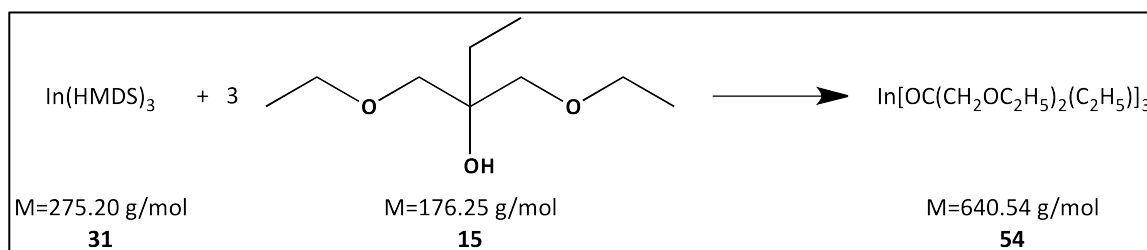

0.30 g (0.50 mmol, 1 equiv.)  $\text{In}(\text{HMDS})_3$  (**31**) were dissolved in approx. 5 ml toluene and 0.27 g (1.55 mmol, 3.05 equiv.) of **15** were added. After 5 h at 50 °C the volume was reduced

to approx. half and then further stirred at 50 °C for 2 d. The amine elimination was almost complete, so all volatiles were removed and a few drops of alcohol added in 1 ml toluene. After 3 h at 50 °C the exchange was complete and all volatiles were removed to yield a non-viscous, clear liquid.

**$^1\text{H}$  NMR ( $\text{CDCl}_3$ , 200 MHz,  $\delta$  [ppm]):** 0.90 (t,  $J=7.39$  Hz, 3H, C- $\text{CH}_2\text{CH}_3$ ), 1.21 (t,  $J=7.00$  Hz, 6H, O- $\text{CH}_2\text{CH}_3$ ), 1.043 (q,  $J=7.25$  Hz, 2H, C- $\text{CH}_2\text{CH}_3$ ), 3.21 (d,  $J=8.51$  Hz, 2H, O- $\text{CH}_2\text{-C}$ ), 3.34 (d,  $J=8.61$  Hz, 2H, O- $\text{CH}_2\text{-C}$ ), 3.66 (m,  $J=3.56$  Hz, 4H, O- $\text{CH}_2\text{CH}_3$ )

**$^{13}\text{C}$  { $^1\text{H}$ } NMR ( $\text{CDCl}_3$ , 62.86 MHz,  $\delta$  [ppm]):** 7.45 (s, C- $\text{CH}_2\text{CH}_3$ ), 14.78 (s, O- $\text{CH}_2\text{CH}_3$ ), 30.05 (s, C- $\text{CH}_2\text{CH}_3$ ), 67.16 (s, O- $\text{CH}_2\text{CH}_3$ ), 71.85 (s,  $\text{C-O}$ ), 74.23 (s, O- $\text{CH}_2\text{-C}$ )

### **Indium tris[1-ethylthio-2-((ethylthio)methyl)butan-2-olate] (55):**

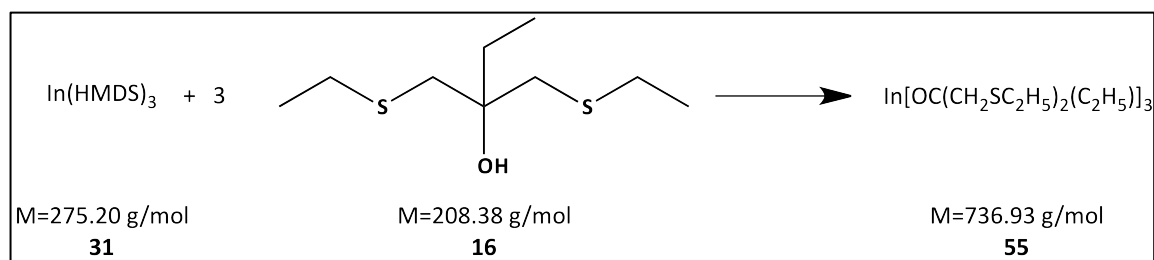

0.47 g (2.25 mmol, 3.05 equiv.) of **16** were added to a solution of 0.44 g (0.74 mmol, 1 equiv.)  $\text{In}(\text{HMDS})_3$  (**31**) in 5 ml toluene. After 1 d at room temperature the amine substitution was complete and all volatiles were removed under reduced pressure.

**$^1\text{H}$  NMR ( $\text{CDCl}_3$ , 200 MHz,  $\delta$  [ppm]):** 0.89 (t,  $J=7.27$  Hz, 3H, C- $\text{CH}_2\text{CH}_3$ ), 1.27 (t,  $J=7.40$  Hz, 6H, S- $\text{CH}_2\text{CH}_3$ ), 1.53 (q,  $J=7.14$  Hz, 2H, C- $\text{CH}_2\text{CH}_3$ ), 2.53-2.95 (m, 8H, S- $\text{CH}_2\text{CH}_3$ , S- $\text{CH}_2\text{-C}$ )

**$^{13}\text{C}$  { $^1\text{H}$ } NMR ( $\text{CDCl}_3$ , 62.86 MHz,  $\delta$  [ppm]):** 8.53 (s, C- $\text{CH}_2\text{CH}_3$ ), 15.01 (s, S- $\text{CH}_2\text{CH}_3$ ), 28.30 (s, S- $\text{CH}_2\text{CH}_3$ ), 34.16 (s, C- $\text{CH}_2\text{CH}_3$ ), 44.01 (s, S- $\text{CH}_2\text{-C}$ ), 73.10 (s,  $\text{C-O}$ )

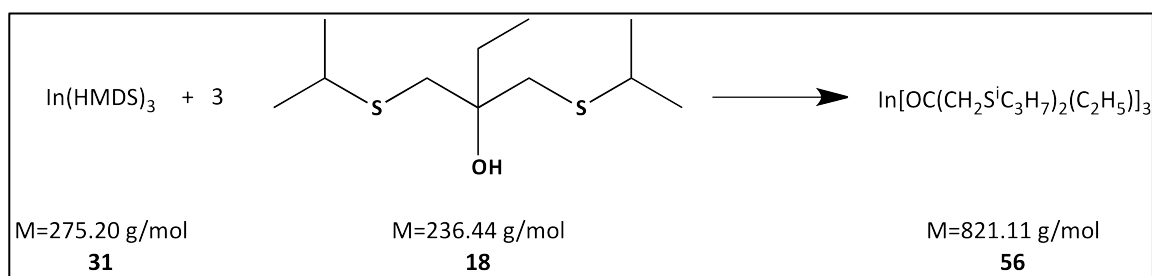

**Indium tris[1-isopropylthio-2-((isopropylthio)methyl)butan-2-olate] (56):**

0.27 g (0.45 mmol, 1 equiv.)  $\text{In}(\text{HMDS})_3$  (**31**) were dissolved in 5 ml toluene before 0.33 g (1.38 mmol, 1 equiv.) **18** were added. After 1 week at room temperature, the reaction volume was concentrated to approx. half and the reaction stirred for another 3 d. After removing all volatiles, little alcohol **18** was added in 1 ml of toluene and stirred over night at 50 °C to complete the ligand exchange. Removal of all volatile species yielded a yellowish, clear liquid.

$^1\text{H}$  NMR ( $\text{CDCl}_3$ , 200 MHz,  $\delta$  [ppm]): 0.90 (t,  $J=7.18$  Hz, 3H, C- $\text{CH}_2\text{CH}_3$ ), 1.31 (dd,  $J=2.31 / 6.54$  Hz, 12H,  $\text{CH}(\text{CH}_3)_2$ ), 1.51 (q,  $J=7.08$  Hz, 2H, C- $\text{CH}_2\text{CH}_3$ ), 2.60 (d,  $J=12.01$  Hz, 2H, S- $\text{CH}_2$ -C), 2.88 (d,  $J=12.01$  Hz, 2H, S- $\text{CH}_2$ -C), 3.11 (m,  $J=6.69$  Hz, 2H,  $\text{CH}(\text{CH}_3)_2$ )

$^{13}\text{C}$  { $^1\text{H}$ } NMR ( $\text{CDCl}_3$ , 62.86 MHz,  $\delta$  [ppm]): 8.42 (s, C- $\text{CH}_2\text{CH}_3$ ), 23.63 (s,  $\text{CH}(\text{CH}_3)_2$ ), 34.36 (s, C- $\text{CH}_2\text{CH}_3$ ), 37.27 (s,  $\text{CH}(\text{CH}_3)_2$ ) 42.49 (s, S- $\text{CH}_2$ -C), 73.40 (s, C-O)

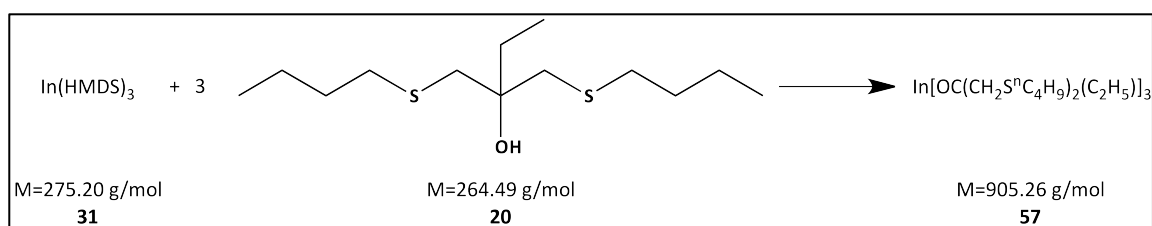
**Indium tris[1-<sup>n</sup>butylthio-2-((<sup>n</sup>butylthio)methyl)butan-2-olate] (57):**

0.31 g (0.52 mmol, 1 equiv.)  $\text{In}(\text{HMDS})_3$  (**31**) in 5 ml toluene were mixed with 0.43 g (1.62 mmol, 1 equiv.) **20** and stirred at 50 °C. After 5 h, part of the volatiles was removed and the reaction stirred further for 2 d at 50 °C. After removal of all volatiles, little amounts of **20** in 1.5 ml of toluene were added to complete the reaction. After 3 h all volatile compounds were removed to give a clear, slightly yellowish, viscous liquid.

$^1\text{H}$  NMR ( $\text{CDCl}_3$ , 200 MHz,  $\delta$  [ppm]): 0.83-0.94 (m, 9H, C- $\text{CH}_2\text{CH}_3$ ,  $\text{CH}_3\text{CH}_2\text{CH}_2$ ), 1.38 (quint.,  $J=7.39$  Hz, 4H,  $\text{CH}_3\text{CH}_2\text{CH}_2$ ), 1.45-1.66 (m, 6H,  $\text{CH}_2\text{CH}_2\text{-S}$ , C- $\text{CH}_2\text{CH}_3$ ), 2.56 (d,  $J=12.18$  Hz, 2H, S- $\text{CH}_2\text{-C}$ ), 2.65 (t,  $J=7.30$  Hz, 4H,  $\text{CH}_2\text{CH}_2\text{-S}$ ), 2.86 (d,  $J=12.08$  Hz, 2H, S- $\text{CH}_2\text{-C}$ )

$^{13}\text{C}$  { $^1\text{H}$ } NMR ( $\text{CDCl}_3$ , 62.86 MHz,  $\delta$  [ppm]): 8.51 (s, C- $\text{CH}_2\text{CH}_3$ ), 13.81 (s,  $\text{CH CH}_2\text{CH}_2$ ), 22.13 (s,  $\text{CH}_3\text{CH}_2\text{CH}_2$ ), 31.99 (s,  $\text{CH}_2\text{CH}_2\text{-S}$ ), 34.01 (s,  $\text{CH}_2\text{CH}_2\text{-S}$ ), 34.14 (s, C- $\text{CH}_2\text{CH}_3$ ), 44.37 (s, S- $\text{CH}_2\text{-C}$ ), 73.04 (s,  $\text{C-O}$ )

### Indium tris[1- $^t$ butylthio-2-(( $^t$ butylthio)methyl)butan-2-olate] (58):

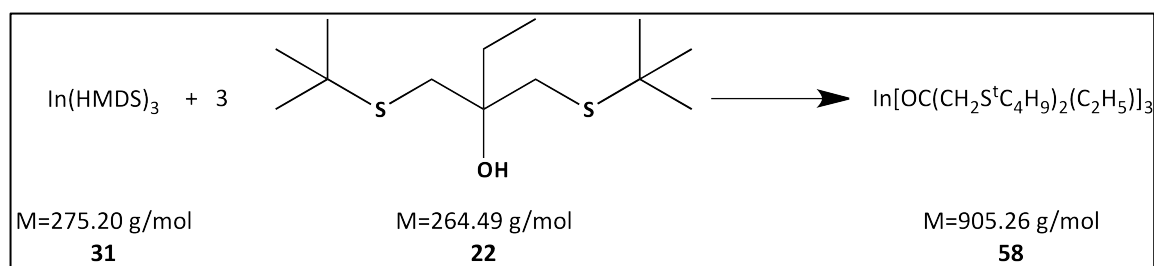

The reaction was conducted identically to the  $^n$ butyl analogue (**57**) using 0.32 g (0.53 mmol, 1 equiv.)  $\text{In}(\text{HMDS})_3$  (**31**) and 0.44 g (1.65 mmol, 1 equiv.) of **22** yielding a yellow, highly viscous liquid. Crystals suitable for XRD experiments were obtained from a concentrated  $^n$ pentane solution.

$^1\text{H}$  NMR ( $\text{CDCl}_3$ , 200 MHz,  $\delta$  [ppm]): 0.95 (t,  $J=7.27$  Hz, 3H, C- $\text{CH}_2\text{CH}_3$ ), 1.39 (s, 18H,  $\text{C}(\text{CH}_3)_3$ ), 1.45-1.64 (m, 2H, C- $\text{CH}_2\text{CH}_3$ ), 2.67 (d,  $J=10.69$  Hz, 2H, S- $\text{CH}_2\text{-C}$ ), 2.93 (d,  $J=11.01$  Hz, 2H, S- $\text{CH}_2\text{-C}$ )

$^{13}\text{C}$  { $^1\text{H}$ } NMR ( $\text{CDCl}_3$ , 62.86 MHz,  $\delta$  [ppm]): 8.30 (s, C- $\text{CH}_2\text{CH}_3$ ), 31.10 (s,  $\text{C}(\text{CH}_3)_3$ ), 34.66 (s, C- $\text{CH}_2\text{CH}_3$ ), 39.59 (s, S- $\text{CH}_2\text{-C}$ ), 43.64 (s,  $\text{C}(\text{CH}_3)_3$ ), 73.31 (s,  $\text{C-O}$ )

### Indium tris[1-diethylamino-2-((ethylthio)methyl)butan-2-olate] (59):

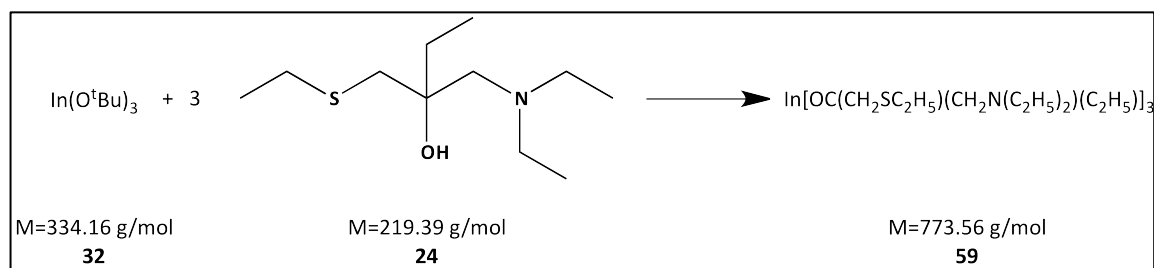

0.64 g (2.90 mmol, 3.1 equiv.) of **24** were added to a solution of 0.31 g (0.937 mmol, 1 equiv.) of  $\text{In}(\text{O}^t\text{Bu})_3$  (**32**) and stirred for 1.5 d at 55 °C. Then, half of the volatiles were removed and the reaction was further stirred for additional 2 d at 55 °C. After removing all volatiles, 3 drops of the ligand in 1 ml toluene were added and after approx. 12 h at 55 °C, the reaction was complete. Removing all volatiles yielded a viscous, clear liquid.

**$^1\text{H}$  NMR ( $\text{CDCl}_3$ , 200 MHz,  $\delta$  [ppm]):** 0.89 (t,  $J=7.05$  Hz, 3H, C- $\text{CH}_2\text{CH}_3$ ), 1.05 (t,  $J=7.06$  Hz, 6H,  $\text{N}(\text{CH}_2\text{CH}_3)_2$ ), 1.23 (t,  $J=7.22$  Hz, 3H, S- $\text{CH}_2\text{CH}_3$ ), 1.32-1.46 (m, 1H, C- $\text{CH}_2\text{CH}_3$ ), 1.47-1.64 (m, 1H, C- $\text{CH}_2\text{CH}_3$ ), 2.23-2.38 (m, 1H, S- $\text{CH}_2\text{-C}$ ), 2.45-2.73 (m, 5H, S- $\text{CH}_2\text{-C}$ , S- $\text{CH}_2\text{CH}_3$ , N- $\text{CH}_2\text{-C}$ ), 2.83 (q,  $J=6.98$  Hz, 4H,  $\text{N}(\text{CH}_2\text{CH}_3)_2$ )

**$^{13}\text{C}$  { $^1\text{H}$ } NMR ( $\text{CDCl}_3$ , 62.86 MHz,  $\delta$  [ppm]):** 8.04 (s, C- $\text{CH}_2\text{CH}_3$ ), 8.32 (s, C- $\text{CH}_2\text{CH}_3$ ), 8.38 (s, C- $\text{CH}_2\text{CH}_3$ ), 9.59 (s,  $\text{N}(\text{CH}_2\text{CH}_3)_2$ ), 9.67 (s,  $\text{N}(\text{CH}_2\text{CH}_3)_2$ ), 15.18 (s, S- $\text{CH}_2\text{CH}_3$ ), 15.22 (s, S- $\text{CH}_2\text{CH}_3$ ), 27.56 (s, S- $\text{CH}_2\text{CH}_3$ ), 27.82 (s, S- $\text{CH}_2\text{CH}_3$ ), 34.48 (s, C- $\text{CH}_2\text{CH}_3$ ), 34.52 (s, C- $\text{CH}_2\text{CH}_3$ ), 35.00 (s, C- $\text{CH}_2\text{CH}_3$ ), 43.93 (s, S- $\text{CH}_2\text{-C}$ ), 43.32 (s, S- $\text{CH}_2\text{-C}$ ), 43.54 (s, S- $\text{CH}_2\text{-C}$ ), 46.90 (s,  $\text{N}(\text{CH}_2\text{CH}_3)_2$ ), 47.37 (s,  $\text{N}(\text{CH}_2\text{CH}_3)_2$ ), 47.53 (s,  $\text{N}(\text{CH}_2\text{CH}_3)_2$ ), 61.18 (s, N- $\text{CH}_2\text{-C}$ ), 61.99 (s, N- $\text{CH}_2\text{-C}$ ), 62.08 (s, N- $\text{CH}_2\text{-C}$ ), 62.42 (s, N- $\text{CH}_2\text{-C}$ ), 72.59 (s, C-O), 73.26 (s, C-O), 73.35 (s, C-O)

### **Indium tris [1-diethylamino-2-((isopropylthio)methyl)butan-2-olate] (60):**

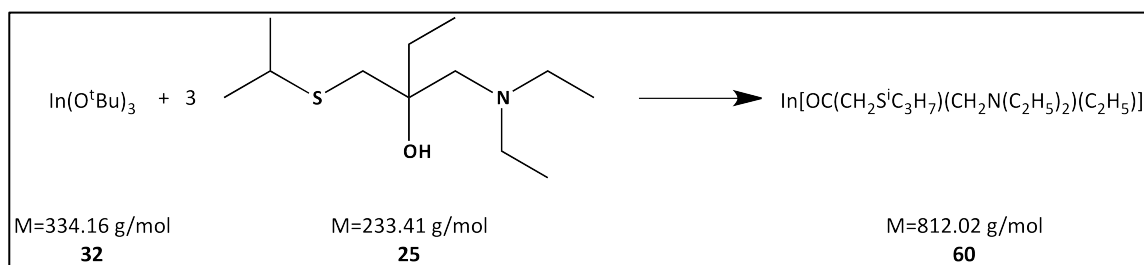

The exchange reaction was carried out similar to the ethyl analogue (**59**) mentioned before using 0.30 g (0.89 mmol, 1 equiv.)  $\text{In}(\text{O}^t\text{Bu})_3$  (**32**) and 0.65 g (2.76 mmol, 3.1 equiv.) of **25** yielding a viscous, lightly yellow, clear liquid.

**$^1\text{H}$  NMR ( $\text{CDCl}_3$ , 200 MHz,  $\delta$  [ppm]):** 0.93 (t,  $J=10.72$  Hz, 3H, C- $\text{CH}_2\text{CH}_3$ ), 1.06 (t,  $J=7.09$  Hz, 4H,  $\text{N}(\text{CH}_2\text{CH}_3)_2$ ), 1.10-1.17 (m, 2H,  $\text{N}(\text{CH}_2\text{CH}_3)_2$ ), 1.25 (d,  $J=6.67$  Hz, 6H,  $\text{CH}(\text{CH}_3)_2$ ), 1.33-1.46 (m, 1H, C- $\text{CH}_2\text{CH}_3$ ), 1.47-1.65 (m, 1H, C- $\text{CH}_2\text{CH}_3$ ), 2.22-2.38 (m, 1H, S- $\text{CH}_2\text{-C}$ ), 2.50-2.72 (m, 3H, S- $\text{CH}_2\text{-C}$ , N- $\text{CH}_2\text{-C}$ ), 2.75-2.99 (m, 5H,  $\text{N}(\text{CH}_2\text{CH}_3)$ ,  $\text{CH}(\text{CH}_3)_2$ )

$^{13}\text{C}$   $\{^1\text{H}\}$  NMR ( $\text{CDCl}_3$ , 62.86 MHz,  $\delta$  [ppm]): 7.96 (s, C-CH $_2$ CH $_3$ ), 8.25 (s, C-CH $_2$ CH $_3$ ), 8.33 (s, C-CH $_2$ CH $_3$ ), 9.59 (s, N(CH $_2$ CH $_3$ ) $_2$ ), 9.64 (s, N(CH $_2$ CH $_3$ ) $_2$ ), 9.69 (s, N(CH $_2$ CH $_3$ ) $_2$ ), 23.76 (s, CH(CH $_3$ ) $_2$ ), 23.85 (s, CH(CH $_3$ ) $_2$ ), 34.57 (s, C-CH $_2$ CH $_3$ ), 34.63 (s, C-CH $_2$ CH $_3$ ), 35.02 (s, C-CH $_2$ CH $_3$ ), 35.12 (s, C-CH $_2$ CH $_3$ ), 36.16 (s, CH(CH $_3$ ) $_2$ ), 36.34 (s, CH(CH $_3$ ) $_2$ ), 36.38 (s, CH(CH $_3$ ) $_2$ ), 41.41 (s, S-CH $_2$ -C), 41.65 (s, S-CH $_2$ -C), 41.81 (s, S-CH $_2$ -C), 42.11 (s, S-CH $_2$ -C), 46.82 (s, N(CH $_2$ CH $_3$ ) $_2$ ), 46.88 (s, N(CH $_2$ CH $_3$ ) $_2$ ), 47.35 (s, N(CH $_2$ CH $_3$ ) $_2$ ), 47.51 (s, N(CH $_2$ CH $_3$ ) $_2$ ), 61.30 (s, N-CH $_2$ -C), 61.37 (s, N-CH $_2$ -C), 62.06 (s, N-CH $_2$ -C), 62.16 (s, N-CH $_2$ -C), 72.29 (s, C-O), 73.24 (s, C-O), 73.35 (s, C-O)

### Indium tris[1-<sup>n</sup>butylthio-2-((diethylamino)methyl)butan-2-olate] (61):

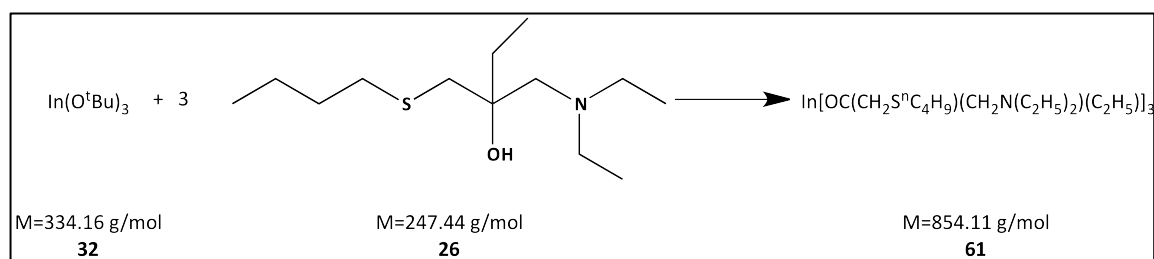

The ligand exchange reaction was carried out similar to the ethyl analogue (**59**) mentioned above while using 0.32 g (0.97 mmol, 1 equiv.)  $\text{In}(\text{O}^t\text{Bu})_3$  (**32**) and 0.74 g (3.01 mmol, 3.1 equiv.) of **26** yielding a clear, viscous liquid.

$^1\text{H}$  NMR ( $\text{CDCl}_3$ , 200 MHz,  $\delta$  [ppm]): 0.90 (t,  $J=7.11$  Hz, 6H, C-CH $_2$ CH $_3$ , CH $_3$ CH $_2$ CH $_2$ ), 1.06 (t,  $J=6.68$  Hz, 4H, N(CH $_2$ CH $_3$ ) $_2$ ), 1.10-1.20 (m, 2H, N(CH $_2$ CH $_3$ ) $_2$ ), 1.32-1.47 (m, 3H, C-CH $_2$ CH $_3$ , CH $_3$ CH $_2$ CH $_2$ ), 1.48-1.62 (m, 3H, C-CH $_2$ CH $_3$ , CH $_2$ CH $_2$ -S), 2.21-2.39 (m, 1H, S-CH $_2$ -C), 2.45-2.71 (m, 5H, S-CH $_2$ -C, CH $_2$ CH $_2$ -S, N-CH $_2$ -C), 2.75-2.94 (m, 4H, N(CH $_2$ CH $_3$ ) $_2$ )

$^{13}\text{C}$   $\{^1\text{H}\}$  NMR ( $\text{CDCl}_3$ , 62.86 MHz,  $\delta$  [ppm]): 8.31 (s, C-CH $_2$ CH $_3$ ), 8.38 (s, C-CH $_2$ CH $_3$ ), 9.58 (s, N(CH $_2$ CH $_3$ ) $_2$ ), 9.68 (s, N(CH $_2$ CH $_3$ ) $_2$ ), 13.85 (s, CH $_3$ CH $_2$ CH $_2$ ), 22.21 (s, CH $_3$ CH $_2$ CH $_2$ ), 32.20 (s, CH $_2$ CH $_2$ -S), 33.74 (s, CH $_2$ CH $_2$ -S), 34.44 (s, C-CH $_2$ CH $_3$ ), 34.49 (s, C-CH $_2$ CH $_3$ ), 43.77 (s, S-CH $_2$ -C), 44.01 (s, S-CH $_2$ -C), 46.84 (s, N(CH $_2$ CH $_3$ ) $_2$ ), 46.90 (s, N(CH $_2$ CH $_3$ ) $_2$ ), 61.95 (s, N-CH $_2$ -C), 62.04 (s, N-CH $_2$ -C), 73.23 (s, C-O), 73.32 (s, C-O)

### Indium tris[1-<sup>t</sup>butylthio-2-((diethylamino)methyl)butan-2-olate] (62):

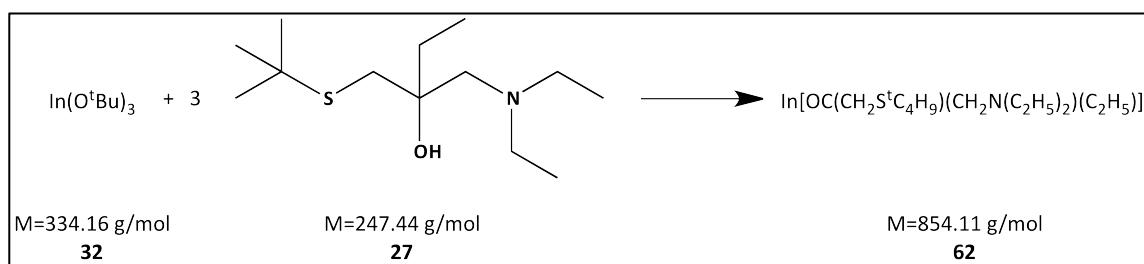

The exchange reaction was carried out similar to the procedure for the ethyl analogue (**59**) using 0.31 g (0.93 mmol, 1 equiv.)  $\text{In}(\text{O}^t\text{Bu})_3$  (**32**) and 0.71 g (2.88 mmol, 3.1 equiv.) of **27** yielding a viscous, colourless liquid.

**$^1\text{H}$  NMR ( $\text{CDCl}_3$ , 200 MHz,  $\delta$  [ppm]):** 0.92 (t,  $J=6.67$  Hz, 3H, C- $\text{CH}_2\text{CH}_3$ ), 1.05 (t,  $J=6.67$  Hz, 5H,  $\text{N}(\text{CH}_2\text{CH}_3)_2$ ), 1.09-1.19 (m, 1H,  $\text{N}(\text{CH}_2\text{CH}_3)_2$ ), 1.29 (s, 9H,  $\text{C}(\text{CH}_3)_3$ ), 1.35-1.63 (m, 2H, C- $\text{CH}_2\text{CH}_3$ ), 2.2-2.36 (m, 1H, S- $\text{CH}_2\text{-C}$ ), 2.50-2.70 (m, 3H, S- $\text{CH}_2\text{-C}$ , N- $\text{CH}_2\text{-N}$ ), 2.78-2.96 (m, 4H,  $\text{N}(\text{CH}_2\text{CH}_3)_2$ )

**$^{13}\text{C}$   $\{^1\text{H}\}$  NMR ( $\text{CDCl}_3$ , 62.86 MHz,  $\delta$  [ppm]):** 87.68 (s, C- $\text{CH}_2\text{CH}_3$ ), 8.04 (s, C- $\text{CH}_2\text{CH}_3$ ), 8.13 (s, C- $\text{CH}_2\text{CH}_3$ ), 9.58 (s,  $\text{N}(\text{CH}_2\text{CH}_3)_2$ ), 9.65 (s,  $\text{N}(\text{CH}_2\text{CH}_3)_2$ ), 31.07 (s,  $\text{C}(\text{CH}_3)_3$ ), 34.74 (s, C- $\text{CH}_2\text{CH}_3$ ), 34.81 (s, C- $\text{CH}_2\text{CH}_3$ ), 35.16 (s, C- $\text{CH}_2\text{CH}_3$ ), 38.83 (s, S- $\text{CH}_2\text{-C}$ ), 39.10 (s, S- $\text{CH}_2\text{-C}$ ), 39.24 (s, S- $\text{CH}_2\text{-C}$ ), 41.42 (s,  $\text{C}(\text{CH}_3)_3$ ), 46.70 (s,  $\text{N}(\text{CH}_2\text{CH}_3)_2$ ), 46.79 (s,  $\text{N}(\text{CH}_2\text{CH}_3)_2$ ), 62.38 (s, N- $\text{CH}_2\text{-C}$ ), 62.48 (s, N- $\text{CH}_2\text{-C}$ ), 71.85 (s,  $\text{C-O}$ ), 73.05 (s,  $\text{C-O}$ ), 73.18 (s,  $\text{C-O}$ )

## LIST OF REFERENCES

---

- [1] S. Mathur, M. Driess in *From Metal-Organic Precursors to Functional Ceramics and Related Nanoscaled Materials, Vol.* (Eds.: R. H., C. D., M. M.P.), Elsevier, Oxford, **2007**, pp.35-70.
- [2] S. Mathur, S. Barth *Small*. **2007**, 3, 2070-2075.
- [3] S. Mathur, S. Barth, U. Werner, F. Hernandez-Ramirez, A. Romano-Rodriguez *Adv. Mater.* **2008**, 20, 1550-1554.
- [4] M. Lomoschitz, H. Peterlik, K. Zorn, S. O. Baumann, U. Schubert *Journal of Materials Chemistry*. **2010**, 20, 5527-5532.
- [5] E. Hemmer, I. Kumakiri, N. Lecerf, R. Bredesen, S. Barth, J. Altmayer, N. Donia, C. Cavellius, K. Soga, S. Mathur *Microporous Mesoporous Mater.* **2012**, 163, 229-236.
- [6] H. Yokoyama, T. Ogiwara, M. Goto in Solid powder cosmetics containing titanium oxide, silica, and mica, Vol. (Ed.^Eds.: Editor), Kobayashi Kose Co., Ltd., Japan . City, **1990**, pp.8.
- [7] S. Yoshida, O. Kumazawa, K. Tahira in Cosmetics containing complex particles of silica and zinc oxide, Vol. (Ed.^Eds.: Editor), Nippon Muki Kagaku Kogyo K. K., Japan . City, **1999**, pp.7.
- [8] G. P. Moss, P. A. S. Smith, D. Tavernier *Pure Appl. Chem.* **1995**, 67, 1307-1375.
- [9] J. C. Brinker, G. W. Scherer, Sol-Gel Science The Physics and Chemistry of Sol-Gel Processing, Academic Press Inc. , Boston, **1990**.
- [10] C. Sanchez, J. Livage, M. Henry, F. Babonneau *J. Non-Cryst. Solids*. **1988**, 100, 65-76.
- [11] W. A. Herrmann, N. W. Huber, O. Runte *Angewandte Chemie, International Edition in English*. **1995**, 34, 2187-2206.
- [12] D. C. Bradley, R. C. Mehrotra, I. P. Rothwel, A. Singh, Alkoxo and Aryloxo Derivatives of Metals, Academic Pr Inc, **2001**.
- [13] R. C. Mehrotra *J. Non-Cryst. Solids*. **1988**, 100, 1-15.
- [14] A. Abraham, R. Prins, J. A. van Bokhoven, E. R. H. Van Eck, A. P. M. Kentgens *J. Phys. Chem. B*. **2006**, 110, 6553-6560.
- [15] R. Lichtenberger, U. Schubert *Journal of Materials Chemistry*. **2010**, 20, 9287-9296.
- [16] K. G. Caulton, L. G. Hubert-Pfalzgraf *Chem. Rev.* **1990**, 90, 969-995.
- [17] D. C. Bradley, M. A. Saad, W. Wardlaw *J. Chem. Soc.* **1954**, 2002-2005.
- [18] R. C. Mehrotra *J. Indian Chem. Soc.* **1955**, 32, 759-762.
- [19] R. C. Mehrotra, A. Singh, S. Sogani *Chemical Reviews (Washington, DC, United States)*. **1994**, 94, 1643-1660.
- [20] S. R. Bindal, V. K. Mathur, R. C. Mehrotra *J. Chem. Soc. A*. **1969**, 863-867.
- [21] D. P. Gaur, G. Srivastava, R. C. Mehrotra *J. Organometal. Chem.* **1973**, 63, 221-231.
- [22] C. J. Carmalt, S. J. King *Coord. Chem. Rev.* **2006**, 250, 682-709.
- [23] J. Hvoslef, H. Hope, B. D. Murray, P. P. Power *J. Chem. Soc., Chem. Commun.* **1983**, 1438-1439.
- [24] M. Veith, N. Lecerf, S. Mathur, H. Shen, S. Huefner *Chem. Mater.* **1999**, 11, 3103-3112.
- [25] L. G. Hubert-Pfalzgraf *Inorg. Chem. Commun.* **2003**, 6, 102-120.

- [26] S. Mathur, M. Veith, T. Ruegamer, E. Hemmer, H. Shen *Chem. Mater.* **2004**, 16, 1304-1312.
- [27] S. Mathur, S. Barth, H. Shen *Chem. Vap. Deposition.* **2005**, 11, 11-16.
- [28] R. G. Jones, G. Karmas, G. A. Martin, Jr., H. Gilman *Journal of the American Chemical Society.* **1956**, 78, 4285-4286.
- [29] J. Kim, S. G. Bott, D. M. Hoffman *Inorg. Chem.* **1998**, 37, 3835-3841.
- [30] M. Lappert, P. Power, A. Protchenko, A. Seeber, *Metal Amide Chemistry*, John Wiley & Sons, Ltd, **2009**.
- [31] S. E. Diamond, F. Mares *J. Organomet. Chem.* **1977**, 142, C55-C57.
- [32] D. C. Bradley, M. H. Chisholm *Acc. Chem. Res.* **1976**, 9, 273-280.
- [33] M. Veith *Adv. Organomet. Chem.* **1990**, 31, 269-300.
- [34] O. Just, W. S. Rees, Jr. *Adv. Mater. Opt. Electron.* **2000**, 10, 213-221.
- [35] M. Veith, S. Hill, V. Huch *European Journal of Inorganic Chemistry.* **1999**, 1343-1350.
- [36] S. Basharat, C. E. Knapp, C. J. Carmalt, S. A. Barnett, D. A. Tocher *New Journal of Chemistry.* **2008**, 32, 1513-1518.
- [37] D. Pugh, L. G. Bloor, S. Sathasivam, I. P. Parkin, C. J. Carmalt *European Journal of Inorganic Chemistry.* **2011**, 1953-1960.
- [38] S. Suh, D. M. Hoffman *Journal of the American Chemical Society.* **2000**, 122, 9396-9404.
- [39] M. Valet, D. M. Hoffman *Chemistry of Materials.* **2001**, 13, 2135-2143.
- [40] I. D. Varma, R. C. Mehrotra *Journal of the Chemical Society (Resumed).* **1960**, 2966-2969.
- [41] D. C. Bradley *Progr. Inorg. Chem. (F. Albert Cotton, editor. Interscience Publishers, Inc.).* **1960**, 2, 303-361.
- [42] D. C. Bradley *Preparative Inorg. Reactions (William L. Jolly, editor. Interscience).* **1965**, 2, 169-186.
- [43] M. Veith, O. Schutt, J. Blin, S. Becker, J. Freres, V. Huch *Z. Anorg. Allg. Chem.* **2002**, 628, 138-146.
- [44] D. Pugh, L. G. Bloor, I. P. Parkin, C. J. Carmalt *Chem.--Eur. J.* **2012**, 18, 6079-6087.
- [45] H. Schumann, M. Frick, B. Heymer, F. Girgsdies *J. Organomet. Chem.* **1996**, 512, 117-126.
- [46] K. H. Thiele, E. Hecht, T. Gelbrich, U. Dumichen *Journal of Organometallic Chemistry.* **1997**, 540, 89-94.
- [47] T. Gelbrich, E. Hecht, K. H. Thiele, J. Sieler *J. Organomet. Chem.* **2000**, 595, 21-30.
- [48] E. Hecht *Z. Anorg. Allg. Chem.* **2000**, 626, 1642-1646.
- [49] A. Keys, T. J. Barbarich, S. G. Bott, A. R. Barron *Dalton.* **2000**, 577-588.
- [50] C. N. McMahan, S. J. Obrey, A. Keys, S. G. Bott, A. R. Barron *Dalton.* **2000**, 2151-2161.
- [51] S. Chitsaz, E. Irvani, B. Neumüller *Z. Anorg. Allg. Chem.* **2002**, 628, 2279-2285.
- [52] O. T. Beachley, Jr., D. J. MacRae, A. Y. Kovalevsky *Organometallics.* **2003**, 22, 1690-1695.
- [53] S. Basharat, C. J. Carmalt, S. J. King, E. S. Peters, D. A. Tocher *Dalton Trans.* **2004**, 3475-3480.
- [54] W. Ziemkowska *Coordination Chemistry Reviews.* **2005**, 249, 2176-2194.
- [55] H. Schumann, S. Dechert, F. Girgsdies, B. Heymer, M. Hummert, J. Y. Hyeon, J. Kaufmann, S. Schutte, S. Wernik, B. C. Wassermann *Zeitschrift Fur Anorganische Und Allgemeine Chemie.* **2006**, 632, 251-263.

- [56] S. Basharat, W. Betchley, C. J. Carmalt, S. Barnett, D. A. Tocher, H. O. Davies *Organometallics*. **2007**, 26, 403-407.
- [57] S. Basharat, C. J. Carmalt, S. A. Barnett, D. A. Tocher, H. O. Davies *Inorg. Chem.* **2007**, 46, 9473-9480.
- [58] S. Basharat, C. J. Carmalt, R. Palgrave, S. A. Barnett, D. A. Tocher, H. O. Davies *Journal of Organometallic Chemistry*. **2008**, 693, 1787-1796.
- [59] C. E. Knapp, C. J. Carmalt, P. F. McMillan, D. A. Wann, H. E. Robertson, D. W. H. Rankin *Dalton Trans.* **2008**, 6880-6882.
- [60] C. E. Knapp, G. Hyett, I. P. Parkin, C. J. Carmalt *Chemistry of Materials*. **2011**, 23, 1719-1726.
- [61] C. E. Knapp, D. A. Wann, A. Bil, J. T. Schirlin, H. E. Robertson, P. F. McMillan, D. W. H. Rankin, C. J. Carmalt *Inorg. Chem. (Washington, DC, U. S.)*. **2012**, 51, 3324-3331.
- [62] B. Neumüller *Chem. Soc. Rev.* **2003**, 32, 50-55.
- [63] M. F. Lappert *J. Chem. Soc.* **1961**, 817-822.
- [64] M. F. Lappert *J. Chem. Soc.* **1962**, 542-548.
- [65] F. O. Cartan, C. N. Caughlan *J. Phys. Chem.* **1960**, 64, 1756-1758.
- [66] H. S. Horowitz, S. J. McLain, A. W. Sleight, J. D. Druliner, P. L. Gai, M. J. VanKavelaar, J. L. Wagner, B. D. Biggs, S. J. Poon *Science (Washington, D. C., 1883-)*. **1989**, 243, 66-69.
- [67] A. C. Jones *Journal of Materials Chemistry*. **2002**, 12, 2576-2590.
- [68] W. A. Herrmann, N. W. Huber *Chemische Berichte*. **1994**, 127, 821-824.
- [69] R. Anwender, F. C. Munck, T. Priermeier, W. Scherer, O. Runte, W. A. Herrmann *Inorg. Chem.* **1997**, 36, 3545-3552.
- [70] L. G. Hubert-Pfalzgraf *Polyhedron*. **1994**, 13, 1181-1195.
- [71] L. G. Hubert-Pfalzgraf, S. Daniele, J. M. Decams, J. Vaissermann *J. Sol-Gel Sci. Technol.* **1997**, 8, 49-53.
- [72] R. J. Errington, J. Ridland, W. Clegg, R. A. Coxall, J. M. Sherwood *Polyhedron*. **1998**, 17, 659-674.
- [73] D. Solis-Ibarra, A. P. Gomora-Figueroa, N. Zavala-Segovia, V. Jancik *European Journal of Inorganic Chemistry*. **2009**, 4564-4571.
- [74] C. Maurer, E. Pittenauer, V. A. Du, G. Allmaier, U. Schubert *Dalton Trans.* **2012**, 41, 2346-2353.
- [75] M. Bosund, K. Mizohata, T. Hakkarainen, M. Putkonen, M. Soederlund, S. Honkanen, H. Lipsanen *Appl. Surf. Sci.* **2009**, 256, 847-851.
- [76] M. Coll, J. Gazquez, A. Palau, M. Varela, X. Obradors, T. Puig *Chem. Mater.* **2012**, 24, 3732-3737.
- [77] A. A. Tahir, K. C. Molloy, M. Mazhar, G. Kociok-Koehn, M. Hamid, S. Dastgir *Inorg. Chem.* **2005**, 44, 9207-9212.
- [78] A. L. Johnson, N. Hollingsworth, G. Kociok-Kohn, K. C. Molloy *Inorg. Chem. (Washington, DC, U. S.)*. **2008**, 47, 12040-12048.
- [79] A. L. Johnson, N. Hollingsworth, G. Kociok-Kohn, K. C. Molloy *Inorg. Chem. (Washington, DC, U. S.)*. **2008**, 47, 9706-9715.
- [80] K. C. Molloy *J. Chem. Res.* **2008**, 549-554.
- [81] M. Shahid, A. A. Tahir, M. Hamid, M. Mazhar, M. Zeller, K. C. Molloy, A. D. Hunter *European Journal of Inorganic Chemistry*. **2009**, 1043-1050.



- [82] N. Hollingsworth, A. L. Johnson, A. Kingsley, G. Kociok-Kohn, K. C. Molloy *Organometallics*. **2010**, 29, 3318-3326.
- [83] G. A. Horley, G. Kociok-Koehn, K. C. Molloy, C. J. Rodriguez, S. Morreale *Z. Anorg. Allg. Chem.* **2012**, 638, 1699-1704.
- [84] C. E. Knapp, A. Kafizas, I. P. Parkin, C. J. Carmalt *Journal of Materials Chemistry*. **2011**, 21, 12644-12649.
- [85] C. E. Knapp, D. Pugh, P. F. McMillan, I. P. Parkin, C. J. Carmalt *Inorg. Chem.* **2011**, 50, 9491-9498.
- [86] P. B. Hitchcock, M. F. Lappert, I. A. MacKinnon *J. Chem. Soc., Chem. Commun.* **1988**, 1557-1558.
- [87] A. W. G. Platt, P. G. Pringle *J. Chem. Soc., Dalton Trans.* **1989**, 1193-1196.
- [88] S.-J. Lin, Y.-C. Ho, H.-M. Gau *J. Chin. Chem. Soc. (Taipei)*. **1999**, 46, 539-543.
- [89] C. D. Beard, L. Carr, M. F. Davis, J. Evans, W. Levason, L. D. Norman, G. Reid, M. Webster *European Journal of Inorganic Chemistry*. **2006**, 4399-4406.
- [90] T. Tatic, K. Meindl, J. Henn, S. K. Pandey, D. Stalke *Chem. Commun. (Cambridge, U. K.)*. **2010**, 46, 4562-4564.
- [91] K. L. Choy *Progress in Materials Science*. **2003**, 48, 57-170.
- [92] D. A. Baxter, M. N. Chisolm, S. Doherty, N. E. Gruhn *Chem. Commun. (Cambridge)*. **1996**, 1129-1130.
- [93] L. A. Miinea, D. M. Hoffman *Journal of Materials Chemistry*. **2000**, 10, 2392-2395.
- [94] N. Hollingsworth, G. Kociok-Koehn, K. C. Molloy, A. L. Sudlow *Dalton Trans.* **2010**, 39, 5446-5452.
- [95] S. Shimada, Y. Takada, J. Tsujino *Surf. Coat. Technol.* **2005**, 199, 72-76.
- [96] Y. Li, S. Shimada, A. Hirose *Chem. Vap. Deposition*. **2006**, 12, 255-258.
- [97] S. Arockiasamy, V. S. Raghunathan, P. A. Premkumar, P. Kuppusami, A. Dasgupta, P. Parameswaran, C. Mallika, K. S. Nagaraja *Chem. Vap. Deposition*. **2007**, 13, 691-697.
- [98] L. G. Hubert-Pfalzgraf, H. Guillon *Appl. Organomet. Chem.* **1998**, 12, 221-236.
- [99] V. K. Kaushik, T. Ganguli, R. Kumar, C. Mukherjee, P. K. Sen *Thin Solid Films*. **2012**, 520, 3505-3509.
- [100] H. Sankur *Thin Solid Films*. **1992**, 218, 161-169.
- [101] Y. Matsumoto, T. Hanajiri, T. Sugano, L. T. T. Tuyen, T. Katoda *Thin Solid Films*. **1995**, 269, 41-46.
- [102] K. Piglmayer, M. Boman, M. Lindstam, R. Chabicoovsky *J. Phys. IV*. **2001**, 11, Pr3/703-Pr703/713.
- [103] A. P. Purdy, A. D. Berry, R. T. Holm, M. Fatemi, D. K. Gaskill *Inorg. Chem.* **1989**, 28, 2799-2803.
- [104] Y. Chi, T.-Y. Chou, Y.-J. Wang, S.-F. Huang, A. J. Carty, L. Scoles, K. A. Udachin, S.-M. Peng, G.-H. Lee *Organometallics*. **2004**, 23, 95-103.
- [105] K. C. Molloy, P. A. Williams *Appl. Organomet. Chem.* **2008**, 22, 560-564.
- [106] M. F. Mahon, K. C. Molloy, J. E. Stanley, D. W. H. Rankin, H. E. Robertson, B. F. Johnston *Appl. Organomet. Chem.* **2005**, 19, 658-671.
- [107] K. L. Choy, *Handbook of Nanostructured Materials and Nanotechnology, Volume 1: Synthesis and Processing*, Academic Press, San Diego (CA), **2000**.

- [108] D. Saulys, V. Joshkin, M. Khoudiakov, T. F. Kuech, A. B. Ellis, S. R. Oktyabrsky, L. McCaughan *J. Cryst. Growth*. **2000**, 217, 287-301.
- [109] E. T. Norton, Jr., C. Amato-Wierda *Chem. Mater.* **2001**, 13, 4655-4660.
- [110] A. E. Turgambaeva, V. V. Krisyuk, P. A. Stabnikov, I. K. Igumenov *J. Organomet. Chem.* **2007**, 692, 5001-5006.
- [111] J. El Boucham, F. Maury, R. Morancho *J. Anal. Appl. Pyrolysis*. **1998**, 44, 153-165.
- [112] T. Nakamura, T. Nishimura, K. Tachibana *J. Electrochem. Soc.* **2004**, 151, C806-C810.
- [113] J. Lee, Y. S. Kim, T. Anderson *ECS Trans.* **2009**, 25, 41-49.
- [114] Z. Mahmood, I. Hussain, R. E. Linney, D. K. Russell *J. Anal. Appl. Pyrolysis*. **1997**, 44, 29-48.
- [115] M. C. Paputa, S. J. W. Price *Can. J. Chem.* **1979**, 57, 3178-3181.
- [116] B. E. Bent, R. G. Nuzzo, L. H. Dubois *Journal of the American Chemical Society*. **1989**, 111, 1634-1644.
- [117] W. Tumas, R. F. Foster, J. I. Brauman *Journal of the American Chemical Society*. **1988**, 110, 2714-2722.
- [118] S. W. Chiu, J. K.-C. Lau, W.-K. Li *J. Phys. Chem. A*. **2001**, 105, 432-441.
- [119] M. Nandi, D. Rhubright, A. Sen *Inorg. Chem.* **1990**, 29, 3065-3066.
- [120] S. Mathur, S. Barth, H. Shen, J.-C. Pyun, U. Werner *Small*. **2005**, 1, 713-717.
- [121] H. Schmidt *J. Non-Cryst. Solids*. **1994**, 178, 302-312.
- [122] A. Detrich, E. Hild, N. Nagy, E. Volentiru, Z. Horvoelgyi *Thin Solid Films*. **2012**, 520, 2537-2544.
- [123] A. J. Maker, B. A. Rose, A. M. Armani *Opt. Lett.* **2012**, 37, 2844-2846.
- [124] N. Hüsing, U. Schubert *Angew. Chem., Int. Ed.* **1998**, 37, 22-45.
- [125] L. Duraes, O. Oliveira, L. Benedini, B. F. O. Costa, B. A. Matos, A. Portugal *J. Phys. Chem. Solids*. **2011**, 72, 678-684.
- [126] W. Kicinski, M. Szala, M. Nita *J. Sol-Gel Sci. Technol.* **2011**, 58, 102-113.
- [127] Z. Z. Xu, C. C. Wang, W. L. Yang, S. K. Fu *J. Mater. Sci.* **2005**, 40, 4667-4669.
- [128] L.-T. Cheng, M.-Y. Tsai, W. J. Tseng, H.-I. Hsiang, F.-S. Yen *Ceram. Int.* **2008**, 34, 337-343.
- [129] L. Znaidi *Mater. Sci. Eng., B*. **2010**, 174, 18-30.
- [130] R. Lichtenberger, Ph.D Thesis, TU Vienna, **2010**.
- [131] U. Schubert *Journal of Materials Chemistry*. **2005**, 15, 3701-3715.
- [132] U. Schubert, N. Hüsing, *Synthesis of Inorganic Materials*, Wiley-VCH, Weinheim, **2012**.
- [133] M. Lomoschitz, H. Peterlik, G. Friedbacher, U. Schubert *Journal of Materials Chemistry*. **2009**, 19, 75-81.
- [134] M. Lomoschitz, S. Edinger, G. Bauer, G. Friedbacher, U. Schubert *Journal of Materials Chemistry*. **2010**, 20, 2075-2078.
- [135] J. Yang, H. Peterlik, M. Lomoschitz, U. Schubert *J. Non-Cryst. Solids*. **2010**, 356, 1217-1227.
- [136] U. Schubert, N. Huesing, A. Lorenz *Chem. Mater.* **1995**, 7, 2010-2027.
- [137] L. Armelao, D. Barreca, G. Bottaro, G. Mattei, C. Sada, E. Tondello *Chem. Mater.* **2005**, 17, 1450-1456.
- [138] Q. Lei, W.-T. Yip *J. Phys. Chem. C*. **2009**, 113, 21130-21138.

- [139] R.-J. Jeng, L.-H. Chan, R.-H. Lee, G.-H. Hsiue, H.-L. Chang *J. Macromol. Sci., Pure Appl. Chem.* **2001**, A38, 1259-1274.
- [140] I. M. Arafa, M. M. Fares, A. S. Barham *Eur. Polym. J.* **2004**, 40, 1477-1487.
- [141] M. H. Chisholm, Z. Zhou *Journal of Materials Chemistry.* **2004**, 14, 3081-3092.
- [142] C. F. de Graauw, J. A. Peters, B. H. van, J. Huskens *Synthesis.* **1994**, 1007-1017.
- [143] K. Krohn *Synthesis.* **1997**, 1115-1127.
- [144] S. Yamasaki, M. Kanai, M. Shibasaki *Chem.--Eur. J.* **2001**, 7, 4066-4072.
- [145] G. Wang, J. Park, X. Kong, P. R. Wilson, Z. Chen, J.-h. Ahn *Cryst. Growth Des.* **2008**, 8, 1940-1944.
- [146] M. Fleischer, H. Meixner *Sens. Actuators, B.* **1995**, B26, 81-84.
- [147] T. Schwebel, M. Fleischer, H. Meixner, C. D. Kohl *Sens. Actuators, B.* **1998**, B49, 46-51.
- [148] M. Ogita, K. Higo, Y. Nakanishi, Y. Hatanaka *Appl. Surf. Sci.* **2001**, 175-176, 721-725.
- [149] R. Binions, C. J. Carmalt, I. P. Parkin, K. F. E. Pratt, G. A. Shaw *Chem. Mater.* **2004**, 16, 2489-2493.
- [150] A. Walsh, J. L. F. Da Silva, S.-H. Wei, C. Körber, A. Klein, L. F. J. Piper, A. DeMasi, K. E. Smith, G. Panaccione, P. Torelli, D. J. Payne, A. Bourlange, R. G. Egdell *Physical Review Letters.* **2008**, 100, 167402.
- [151] P. D. C. King, T. D. Veal, F. Fuchs, C. Y. Wang, D. J. Payne, A. Bourlange, H. Zhang, G. R. Bell, V. Cimalla, O. Ambacher, R. G. Egdell, F. Bechstedt, C. F. McConville *Phys. Rev. B: Condens. Matter Mater. Phys.* **2009**, 79, 205211/205211-205211/205210.
- [152] B. J. Luff, J. S. Wilkinson, G. Perrone *Appl. Opt.* **1997**, 36, 7066-7072.
- [153] J. S. Kim, M. Granstrom, R. H. Friend, N. Johansson, W. R. Salaneck, R. Daik, W. J. Feast, F. Cacialli *J. Appl. Phys.* **1998**, 84, 6859-6870.
- [154] M. J. Alam, D. C. Cameron *Thin Solid Films.* **2002**, 420-421, 76-82.
- [155] A. Cirpan, F. E. Karasz *J. Appl. Polym. Sci.* **2006**, 99, 3125-3129.
- [156] T. Omata, M. Kita, H. Okada, S. Otsuka-Yao-Matsuo, N. Ono, H. Ikawa *Thin Solid Films.* **2006**, 503, 22-28.
- [157] M. Veith, C. Bubel, M. Zimmer *Dalton Trans.* **2011**, 40, 6028-6032.
- [158] S. Major, K. L. Chopra *Sol. Energy Mater.* **1988**, 17, 319-327.
- [159] M. Toki, M. Aizawa *J. Sol-Gel Sci. Technol.* **1997**, 8, 717-720.
- [160] L.-J. Meng, M. P. dos Santos *Thin Solid Films.* **1998**, 322, 56-62.
- [161] N. C. Oldham, C. J. Hill, C. M. Garland, T. C. McGill *J. Vac. Sci. Technol., A.* **2002**, 20, 809-813.
- [162] V. Craciun, D. Craciun, X. Wang, T. J. Anderson, R. K. Singh *Thin Solid Films.* **2004**, 453-454, 256-261.
- [163] H. W. Kim, N. H. Kim *Appl. Phys. A: Mater. Sci. Process.* **2005**, 81, 763-765.
- [164] T. K. Todsén, C. B. Pollard, E. G. Rietz *Journal of the American Chemical Society.* **1950**, 72, 4000-4002.
- [165] Shivani, B. Pujala, A. K. Chakraborti *J. Org. Chem.* **2007**, 72, 3713-3722.
- [166] A. Heydari, M. Mehrdad, A. Maleki, N. Ahmadi *Synthesis.* **2004**, 1563-1565.
- [167] L. C. Dias, A. M. Aguilar, A. G. Salles, Jr., L. J. Steil, W. R. Roush *J. Org. Chem.* **2005**, 70, 10461-10465.
- [168] A. Preciado, P. G. Williams *J. Org. Chem.* **2008**, 73, 9228-9234.
- [169] S. Bhattacharya, S. Singh, V. D. Gupta *J. Chem. Crystallogr.* **2002**, 32, 299-305.

- [170] L. G. Bloor, C. J. Carmalt, D. Pugh *Coord. Chem. Rev.* **2011**, 255, 1293-1318.
- [171] S. Edinger, Master Thesis, TU Vienna, **2013**.
- [172] R. S. Wagner, W. C. Ellis *Appl. Phys. Lett.* **1964**, 4, 89-90.
- [173] E. I. Givargizov *J. Cryst. Growth.* **1975**, 31, 20-30.
- [174] S. Barth, F. Hernandez-Ramirez, J. D. Holmes, A. Romano-Rodriguez *Progress in Materials Science.* **2010**, 55, 563-627.
- [175] C. Tanyeli, A. S. Demir, I. M. Akhmedov, E. Ozgul, C. G. Kandemir *Synthetic Communications.* **1996**, 26, 2967-2980.
- [176] A. T. Guseinova, K. I. Alieva, I. A. Rzaeva, A. M. Magerramov, I. A. Aliev, V. M. Farzaliev, M. A. Allakhverdiev *Russ. J. Appl. Chem.* **2009**, 82, 1587-1591.

## LIST OF FIGURES, SCHEMES AND TABLES

Figure 1: Structures of: (a) $[\text{Al}(\text{OEt})_3]_n$ , (b) $[\text{Al}(\text{O}^i\text{Pr})_3]_4$ , (c) $[\text{Al}(\text{O}^t\text{Bu})_3]_2$ and (d) $[\text{U}^i\text{Pr})_5]_2$ . <sup>[12]</sup> .....	14
Figure 2: Conformations of alkoxo groups: (a) terminal, (b) $\mu_2$ -bridging, (c) $\mu_3$ -bridging. <sup>[11]</sup> .....	15
Figure 3: Various types of donor-functionalisation: (a) bidentate, (b,c) tridentate, (d) $\beta$ -diketonate, D = donor.....	24
Figure 4: Fundamental steps of a CVD process.....	28
Figure 5: Synthesis approach for secondary alcohols. ....	38
Figure 6: $^1\text{H}$ spectrum of compound <b>3</b> . Inlet shows the magnified region of the spectrum for protons b,c and e.....	40
Figure 7: Attempted synthesis of tertiary alcohols (a), retrosynthetic approach (b), D = donor. ....	41
Figure 8: Synthesis of tertiary alcohols. ....	42
Figure 9: EIMS spectra of compounds <b>25</b> , <b>4</b> , <b>18</b> .....	43
Figure 10: Alkoxide synthesis.....	45
Figure 11: $^1\text{H}$ NMR spectra of compound <b>7</b> (a) and <b>40</b> (b).....	47
Figure 12: $^{13}\text{C}$ NMR spectra of compounds <b>7</b> (a) and <b>40</b> (b). ....	47
Figure 13: $^{13}\text{C}$ NMR spectra of compounds <b>48</b> (a) and <b>34</b> (b). ....	48
Figure 14: $^1\text{H}$ NMR spectra of compounds <b>4</b> (a) and <b>36</b> (b). ....	49
Figure 15: $^{13}\text{C}$ NMR spectra of compounds <b>8</b> (a) and <b>37</b> (b). ....	50
Figure 16: $^{13}\text{C}$ NMR spectra of <b>47</b> (a), <b>18</b> (b) and <b>56</b> (c). ....	51
Figure 17: $^1\text{H}$ NMR spectra of compounds <b>15</b> (a) and <b>54</b> (b). ....	53
Figure 18: $^1\text{H}$ spectrum of compounds <b>27</b> (a) and <b>62</b> (b). ....	54
Figure 19: $^{13}\text{C}$ NMR spectra of compounds <b>27</b> (a) and <b>62</b> (b). ....	54
Figure 20: Preliminary crystal structure of compound <b>58</b> . Hydrogen atoms are omitted for clarity.....	55
Figure 21: TGA measurements of compounds <b>39</b> and <b>53</b> .....	58
Figure 22: TGA measurements of compounds <b>34</b> , <b>40</b> , <b>48</b> and <b>57</b> .....	60
Figure 23: Schematic illustration of the CVD apparatus. <sup>[171]</sup> .....	61
Figure 24: SEM pictures of $\text{In}_2\text{O}_3$ films deposited at 350 °C (a), 500 °C (b) and 650 °C (c).....	62
Figure 25: XRD diffractograms of the $\text{In}_2\text{O}_3$ films. ....	63
Scheme 1: Direct synthesis for the formation of alkoxides. ....	16
Scheme 2: Reaction of halide with alcohol.....	17
Scheme 3: Halide substitution in presence of a base. ....	17
Scheme 4: Mechanism of base-assisted halide substitution. ....	18
Scheme 5: Metathesis reaction. ....	18
Scheme 6: Alcoholysis of metal amides.....	19

Scheme 7: Example for the formation of heteroleptic alkoxides using amide intermediates.	20
Scheme 8: Alcohol interchange reactions. ....	20
Scheme 9: Alkoxide synthesis using metal hydrides. ....	21
Scheme 10: Reaction of an alcohol with metal alkyls. ....	21
Scheme 11: Transesterification reaction for alkoxide synthesis. ....	22
Scheme 12: Proposed mechanism for transesterification reactions. <sup>[12]</sup> ....	23
Scheme 13: Reactions of hydroxides and oxides to form alkoxides. ....	23
Scheme 14: Possible pyrolysis pathways for titanium-alkoxides: ether formation (a), β-hydride elimination (b) and β-hydride transfer (c).....	30
Scheme 15: Main reactions of the sol-gel process shown for Si precursors: (a) hydrolysis, (b) oxolation, (c) alkoxolation.....	31
Scheme 16: Alkoxide mediated Meerwein-Ponndorf-Verley reduction reaction. ....	34
Table 1: Crystal data of compound <b>58</b> . ....	56
Table 2: TGA results of the synthesised alkoxides. The abbreviations merely show the heteroatom containing side chains attached to the alcohol.....	59

## LIST OF COMPOUNDS

Nr.	Name	Molecular formula
1	1-Chloro-3-isopropylthioprop-2-ol	$(\text{ClCH}_2)(\text{}^i\text{C}_3\text{H}_7\text{SCH}_2)\text{CHOH}$
2	2-((Isopropylthio)methyl)oxirane	$(\text{}^i\text{C}_3\text{H}_7\text{SCH}_2)\text{CHCH}_2\text{O}$
3	1,3-Bis(isopropylthio)propan-2-ol	$(\text{}^i\text{C}_3\text{H}_7\text{SCH}_2)_2\text{CHOH}$
4	1-Diethylamino-3-(isopropylthio)propan-2-ol	$(\text{}^i\text{C}_3\text{H}_7\text{SCH}_2)((\text{C}_2\text{H}_5)_2\text{N})\text{CHOH}$
5	1- <sup>n</sup> Butylthio-3-chloropropan-2-ol	$(\text{ClCH}_2)(\text{}^n\text{C}_4\text{H}_9\text{SCH}_2)\text{CHOH}$
6	2-(( <sup>n</sup> Butylthio)methyl)oxirane	$(\text{}^n\text{C}_4\text{H}_9\text{SCH}_2)\text{CHCH}_2\text{O}$
7	1,3-Bis( <sup>n</sup> butylthio)propan-2-ol	$(\text{}^n\text{C}_4\text{H}_9\text{SCH}_2)_2\text{CHOH}$
8	1- <sup>n</sup> Butylthio-3-(diethylamino)propan-2-ol	$(\text{}^n\text{C}_4\text{H}_9\text{SCH}_2)((\text{C}_2\text{H}_5)_2\text{N})\text{CHOH}$
9	1- <sup>t</sup> Butylthio-3-chloropropan-2-ol	$(\text{ClCH}_2)(\text{}^t\text{C}_4\text{H}_9\text{SCH}_2)\text{CHOH}$
10	2-(( <sup>t</sup> Butylthio)methyl)oxirane	$(\text{}^t\text{C}_4\text{H}_9\text{SCH}_2)\text{CHCH}_2\text{O}$
11	1,3-Bis( <sup>t</sup> butylthio)propan-2-ol	$(\text{}^t\text{C}_4\text{H}_9\text{SCH}_2)_2\text{CHOH}$
12	1- <sup>t</sup> Butylthio-3-(diethylamino)propan-2-ol	$(\text{}^t\text{C}_4\text{H}_9\text{SCH}_2)((\text{C}_2\text{H}_5)_2\text{N})\text{CHOH}$
13	1-Chloro-2-(chloromethyl)butan-2-ol	$(\text{ClCH}_2)_2(\text{C}_2\text{H}_5)\text{COH}$
14	2-Chloromethyl-2-ethyloxirane	$(\text{ClCH}_2)(\text{C}_2\text{H}_5)\text{CCH}_2\text{O}$
15	1-Ethyloxy-2-((ethyloxy)methyl)butan-2-ol	$(\text{C}_2\text{H}_5)(\text{C}_2\text{H}_5\text{OCH}_2)_2\text{COH}$
16	1-Ethylthio-2-((ethylthio)methyl)butan-2-ol	$(\text{C}_2\text{H}_5)(\text{C}_2\text{H}_5\text{SCH}_2)_2\text{COH}$
17	2-Ethyl-2-((ethylthio)methyl)oxirane	$(\text{C}_2\text{H}_5)(\text{C}_2\text{H}_5\text{SCH}_2)\text{CCH}_2\text{O}$
18	1-Isopropylthio-2-((isopropylthio)methyl)butan-2-ol	$(\text{C}_2\text{H}_5)(\text{}^i\text{C}_3\text{H}_7\text{SCH}_2)_2\text{COH}$
19	2-Ethyl-2-((isopropylthio)methyl)oxirane	$(\text{C}_2\text{H}_5)(\text{}^i\text{C}_3\text{H}_7\text{SCH}_2)\text{CCH}_2\text{O}$
20	1- <sup>n</sup> Butylthio-2-(( <sup>n</sup> butylthio)methyl)butan-2-ol	$(\text{C}_2\text{H}_5)(\text{}^n\text{C}_4\text{H}_9\text{SCH}_2)_2\text{COH}$
21	2-(( <sup>n</sup> Butylthio)methyl)-2-ethyloxirane	$(\text{C}_2\text{H}_5)(\text{}^n\text{C}_4\text{H}_9\text{SCH}_2)\text{CCH}_2\text{O}$
22	1- <sup>t</sup> Butylthio-2-(( <sup>t</sup> butylthio)methyl)butan-2-ol	$(\text{C}_2\text{H}_5)(\text{}^t\text{C}_4\text{H}_9\text{SCH}_2)_2\text{COH}$
23	2-(( <sup>t</sup> Butylthio)methyl)-2-ethyloxirane	$(\text{C}_2\text{H}_5)(\text{}^t\text{C}_4\text{H}_9\text{SCH}_2)\text{CCH}_2\text{O}$
24	1-Diethylamino-2-((ethylthio)methyl)butan-2-ol	$(\text{C}_2\text{H}_5)(\text{C}_2\text{H}_5\text{SCH}_2)((\text{C}_2\text{H}_5)_2\text{NCH}_2)\text{COH}$
25	1-Diethylamino-2-((isopropylthio)methyl)butan-2-ol	$(\text{C}_2\text{H}_5)(\text{}^i\text{C}_3\text{H}_7\text{SCH}_2)((\text{C}_2\text{H}_5)_2\text{NCH}_2)\text{COH}$
26	1- <sup>n</sup> Butylthio-2-((diethylamino)methyl)butan-2-ol	$(\text{C}_2\text{H}_5)(\text{}^n\text{C}_4\text{H}_9\text{SCH}_2)((\text{C}_2\text{H}_5)_2\text{NCH}_2)\text{COH}$
27	1- <sup>t</sup> Butylthio-2-((diethylamino)methyl)butan-2-ol	$(\text{C}_2\text{H}_5)(\text{}^t\text{C}_4\text{H}_9\text{SCH}_2)((\text{C}_2\text{H}_5)_2\text{NCH}_2)\text{COH}$
28	Potassium tert.-butanolate	$\text{KO}^t\text{Bu}$
29	Gallium tris(tert.-butanolate)	$\text{Ga}(\text{O}^t\text{Bu})_3$
30	Lithium hexamethyldisilazane	$\text{Li}[\text{N}(\text{SiMe}_3)_2]$

Nr.	Name	Molecular formula
31	Indium tris[hexamethyldisilazane]	$\text{In}[\text{N}(\text{SiMe}_3)_2]_3$
32	Indium tris(tert.-butanolate)	$\text{In}(\text{O}^t\text{Bu})_3$
33	Gallium tris[1,3-bis(isopropylthio)propan-2-olate]	$\text{Ga}[\text{OCH}(\text{CH}_2\text{S}^i\text{C}_3\text{H}_7)_2]_3$
34	Gallium tris[1,3-bis( <sup>n</sup> butylthio)propan-2-olate]	$\text{Ga}[\text{OCH}(\text{CH}_2\text{S}^n\text{C}_4\text{H}_9)_2]_3$
35	Gallium tris[1,3-bis( <sup>t</sup> butylthio)propan-2-olate]	$\text{Ga}[\text{OCH}(\text{CH}_2\text{S}^t\text{C}_4\text{H}_9)_2]_3$
36	Gallium tris[1-diethylamino-3-(isopropylthio)propan-2-olate]	$\text{Ga}[\text{OCH}(\text{CH}_2\text{S}^i\text{C}_3\text{H}_7)(\text{CH}_2\text{N}(\text{C}_2\text{H}_5)_2)]_3$
37	Gallium tris[1- <sup>n</sup> butylthio-3-(diethylamino)propan-2-olate]	$\text{Ga}[\text{OCH}(\text{CH}_2\text{S}^n\text{C}_4\text{H}_9)(\text{CH}_2\text{N}(\text{C}_2\text{H}_5)_2)]_3$
38	Gallium tris[1- <sup>t</sup> butylthio-3-(diethylamino)propan-2-olate]	$\text{Ga}[\text{OCH}(\text{CH}_2\text{S}^t\text{C}_4\text{H}_9)(\text{CH}_2\text{N}(\text{C}_2\text{H}_5)_2)]_3$
39	Indium tris[1,3-bis(isopropylthio)propan-2-olate]	$\text{In}[\text{OCH}(\text{CH}_2\text{S}^i\text{C}_3\text{H}_7)_2]_3$
40	Indium tris[1,3-bis( <sup>n</sup> butylthio)propan-2-olate]	$\text{In}[\text{OCH}(\text{CH}_2\text{S}^n\text{C}_4\text{H}_9)_2]_3$
41	Indium tris[1,3-bis( <sup>t</sup> butylthio)propan-2-olate]	$\text{In}[\text{OCH}(\text{CH}_2\text{S}^t\text{C}_4\text{H}_9)_2]_3$
42	Indium tris[1-diethylamino-3-(isopropylthio)propan-2-olate]	$\text{In}[\text{OCH}(\text{CH}_2\text{S}^i\text{C}_3\text{H}_7)(\text{CH}_2\text{N}(\text{C}_2\text{H}_5)_2)]_3$
43	Indium tris[1- <sup>n</sup> butylthio-3-(diethylamino)propan-2-olate]	$\text{In}[\text{OCH}(\text{CH}_2\text{S}^n\text{C}_4\text{H}_9)(\text{CH}_2\text{N}(\text{C}_2\text{H}_5)_2)]_3$
44	Indium tris[1- <sup>t</sup> butylthio-3-(diethylamino)propan-2-olate]	$\text{In}[\text{OCH}(\text{CH}_2\text{S}^t\text{C}_4\text{H}_9)(\text{CH}_2\text{N}(\text{C}_2\text{H}_5)_2)]_3$
45	Gallium tris[1-ethoxy-2-((ethoxy)methyl)butan-2-olate]	$\text{Ga}[\text{OC}(\text{CH}_2\text{OC}_2\text{H}_5)_2(\text{C}_2\text{H}_5)]_3$
46	Gallium tris[1-ethylthio-2-((ethylthio)methyl)butan-2-olate]	$\text{Ga}[\text{OC}(\text{CH}_2\text{SC}_2\text{H}_5)_2(\text{C}_2\text{H}_5)]_3$
47	Gallium tris[1-isopropylthio-2-((isopropylthio)methyl)butan-2-olate]	$\text{Ga}[\text{OC}(\text{CH}_2\text{S}^i\text{C}_3\text{H}_7)_2(\text{C}_2\text{H}_5)]_3$
48	Gallium tris[1- <sup>n</sup> butylthio-2-(( <sup>n</sup> butylthio)methyl)butan-2-olate]	$\text{Ga}[\text{OC}(\text{CH}_2\text{S}^n\text{C}_4\text{H}_9)_2(\text{C}_2\text{H}_5)]_3$
49	Gallium tris[1- <sup>t</sup> butylthio-2-(( <sup>t</sup> butylthio)methyl)butan-2-olate]	$\text{Ga}[\text{OC}(\text{CH}_2\text{S}^t\text{C}_4\text{H}_9)_2(\text{C}_2\text{H}_5)]_3$
50	Gallium tris[1-diethylamino-2-((ethylthio)methyl)butan-2-olate]	$\text{Ga}[\text{OC}(\text{CH}_2\text{SC}_2\text{H}_5)(\text{CH}_2\text{N}(\text{C}_2\text{H}_5)_2)(\text{C}_2\text{H}_5)]_3$
51	Gallium tris [1-diethylamino-2-((isopropylthio)methyl)butan-2-olate]	$\text{Ga}[\text{OC}(\text{CH}_2\text{S}^i\text{C}_3\text{H}_7)(\text{CH}_2\text{N}(\text{C}_2\text{H}_5)_2)(\text{C}_2\text{H}_5)]_3$
52	Gallium tris[1- <sup>n</sup> butylthio-2-((diethylamino)methyl)butan-2-olate]	$\text{Ga}[\text{OC}(\text{CH}_2\text{S}^n\text{C}_4\text{H}_9)(\text{CH}_2\text{N}(\text{C}_2\text{H}_5)_2)(\text{C}_2\text{H}_5)]_3$
53	Gallium tris[1- <sup>t</sup> butylthio-2-((diethylamino)methyl)butan-2-olate]	$\text{Ga}[\text{OC}(\text{CH}_2\text{S}^t\text{C}_4\text{H}_9)(\text{CH}_2\text{N}(\text{C}_2\text{H}_5)_2)(\text{C}_2\text{H}_5)]_3$



Nr.	Name	Molecular formula
54	Indium tris[1-ethyloxy-2-((ethyloxy)methyl)butan-2-olate]	$\text{In}[\text{OC}(\text{CH}_2\text{OC}_2\text{H}_5)_2(\text{C}_2\text{H}_5)]_3$
55	Indium tris[1-ethylthio-2-((ethylthio)methyl)butan-2-olate]	$\text{In}[\text{OC}(\text{CH}_2\text{SC}_2\text{H}_5)_2(\text{C}_2\text{H}_5)]_3$
56	Indium tris[1-isopropylthio-2-((isopropylthio)methyl)butan-2-olate]	$\text{In}[\text{OC}(\text{CH}_2\text{S}^i\text{C}_3\text{H}_7)_2(\text{C}_2\text{H}_5)]_3$
57	Indium tris[1- <sup>n</sup> butylthio-2-(( <sup>n</sup> butylthio)methyl)butan-2-olate]	$\text{In}[\text{OC}(\text{CH}_2\text{S}^n\text{C}_4\text{H}_9)_2(\text{C}_2\text{H}_5)]_3$
58	Indium tris[1- <sup>t</sup> butylthio-2-(( <sup>t</sup> butylthio)methyl)butan-2-olate]	$\text{In}[\text{OC}(\text{CH}_2\text{S}^t\text{C}_4\text{H}_9)_2(\text{C}_2\text{H}_5)]_3$
59	Indium tris[1-diethylamino-2-((ethylthio)methyl)butan-2-olate]	$\text{In}[\text{OC}(\text{CH}_2\text{SC}_2\text{H}_5)(\text{CH}_2\text{N}(\text{C}_2\text{H}_5)_2)(\text{C}_2\text{H}_5)]_3$
60	Indium tris [1-diethylamino-2-((isopropylthio)methyl)butan-2-olate]	$\text{In}[\text{OC}(\text{CH}_2\text{S}^i\text{C}_3\text{H}_7)(\text{CH}_2\text{N}(\text{C}_2\text{H}_5)_2)(\text{C}_2\text{H}_5)]_3$
61	Indium tris[1- <sup>n</sup> butylthio-2-((diethylamino)methyl)butan-2-olate]	$\text{In}[\text{OC}(\text{CH}_2\text{S}^n\text{C}_4\text{H}_9)(\text{CH}_2\text{N}(\text{C}_2\text{H}_5)_2)(\text{C}_2\text{H}_5)]_3$
62	Indium tris[1- <sup>t</sup> butylthio-2-((diethylamino)methyl)butan-2-olate]	$\text{In}[\text{OC}(\text{CH}_2\text{S}^t\text{C}_4\text{H}_9)(\text{CH}_2\text{N}(\text{C}_2\text{H}_5)_2)(\text{C}_2\text{H}_5)]_3$